

Selecting LED Lighting

When selecting lighting for your project, there are several factors to consider. We've made it easy and listed questions below to consider when selecting the best product for your application.

Find yourself needing additional help with product selection? Contact our friendly Design Services team at 866-848-9094 or e-mail DesignAndSupport@TaskLighting.com.

Design By: Artistic Cabinetry

- 1 What is the price range for this project?
- 2 What is the primary intended use of the lighting? Is it for task lighting to illuminate a work area? Or maybe accent lighting to illuminate a specific spot or object? Or are you looking for general lighting or ambient lighting?
- 3 What space is available for mounting the lighting? Is there enough room for a fixture, or does this need to be tape lighting to cut to the right length?
- 4 What is the impact of the color and reflectivity of surrounding surfaces (backsplash, cabinets, countertop, paint) in choosing Kelvin temperature of the fixture?
- 5 Would you like to be able to adjust the white color temperature based upon mood, time of day, task, or after you've installed everything else to get the right white lighting for your space?
- 6 What is the availability of electricity? Are there any obstructions (such as doorways or windows) in running power to the lighting?



Design By: Artistic Cabinetry



Set lights to Warm White in the morning



Then change to Cool White in the afternoon

- 7 Do you plan to just switch the lights on/off, or do you want the option to dim them?

- 8 Where do you want to locate a switch or a dimmer? Do you want or need multiple locations to control your lighting?

- 9 Are you interested in a fixture that combines LED Lighting and receptacles into one? Mounted under the cabinet against the backsplash, the Lighted Power Strip provides task lighting for the countertop, with built-in outlets for appliances, switches for garbage disposal, and lights. Your backsplash remains clean and uninterrupted by outlets and switches!

- 10 Is this a new construction job, or a remodel?

- 11 Would you like the option to control your lighting via a Smart Home device?

Once you have your answers to these questions, if you need help finding products that match your answers, contact our friendly Design Services team for complementary assistance.

Customer layout submitted to Design Services

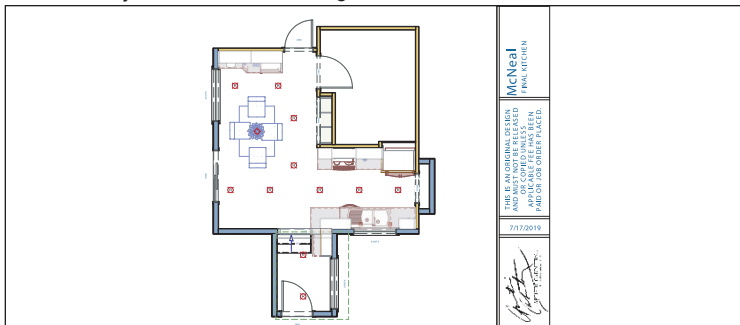

Layout sent back to customer from Design Services with suggested under cabinet lighting

QUANTITY	SYMBOL	ITEM NUMBER	
1	[Symbol]	SOS-12000-400 12" semiLED fixture	
1	[Symbol]	SOS-18000-400 18" semiLED fixture	
2	[Symbol]	SOS-24000-400 24" semiLED fixture	
3	[Symbol]	SOS-30000-400 30" semiLED fixture	
2	[60]	T-60W-12-WP-4W 60 watt waterproof flushmount power supply	
2	[REC]	T-Q-WR96 96 watt receiver	
1	[Symbol]	T-CW205-50L-25 20 gauge solid grey jacket, 25 ft cord	
5	[Symbol]	Mitre joint not indicated on floor plan	SOS-WW400-40 semiLED mitre joint
1	[Symbol]	Mitre joint not indicated on floor plan	SOS-WW40-40 semiLED MitreWay

Layout sent back to customer from Design Services with suggested Angle Power Strip fixtures

QUANTITY	SYMBOL	ITEM NUMBER	
2	[Symbol]	TR8-2WD-P-WT 18" TR Series Angle Power Strip with white device, white finish	
1	[Symbol]	TR30-2WD-P-WT 18" TR Series Angle Power Strip with white device, white finish	
2	[Symbol]	CUSTOM TR 30" 30" TR Series Angle Power Strip white finish	
2	[Symbol]	SS9Q-24008-40 24-1/2" semiLED angled strip light	
1	[REC]	T-Q-WR96 96 watt receiver	
POWER SUPPLY LISTED ON UNDER CABINET PARTS LIST			

Final installation photo based on layout by Design Services

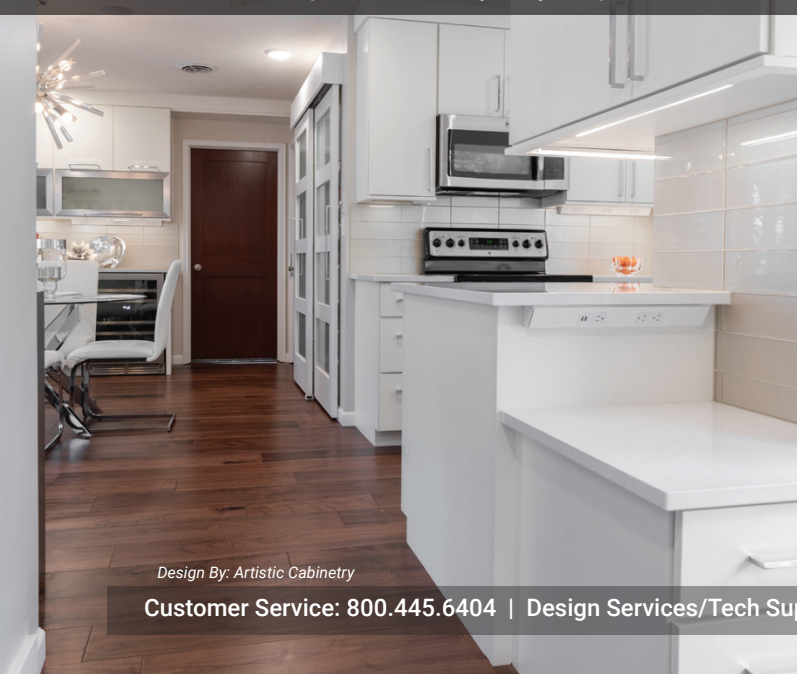

Final installation photo based on layout by Design Services



Design By: Artistic Cabinetry

Design By: Artistic Cabinetry

Selecting Lighting

Face frame under cabinet

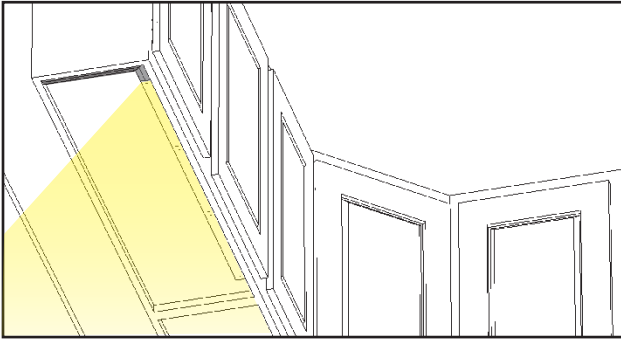

Light mounts at front of cabinet

When lighting your kitchen, use under cabinet lighting to complement your overhead lighting. This is especially great for providing focused illumination on your kitchen work area and highlighting your backsplash.

Under cabinet lighting helps eliminate shadows in the work area.

NOTE: The products listed are the top recommendations for this application. Call Design Services at 866-848-9094 for additional product recommendations.

Linear Fixture sempriaLED SG9 Series page 60

- Higher light output
- Premium fixture for under cabinet – mount at the front of the cabinet
- WireWay available in multiple colors

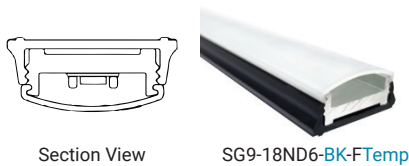

Section View

SG9-18ND6-BK-FTemp

Mini Linear Fixture sempriaLED F Series page 62

- High and medium light output available
- Mini profile, easy to hide fixture
- Mount at the front of the cabinet



Section View

SF9Q-12ND4-FTemp

Single Color Tape Light or Linear Fixture illumaled Vivid Series page 110

- Single Color, high light output
- 36 diodes per foot
- Available as tape lighting, tape lighting with profile (unassembled), or as assembled linear fixtures

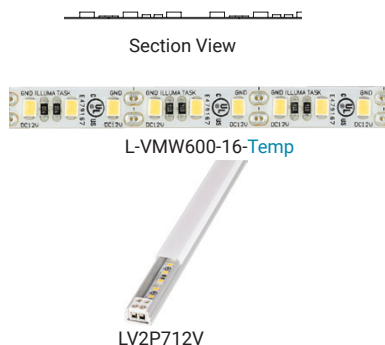

Section View

L-VMW600-16-Temp

LV2P712V

Lighted Power Strip LPS RM Series page 40 & LPS DV Series page 38

- Higher light output available
- Lighting and power combined into one fixture
- Mounts at the back of the cabinet

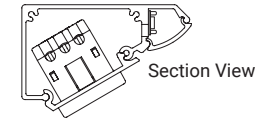

Section View



LP18HR9NDBBZTemp



LP18QD4NDGSNTemp

Tunable White Tape Light or Linear Fixture TandemLED Series page 80

- Tunable White, high light output
- 88 diodes per foot
- Available as tape lighting, tape lighting with profile (unassembled), or as assembled linear fixtures

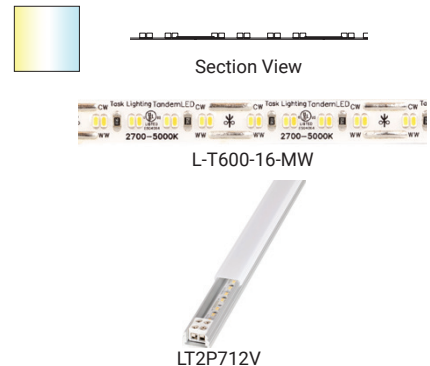

Section View

L-T600-16-MW

LV2P712V

120V Bar Light page 188

- Higher light output
- Premium fixture for under cabinet
- Mount at the back of the cabinet

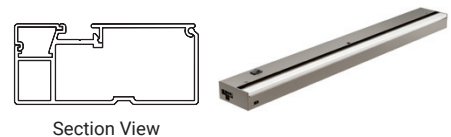

Section View

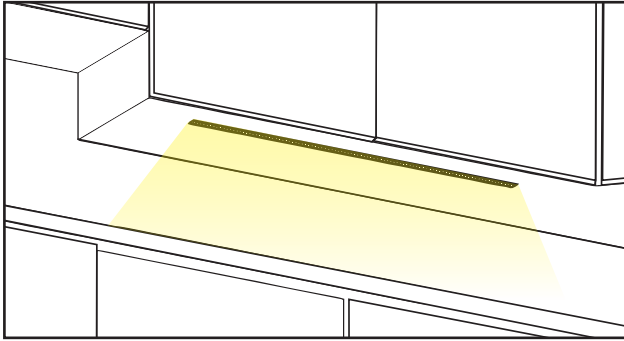

Light mounts at front of cabinet

When lighting your kitchen, use under cabinet lighting to complement your overhead lighting and eliminate shadows on the work surface. The lighting provides focused illumination for the countertop and highlights your backsplash.

For frameless cabinetry, use a light rail moulding to hide the strip light fixture or use recessed puck lights, recessed strip light fixtures, or recessed tape light housing for flush mount installations.

Recessed Linear Fixture sempriaLED R Series page 68

- High or higher light output available
- Premium recessed fixture for under cabinet – mount at the front of the cabinet

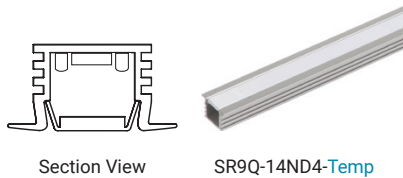

Section View

SR9Q-14ND4-Temp

Single Color Tape Light or Linear Fixture illuminaLED Vivid Series page 110

- Single Color, high light output
- 36 diodes per foot
- Available as tape lighting, tape lighting with profile (unassembled), or as assembled linear fixtures

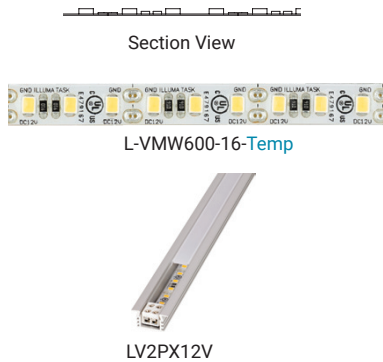

Section View

L-VMW600-16-Temp

LV2PX12V

Tunable White Tape Light or Linear Fixture TandemLED Series page 80

- Tunable White, high light output
- 88 diodes per foot
- Available as tape lighting, tape lighting with profile (unassembled), or as assembled linear fixtures

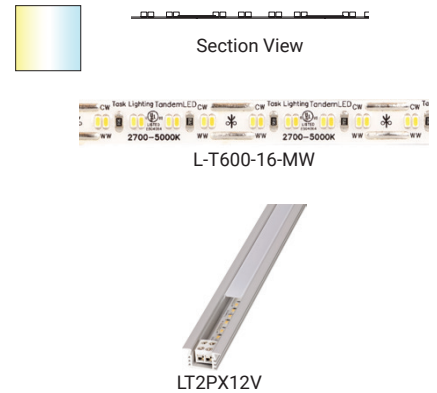

Section View

L-T600-16-MW

LT2PX12V

120V Bar Light page 188

- Higher light output
- Premium fixture for under cabinet
- Mount at the back of the cabinet

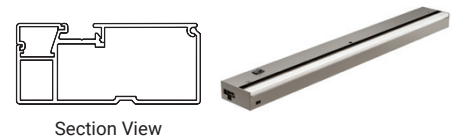

Section View

Selecting Lighting

Face frame interior cabinet – glass shelves

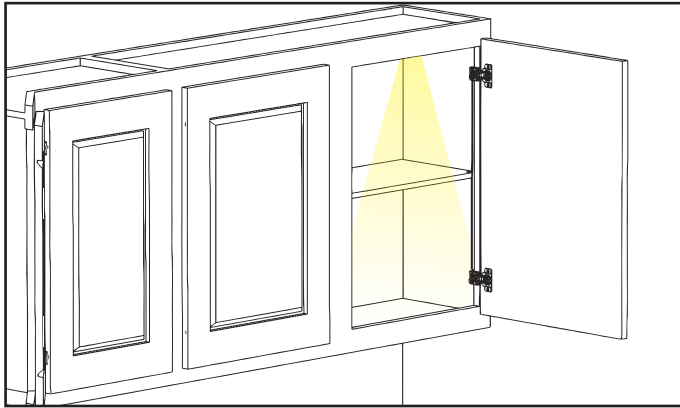

Mount in middle or front of cabinet

Puck lights provide a dramatic focus of lighting through the interior of a cabinet and can be surface mounted or recessed into the ceiling of the cabinet.

Install strip light fixtures or tape lighting horizontally at the top of the cabinet for a wash of light or vertically behind the face frame for more even lighting throughout.

NOTE: The products listed are the top recommendations for this application. Call Design Services at 866-848-9094 for additional product recommendations.

Angled Linear Fixture sempriaLED S Series page 66

- Medium, high, and higher light output available
- Mount horizontally or vertically toward the front of the inside of cabinet

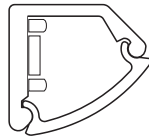

Section View



SS9E-18ND6-FTemp

Mini Angled Linear Fixture sempriaLED A Series page 64

- Medium and high light output available
- Mini profile, easy to hide fixture
- Mount horizontally or vertically toward the front of the inside of cabinet



Section View



SA9Q-12ND4-F30

Tunable White Tape Light or Linear Fixture TandemLED Series page 80

- Tunable White, high light output
- 88 diodes per foot
- Available as tape lighting, tape lighting with profile (unassembled), or as assembled linear fixtures



L-T600-16-MW



LT2P312V

Tunable White Puck Light TandemLED Series page 86

- Tunable White, medium light output
- Includes 3 lenses: 36°, 88°, and 120°
- Surface or Recess Mount

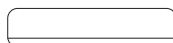

Section View



L-PS-TDC-DS

Single Color Tape Light or Linear Fixture illumLED Radiance Series page 114

- Single Color, medium light output
- 18 diodes per foot
- Available as tape lighting, tape lighting with profile (unassembled), or as assembled linear fixtures

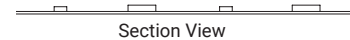

Section View



L-RMW300-16-Temp



LR1P312V

Single Color Puck Light illumLED Pearl Series page 134

- Single color white light output
- Includes 2 lenses: diamond (36°) and frosted (120°)
- Surface or Recess Mount



Section View



L-PS-FR-3BK-Temp

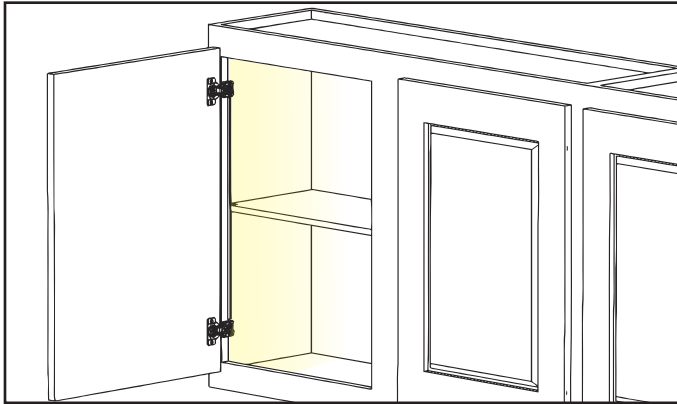

Mount vertically between hinges

For cabinets with wood shelves, mount fixtures vertically behind the face frame for even lighting top to bottom throughout the cabinet. Alternatively, install strip light fixtures or tape lighting horizontally at the ceiling and under each shelf in the cabinet.

NOTE: The products listed are the top recommendations for this application. Call Design Services at 866-848-9094 for additional product recommendations.

Angled Linear Fixture sempriaLED S Series page 66

- Medium, high, and higher light output available
- Mount horizontally or vertically toward the front of the inside of cabinet

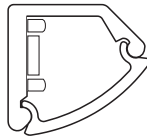

Section View



SS9E-18ND6-FTemp

Tunable White Tape Light or Linear Fixture TandemLED Series page 80

- Tunable White, high light output
- 88 diodes per foot
- Available as tape lighting, tape lighting with profile (unassembled), or as assembled linear fixtures



Section View



L-T600-16-MW



LT2P312V

Mini Angled Linear Fixture sempriaLED A Series page 64

- High and medium light output available
- Mini profile, easy to hide fixture
- Mount horizontally or vertically toward the front of the inside of cabinet



Section View



SA9Q-12ND4-FTemp

Single Color Tape Light or Linear Fixture illuminaLED Radiance Series page 114

- Single Color, high light output
- 18 diodes per foot
- Available as tape lighting, tape lighting with profile (unassembled), or as assembled linear fixtures



Section View



L-RMW300-16-Temp



LR1P312V

Selecting Lighting

Frameless interior

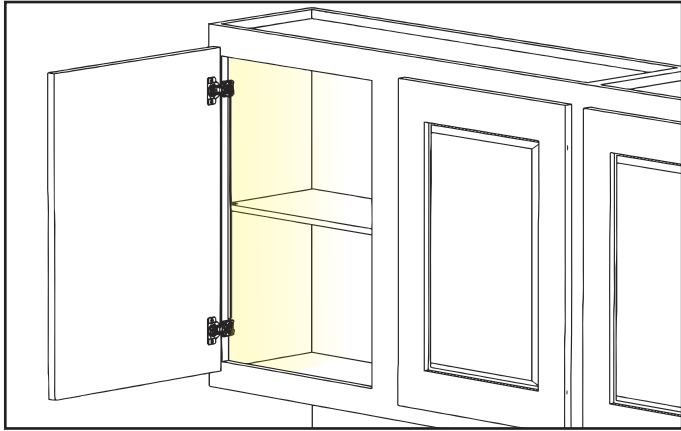

Mount vertically between hinges

Mount tape lighting vertically along the cabinet wall, avoiding hinges and shelf pin holes. Alternatively, install strip light fixtures or tape lighting horizontally at the top of the cabinet and under any wood shelves.

For glass shelves, recess or surface mount puck lights at the top of the cabinet.

NOTE: The products listed are the top recommendations for this application. Call Design Services at 866-848-9094 for additional product recommendations.

Recessed Linear Fixture sempriaLED R Series page 68

- High or higher light output available
- Premium recessed fixture – mount at the top of the cabinet

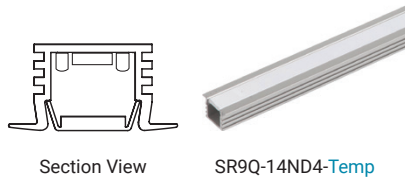

Section View

SR9Q-14ND4-Temp

Tunable White Tape Light or Linear Fixture TandemLED Series page 80

- Tunable White, high light output
- 88 diodes per foot
- Available as tape lighting, tape lighting with profile (unassembled), or as assembled linear fixtures

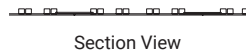

Section View



L-T600-16-MW



LT2PX12V

Single Color Tape Light or Linear Fixture illuminaLED Radiance Series page 114

- Single Color, medium light output
- 18 diodes per foot
- Available as tape lighting, tape lighting with profile (unassembled), or as assembled linear fixtures



Section View



L-RMW300-16-Temp



LR1PX12V

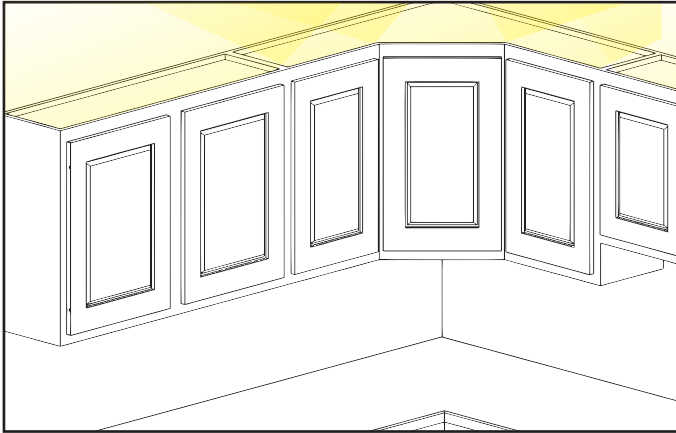

Mount at top of cabinet

Use above cabinet lighting to feature collectible displays, highlight vaulted ceilings or other architectural features, and to add depth and ambiance to a room.

NOTE: The products listed are the top recommendations for this application. Call Design Services at 866-848-9094 for additional product recommendations.

Mini Linear Fixture sempriaLED F Series page 62

- High and medium light output available
- Mini profile, easy to hide fixture
- Mount on the top at the front of the frame



Section View



SF9Q-12ND4-FTemp

Tunable White Tape Light or Linear Fixture TandemLED Series page 80

- Tunable White, high light output
- 88 diodes per foot
- Available as tape lighting, tape lighting with profile (unassembled), or as assembled linear fixtures

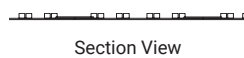

Section View



L-T600-16-MW



LT2P712V

Single Color Tape Light or Linear Fixture illumaled Radiance Series page 114

- Single Color, medium light output
- 18 diodes per foot
- Available as tape lighting, tape lighting with profile (unassembled), or as assembled linear fixtures

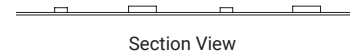

Section View



L-RMW300-16-Temp



LR1P712V

Multi-Color Tape Light illumaled Multi-Color RGB Series page 152

- Multi-Color, medium light output
- 18 diodes per foot
- Available as tape lighting or tape lighting with profile



RGB



Section View



L-RGB300-16

Selecting Lighting

Cove

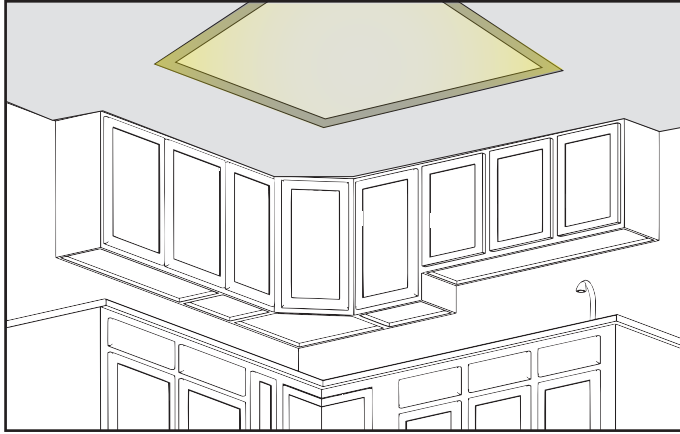

Light mounts inside the cove molding

Mount tape lighting or strip lighting fixtures inside cove molding to add ambiance to a room, from subtle to dramatic. Create a warm and cozy look for romantic evening settings.

NOTE: The products listed are the top recommendations for this application. Call Design Services at 866-848-9094 for additional product recommendations.

Mini Linear Fixture sempriaLED F Series page 62

- High and medium light output available
- Mini profile, easy to hide fixture
- Mount on the top at the front of the frame



Section View



SF9Q-12ND4-FTemp

Single Color Tape Light or Linear Fixture illumLED Radiance Series page 114

- Single Color, medium light output
- 18 diodes per foot
- Available as tape lighting, tape lighting with profile (unassembled), or as assembled linear fixtures



Section View



L-RMW300-16-Temp



LR1P712V

Tunable White Tape Light or Linear Fixture TandemLED Series page 80

- Tunable White, high light output
- 88 diodes per foot
- Available as tape lighting, tape lighting with profile (unassembled), or as assembled linear fixtures



Section View



L-T600-16-MW



LT2P712V

Multi-Color Tape Light illumLED Multi-Color RGB Series page 152

- Multi-Color, medium light output
- 18 diodes per foot
- Available as tape lighting or tape lighting with profile



Section View



L-RGB300-16

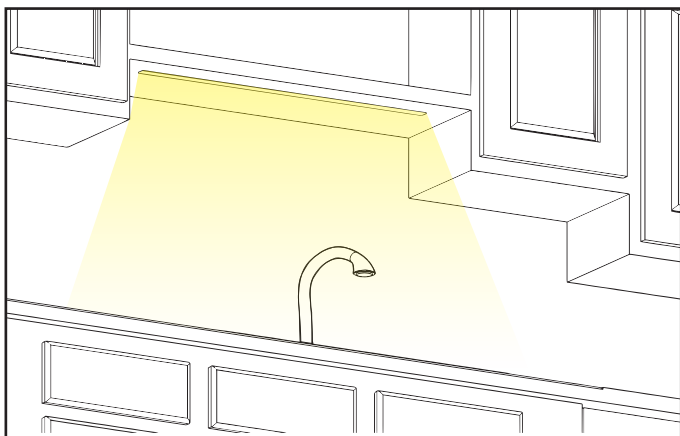

Light mounts at front of flyover

Use a light fixture over your sink to illuminate the work area and reduce eye strain.

Puck lights and Strip Light Fixtures can be surface-mounted or recessed and completely hidden.

If there is already 120V power above the sink, such as when replacing a fluorescent light, the 120V bar light is a direct replacement.

NOTE: The products listed are the top recommendations for this application. Call Design Services at 866-848-9094 for additional product recommendations.

Angled Linear Fixture sempriaLED S Series page 66

- Medium, high, and higher light output available
- Mount horizontally or vertically toward the front of the inside of cabinet

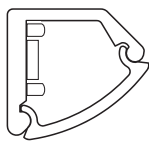

Section View



SS9E-18ND6-FTemp

Tunable White Tape Light or Linear Fixture TandemLED Series page 80

- Tunable White, high light output
- 88 diodes per foot
- Available as tape lighting, tape lighting with profile (unassembled), or as assembled linear fixtures



Section View



L-T600-16-MW



LT2P312V

Tunable White Puck Light TandemLED Series page 86

- Tunable White light output
- Includes 3 lenses: 36°, 88°, and 120°
- Surface or Recess Mount



Section View

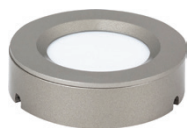

L-PS-TDC-DS

120V Bar Light page 188

- Higher light output
- Premium fixture for over sink
- Mount at the back of the flyover

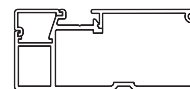

Section View



Single Color Tape Light or Linear Fixture illumaled Vivid Series page 110

- Single Color, high light output
- 36 diodes per foot
- Available as tape lighting, tape lighting with profile (unassembled), or as assembled linear fixtures

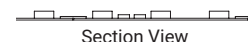

Section View



L-VMW600-16-Temp



LV2P312V

Single Color Puck Light illumaled Pearl Series page 134

- Single color white light output
- Includes 2 lenses: diamond (36°) and frosted (120°)
- Surface or Recess Mount



Section View



L-PS-FR-3BK-Temp

Selecting Lighting

Drawer

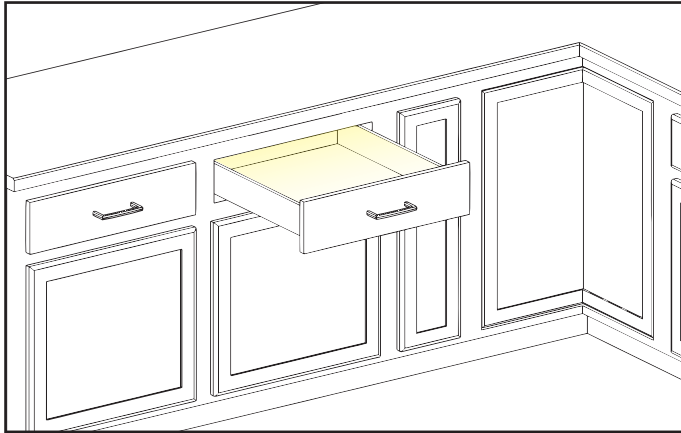

Mount lighting at front of cabinet above drawer

Use lighting inside a drawer to brighten back corners where items get lost. Use with a proximity sensor for immediate illumination when the drawer is opened.

NOTE: The products listed are the top recommendations for this application. Call Design Services at 866-848-9094 for additional product recommendations.

Single Color Tape Light illumLED Side View Series page 120

- Single Color, medium light output
- 18 diodes per foot
- Mount in the drawer behind the face frame

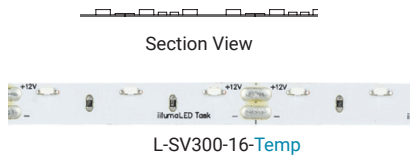

Mini Angled Linear Fixture sempriaLED A Series page 64

- High and medium light output available
- Mini profile, easy to hide fixture
- Mount horizontally or vertically toward the front of the inside of cabinet



Section View



SA9Q-12ND4-FTemp

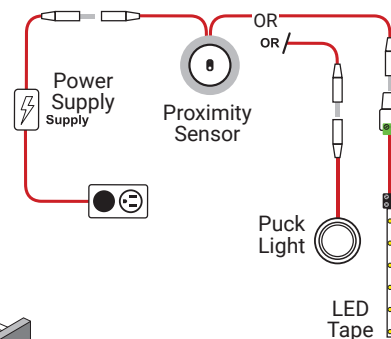
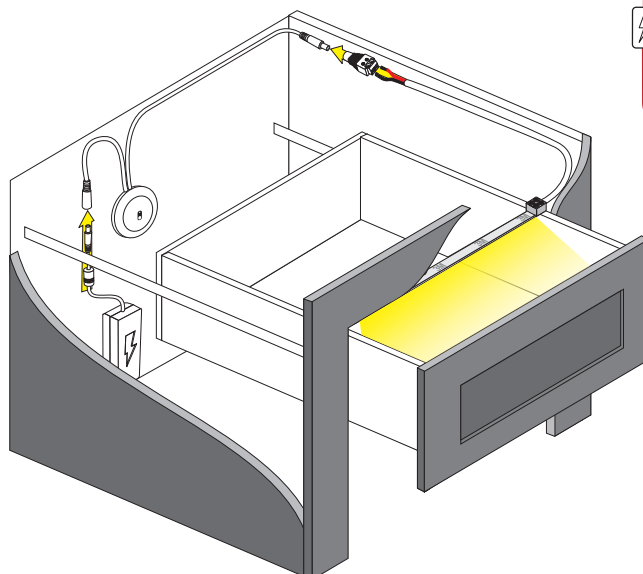

Example using T-PSS-60W-IR Proximity Switch

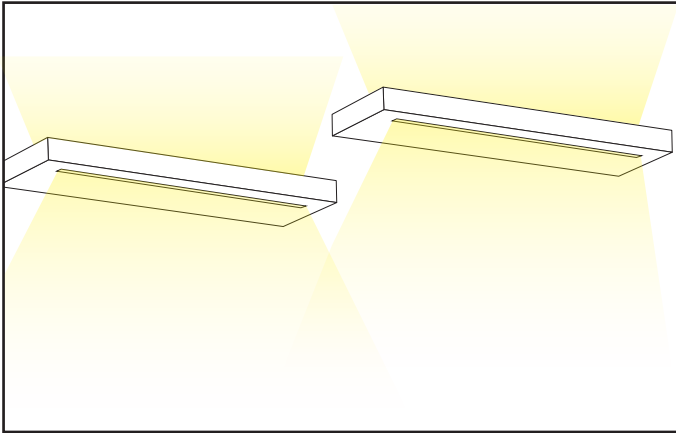

Recess toward front of shelf

Recessed lighting, under and over floating shelves, highlights collectibles and adds an elegant touch to any room.

For a brilliant presentation, recess a puck into top side of shelf and place a glass sculpture, vase, or other artwork over it to shine light directly through the glass.

NOTE: The products listed are the top recommendations for this application. Call Design Services at 866-848-9094 for additional product recommendations.

Recessed Linear Fixture sempriaLED R Series page 68

- Medium, high, and higher light output available
- Recess into the top or bottom of shelf

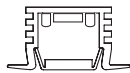

Section View



SR9Q-8ND2-FTemp

Tunable White Tape Light or Linear Fixture TandemLED Series page 80

- Tunable White, high light output
- 88 diodes per foot
- Available as tape lighting, tape lighting with profile (unassembled), or as assembled linear fixtures



Section View



L-T600-16-MW



LT2PX12V

Single Color Puck Light illumLED Pearl Series page 134

- Single color white light output
- Includes 2 lenses: diamond (36°) and frosted (120°)
- Surface or Recess Mount



Section View



L-PS-FR-3BK-Temp

Multi-Color Tape Light illumLED Multi-Color RGB Series page 152

- Multi-Color, high light output
- 18 diodes per foot
- Available as tape lighting or tape lighting with profile



RGB



Section View



L-RGB300-16

Selecting Lighting

Toe kick

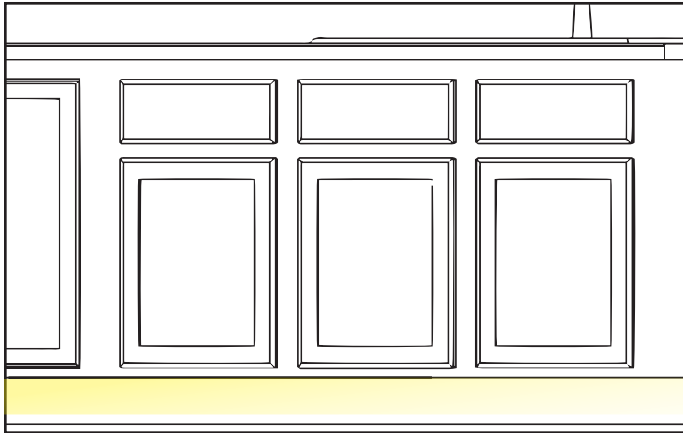

Mount at back of toe kick

Add low-level lighting to the toe kick in a kitchen or bathroom for a soft glow at nighttime, or to provide dramatic accent lighting in a design.

NOTE: The products listed are the top recommendations for this application. Call Design Services at 866-848-9094 for additional product recommendations.

Angled Linear Fixture sempriaLED S Series page 66

- Medium, high, and higher light output available
- Mount at the front of the cabinet with light focused toward the back wall

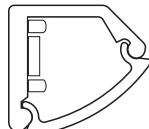

Section View



SS9E-18ND6-FTemp

Mini Angled Linear Fixture sempriaLED A Series page 64

- High and medium light output available
- Mini profile, easy to hide fixture
- Mount at the front of the cabinet with light focused toward the back wall



Section View



SA9Q-12ND4-FTemp

Single Color Tape Light or Linear Fixture illumLED Radiance Series page 114

- Single Color, medium light output
- 18 diodes per foot
- Available as tape lighting, tape lighting with profile (unassembled), or as assembled linear fixtures



Section View



L-RMW300-16-Temp



LR1P312V

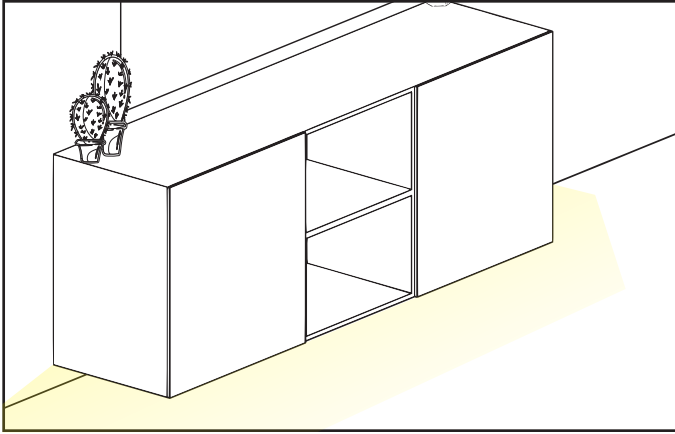

Light mounts at front of cabinet

Add low-level lighting under floating cabinets for a soft, sophisticated glow, perfect for a spa-like feel in the bathroom, or a nighttime safety feature when used with a motion sensor.

NOTE: The products listed are the top recommendations for this application. Call Design Services at 866-848-9094 for additional product recommendations.

Angled Linear Fixture sempriaLED S Series page 66

- Medium, high, and higher light output available
- Mount at the front of the cabinet with light focused toward the back wall



Single Color Tape Light or Linear Fixture illuminaLED Radiance Series page 114

- Single Color, medium light output
- 18 diodes per foot
- Available as tape lighting, tape lighting with profile (unassembled), or as assembled linear fixtures

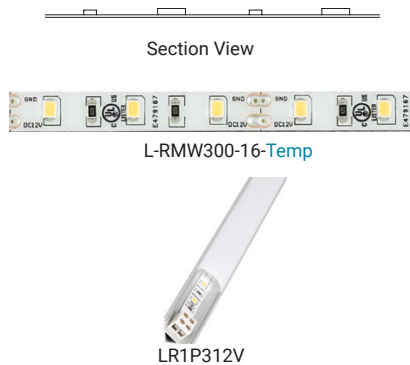

Mini Angled Linear Fixture sempriaLED A Series page 64

- High and medium light output available
- Mini profile, easy to hide fixture
- Mount at the front of the cabinet with light focused toward the back wall



Selecting Lighting

Stair steps

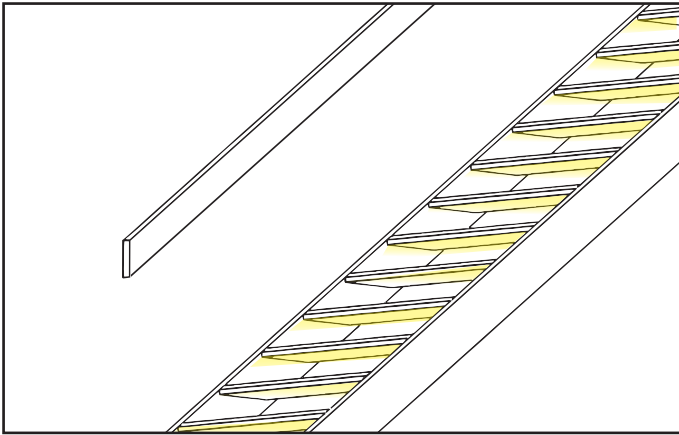

Lighting mounts at front of step

Tuck lighting directly under or behind the overhang trim of a stair tread for increased safety at night.

Add sensor switches for hands-free convenience.

NOTE: The products listed are the top recommendations for this application. Call Design Services at 866-848-9094 for additional product recommendations.

Angled Linear Fixture sempriaLED S Series page 66

- Medium, high, and higher light output available
- Mount under nosing

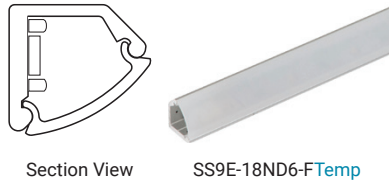

Section View

SS9E-18ND6-FTemp

Single Color Tape Light or Linear Fixture illumLED Radiance Series page 114

- Single Color, medium light output
- 18 diodes per foot
- Available as tape lighting, tape lighting with profile (unassembled), or as assembled linear fixtures

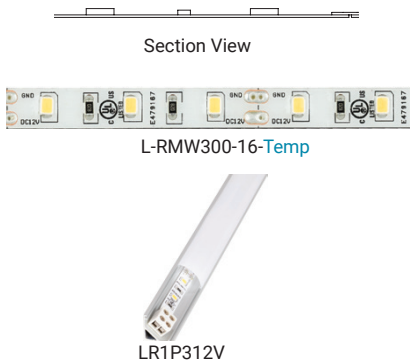

Section View

L-RMW300-16-Temp

LR1P312V

Mini Angled Linear Fixtures sempriaLED A Series page 64

- High and medium light output available
- Mini profile, easy to hide fixture
- Mount at back of the stairs with light focused toward the front of the step



Section View

SA9Q-12ND4-FTemp

Single Color Tape Light illumLED Drizzle Series page 118

- Single Color, lower light output
- 9 diodes per foot
- Available as tape lighting, or tape lighting with profile

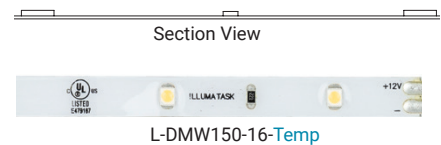

Section View

L-DMW150-16-Temp

Multi-Color Tape Light illumLED Multi-Color RGB Series page 152

- Multi-Color, high light output
- 18 diodes per foot
- Available as tape lighting or tape lighting with profile

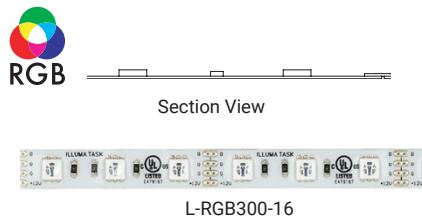

Section View

L-RGB300-16

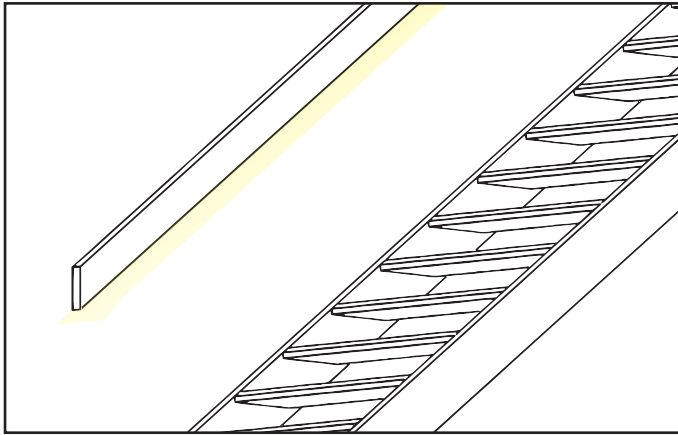

Light mounts directly beneath stair railing

Install Tape Light directly beneath a stair railing, or route a channel into the bottom of the rail and recess a strip light fixture for an inviting alternative to ceiling lighting.

Add sensor switches for a safety nightlight and hands-free convenience.

NOTE: The products listed are the top recommendations for this application. Call Design Services at 866-848-9094 for additional product recommendations.

Mini Linear Fixture sempriaLED F Series page 62

- High and medium light output available
- Mini profile, easy to hide fixture
- Install in routed channel under railing



Section View



SF9Q-12ND4-FTemp

Single Color Tape Light illumLED Drizzle Series page 118

- Single Color, lower light output
- 9 diodes per foot
- Available as tape lighting, or tape lighting with profile

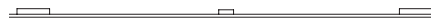

Section View



L-DMW150-16-Temp

Single Color Tape Light or Linear Fixture illumLED Radiance Series page 114

- Single Color, medium light output
- 18 diodes per foot
- Available as tape lighting, tape lighting with profile (unassembled), or as assembled linear fixtures



Section View



L-RMW300-16-Temp



LR1P712V

Multi-Color Tape Light illumLED Multi-Color RGB Series page 152

- Multi-Color, high light output
- 18 diodes per foot
- Available as tape lighting or tape lighting with profile



Section View



L-RGB300-16

Selecting Lighting

Island bar peninsula

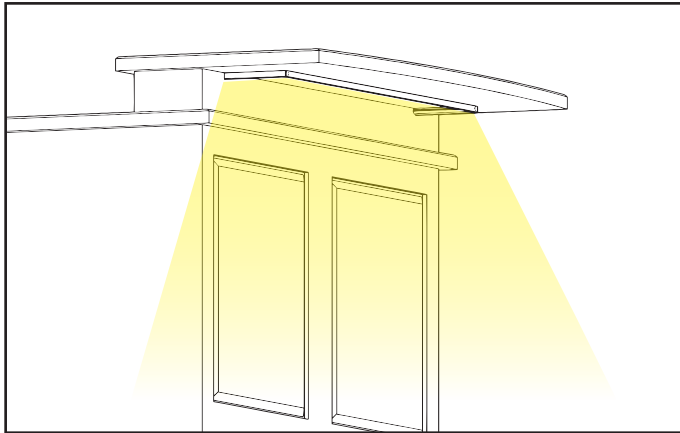

Light mounts beneath overhang

Lighting mounted underneath an island countertop or peninsula countertop brings out the inviting color and texture of the base cabinet finish and draws attention to corbels or other architectural supports.

Install beneath the overhang on a raised island countertop to provide light for the work surface.

NOTE: The products listed are the top recommendations for this application. Call Design Services at 866-848-9094 for additional product recommendations.

Mini Linear Fixture sempriaLED F Series page 62

- High and medium light output available
- Mini profile, easy to hide fixture
- Install in routed channel under raised countertop



Section View



SF9Q-12ND4-FTemp

Single Color Tape Light or Linear Fixture illuminaLED Radiance Series page 114

- Single Color, medium light output
- 18 diodes per foot
- Available as tape lighting, tape lighting with profile (unassembled), or as assembled linear fixtures



Section View



L-RMW300-16-Temp

Tunable White Tape Light or Linear Fixture TandemLED Series page 80

- Tunable White, high light output
- 88 diodes per foot
- Available as tape lighting, tape lighting with profile (unassembled), or as assembled linear fixtures



Section View



L-T600-16-MW



LT2P712V



LR1P712V

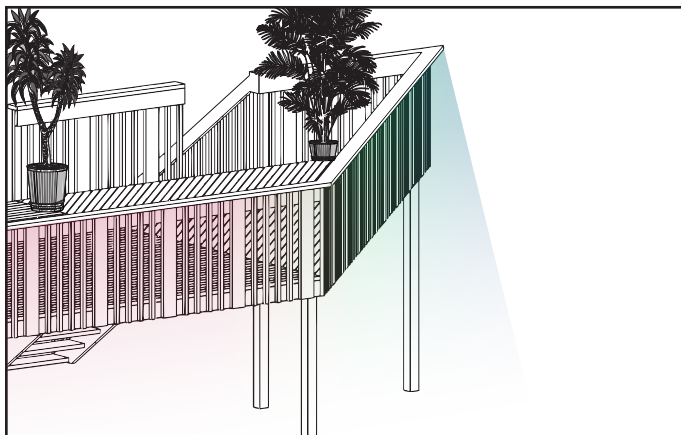

Use tape light for accent lighting outdoors

Enjoy the ambiance of your outdoor living space with lighting installed under deck rails, stair treads, and soffits. Use to enhance architectural features, such as planters and benches, or to draw attention to the texture of stone or wood fireplaces, cabinet bases, and pillars.

NOTE: The products listed are the top recommendations for this application. Call Design Services at 866-848-9094 for additional product recommendations.

Multi-Color Tape Light illumLED Multi-Color RGB Series page 152

- Multi-Color, high light output
- 18 diodes per foot
- Available as tape lighting or tape lighting with profile



L-RGB300-16

Single Color Tape Light or Linear Fixture illumLED Radiance Series page 114

- Single Color, medium light output
- 18 diodes per foot
- Available as tape lighting, tape lighting with profile (unassembled), or as assembled linear fixtures



L-RMW300-16-Temp



LR1P712V

Single Color Tape Light or Linear Fixture illumLED Vivid Series page 110

- Single Color, high light output
- 36 diodes per foot
- Available as tape lighting, tape lighting with profile (unassembled), or as assembled linear fixtures



L-VMW600-16-Temp



LV2P712V

Single Color Tape Light illumLED Drizzle Series page 118

- Single Color, lower light output
- 9 diodes per foot
- Available as tape lighting, or tape lighting with profile



L-DMW150-16-Temp