

hardware resources®

DESIGNER EDITION

Decorative Hardware • Vanities • Sinks
Kitchen, Bath, & Closet Organizers
LED Lighting & Power • Cabinetry



JEFFREY ALEXANDER®
by Hardware Resources
ELEMENTS®
by Hardware Resources

NORTH
POINT
CABINERY®

TASK™
lighting & power

2024

Hardware Resources is built around making things simple for you. The foundation of our business is supporting your efforts with best-in-class customer service teams, product innovation, and industry-leading warranties.



A LOCAL HARDWARE RESOURCES PRODUCT SPECIALIST

We have over 100 Hardware Resources sales professionals. They work and live in your community. They are experts in the products we manufacture. They know your market. They know you.

GET A LIVE PERSON ON THE PHONE, NOT A MACHINE

No one likes to talk to a machine. Call weekdays between 7:00 a.m. and 6:00 p.m. Central Time and get a friendly, live customer service representative, not a list of buttons to push.



SHOWROOM DISCOUNT PROGRAMS

Need to update your showroom? We help you invest in your showroom with special showroom pricing for Jeffrey Alexander & Elements Decorative Hardware, Jeffrey Alexander Vanities, NorthPoint Cabinetry, Task Lighting & Power, and Organizers. Ask your Hardware Resources sales professional how to order.

FREE SAMPLE PROGRAM FOR KNOBS AND PULLS

Sometimes your customer wants a sample to take home. Our Free Sample program is the answer. Ask your Hardware Resources sales professional how to order.



TOOLS THAT HELP YOU SELL MORE

Want to make it easier for your customers to select products while increasing your baseline sales? We develop tools to help with that. From printed consumer selection guide brochures to online configuration tools, we provide resources to help your be more efficient and sell more of our products. And these tools are FREE!

Huge Inventory Ready to Fill Orders

Company-owned warehouses around the US ensure fast delivery, typically in 1–3 days. 99% of orders ship within 24 hours. Custom built-to-order products typically ship in about a week.

US Manufacturing

In Bossier City, Louisiana, we manufacture and assemble custom dovetail drawer boxes, cabinet organizers, and linear mouldings. Kearney, Nebraska is home to our LED lighting and power products facility.

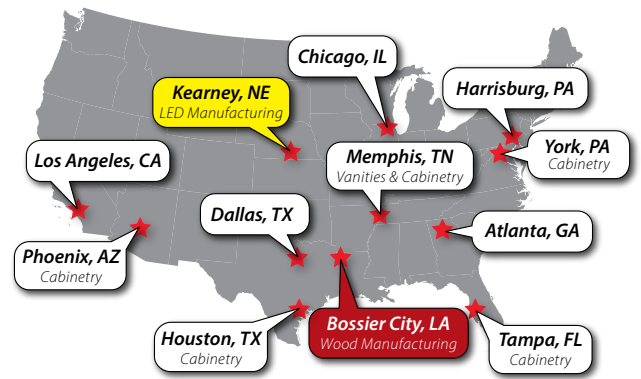

Product Development and Engineering Teams

We have a dedicated team of product development and engineering professionals both in the US and around the world. We design our products with innovations that matter so that our products are faster to install, easier to use, and live up to the lifetime of the cabinets.

Risk-Free Trial Order Program

Organizer and Task Lighting & Power products are available in our Trial Order Program. Ask your Hardware Resources sales professional for more information.

Wide Range of Product Lines

We have the products you need to create beautiful cabinetry-focused spaces like kitchens, baths, closets, laundry rooms, mudrooms and more.

JEFFREY ALEXANDER® by Hardware Resources

A step above...in quality, selection, and exclusive designs

- » Knobs & Pulls
- » Bath Vanities
- » Porcelain Sinks

ELEMENTS® by Hardware Resources

The essentials and more, priced right

- » Knobs & Pulls
- » Decorative Hooks
- » Bath Hardware

hardware resources®

Everything for the cabinets sold direct to our dealers for greater efficiency, faster delivery, outstanding service, and best value

- » Cabinet Organizers
- » Closet Organizers
- » Functional Cabinet Hardware
- » Decorative Wood & Linear Moulding
- » Dovetail Drawer Boxes
- » Stainless Steel Sinks

NORTH POINT CABINETS®

A wide array of quick to assemble cabinets providing value with a quality, custom look

- » Kitchen cabinets
- » Bath vanity cabinets

TASK™ lighting & power

Angle Power Strip products for tucked-away electrical outlets

- » Angle Power Strip
- » Lighted Power Strip

Professional-grade LED lighting—90+ CRI and UL Listed

- » LED Lighting Fixtures
- » LED Tape Lighting
- » LED Tape Lighting Kits
- » Puck Lighting
- » Commercial LED Products

Table of Contents

Knobs & Pulls

Jeffrey Alexander

Aberdeen.....	17
Alvar.....	18-19
Annadale.....	20-21
Anwick.....	22-23
Audrey.....	24-25
Belcastel 1.....	26-27
Bella.....	28
Bordeaux.....	29
Boswell.....	30-31
Bremen 1.....	32-33
Bremen 2.....	34-35
Cairo.....	36-37
Callie.....	38-39
Carmen.....	40-41
Chesapeake.....	42
Cordova.....	43
Delgado.....	44
Delmar.....	45
Dominique.....	46-47
Durham.....	48
Elara.....	50-51
Ella.....	52-53
Glenmore.....	49
Harlow.....	54-55
Hayworth.....	56-57
Hudson.....	58-59
Katharine.....	60-61
Key Grande.....	62-63
Key West & Key Largo.....	64-65
Lafayette.....	70
Larkin 1 & 2.....	66,68
Larkin 3 & 4 NEW COLLECTION	67,69
Lexa.....	71
Leyton.....	72-73
Loxley NEW COLLECTION	74-75
Lyon.....	76
Marie.....	78-79
Marlo.....	77
Merrick.....	80-81
Milan 1.....	82-83
Mirada.....	84-85
Philip.....	86-87
Rae.....	88
Regan.....	89
Renzo.....	90-91
Rhodes.....	92
Richard.....	94-95
Roman.....	96-97
Royce.....	93
Sonoma.....	98-99
Southerland NEW COLLECTION	100-101
Spencer.....	102-103
Sullivan.....	104-105
Sutton.....	106-107
Tahoe.....	108
Tiffany.....	110-111
Tuscany.....	109
Wheeler.....	112-113
Whitlock NEW COLLECTION	114-115
Zane.....	116-117
Appliance Handles.....	118-125

Elements

Aiden.....	130-131
Arcadia.....	132
Asher.....	133
Belfast.....	134
Brenton.....	135
Calloway.....	136
Capri.....	137
Cosgrove.....	138
Cypress.....	139
Edgefield NEW FINISH	140-141
Florence.....	142
Gatsby.....	143
Gibson NEW SIZES	144-145
Glendale.....	146
Hadly.....	148-149
Hammond.....	147
Kenner.....	150
Kingsport.....	151
Knox.....	152-153
Lindos.....	154
Madison.....	155
Merryville.....	156
Naples.....	158-161
Park.....	157
Seaver.....	162
Sedona.....	163
Slade.....	164
Somerset.....	165
Stanton.....	166-167
Strickland.....	168
Syracuse.....	169
Thatcher.....	170-171
Torino.....	172
Verona.....	173
Vienna.....	174
Walker 1 & 2.....	176-177
Watervale.....	175
Westbury.....	180
William NEW COLLECTION	178-179
Zachary.....	181

Accessories & Displays

Backplates.....	182
Latches.....	183
Finial Hinges.....	183
Drilling Jigs & Templates.....	184-185
Display Towers & Boards.....	186-205

Resources

Item Number Index.....	206-207
Trending Finishes Index.....	208-209
Product Resources.....	210
Finish Key.....	211
Care & Cleaning/Warranty.....	212

Bath Hardware

Elements

Bridgeport (BHE1).....	214
Fairview (BHE5).....	215
Newbury (BHE3).....	216
Curved Shower Rods.....	217
Safety Grab Bars.....	218

Decorative Hooks

Elements

YD50-518.....	220
YD45-431.....	220
YD60-550.....	220
YD55-587.....	220
YT40C-400.....	220
YT40-400.....	220
YD40-450.....	220
YD40-337.....	220
YD30-381.....	221
YD25-256.....	221
YD20-156.....	221
YD10-231.....	221
YD15-187.....	221
YS05-175.....	221
YD35-556.....	221

Vanities

Vanities

Ordering.....	225
Vanity Index.....	226-227
Premium Features & Part Number Key.....	228-229
Warranty.....	229
Collections	
Gardner COMING EARLY 2024	230-233
Tempest COMING EARLY 2024	234-237
Cade.....	238-241
Chatham.....	242-245
Dashwood NEW COLLECTION	246-249
Jubilee NEW COLLECTION	250-253
Katara.....	254-257
Kipling COMING EARLY 2024	258-259
Pascal NEW COLLECTION	260-263
Percival.....	264-265
Theodora.....	266-269
Wavecrest.....	270-273
Astoria RETIRED	274-275
Savino RETIRED	276-277
Vanity Night Light Kit.....	279
Top & Bowl Information	
Vanity Top Overview.....	280
Bowls.....	280
Vanity Top Materials NEW MATERIALS	281-283
Mirrors NEW MIRRORS & FINISHES	284-286
Resources.....	287
Finish Key.....	288

Table of Contents

Cabinet Organizers

Waste Container Organization

- NEW** Wood Bottom-Mount Trash Can Pullout with Door Kit 318–319
- NEW** Wood Bottom-Mount Trash Can Pullout for Hinged Doors 321
- Metal Drawer Box Trash Can Pullout 322
- Storage with Style® Trash Can Pullout 323
- Wood Top Mount with Soft-close 324–325
- Economy Soft-close Trash Can Pullout 326
- Wire Bottom Mount 327
- Cans & Lids 328

Base Cabinet Organization

- "No Wiggle" Base Pullout 333–334
- "No Wiggle" Knife Block Pullout 335
- "No Wiggle" Utensil Pullout 336
- "No Wiggle" Drawer Base Pullout 337
- "No Wiggle" Tray Divider Pullout 338
- "No Wiggle" Base Filler Pullouts 339
- Peg Board Filler Pullout 340
- Appliance Lift 341
- NEW** Double-Drawer Bottle Rollout 343
- NEW** Single and Double-Drawer Cookware Rollouts 344–345
- Easy-to-Install Rollout Drawers 346
- NEW** Under-Sink Silicone Mat 347

Corner Organization

- Blind Corner Swingout 350–351
- Blind Corner Sliding Door 352–353
- Easy 360 Susan 354–355
- Storage with Style® Blind Corner Pullout 356–357
- Premium Wood Lazy Susan Kits 358–359
- Premium Wood Lazy Susan Shelves & Poles 360–361
- Premium Wood Swivel Lazy Susan 362
- Economy Wire Swivel Lazy Susan 363
- Economy Banded Swivel Lazy Susan 364
- Economy Banded Lazy Susan Kits 365
- Plastic Lazy Susan with Chrome Hub Kits 366
- Economy Plastic Lazy Susan Kits 367
- Plastic Pie-cut Lazy Susan 368
- Half-moon Lazy Susan 369

Pantry Organization

- Premium Chrome Swingout 374–375
- Premium Chrome Pullout 376
- Wood Pullout 377
- Wood Swingout 378
- Wood Door Mount 379
- Build Your Own Rollouts 380
- Quick Tray Pilaster System 381
- Dovetail Drawer Boxes & Linear Material 382–383
- Slide Mounting Kit for Ball Bearing Slides 384
- Rear Mounting Block for Undermount Slides 385

Drawer Organization

- Double Cutlery Drawer 388
- Angled Utensil Insert 389
- Cutlery Insert 390
- NEW** SlimLine Cutlery Insert 391
- Knife Block Insert 392
- Spice Tray Insert 393
- NEW** Double Coffee Drawer 394
- NEW** Adjustable Drop-In Coffee Pod Insert 395
- Peg Board Insert 396
- Peg Board Accessories 397
- Tipout Tray & Kits – Stainless Steel 398
- Tipout Tray & Kits – White 399

Wall Cabinet Organization

- "No Wiggle" Wall Pullout 402
- Wall Filler Pullout 403

- Wire Tray Divider 404
- Wooden Tray Divider 405
- Door Mounted Spice Racks 406
- Wooden Stemware Rack 407
- Wooden Wine Bottle Lattice 408
- Wooden Bottle Rack & Wire Stemware 409

Storage with Style®

- Blind Corner Pullout 412–413
- Base Pullout 414
- Drawer Base Pullout 415
- Utensil Base Pullout 416
- Pot & Lid Organizer Pullout 417
- Trash Can Pullout 418
- Pullout Basket & Pilaster System 419

Easy to Install Organizers

- Pullout Baskets 421
- Trash Can Pullouts 422
- Trash Cans & Lids 423
- Cleaning Supply Caddy 424
- Pullout Pot & Lid Organizers 425
- Door Mounted Tray System 426
- Single Shelf Lazy Susan 427
- 3-Tier Spice Pulldown 428
- Sink Front Tipout Trays 429
- Under Cabinet Stemware Rack 430
- Under Cabinet Bottle Rack 430
- U-Shaped Tray Divider 431
- 3-Tier Dishcloth Rack 431
- Over the Door Towel Bar 431

Bathroom Organization

- Powered Vanity Drawer 436–437
- "No Wiggle" Vanity Pullout 438–439
- NEW** Wood Bottom-Mount Soft-Close Vanity Trash Can Pullout 440
- NEW** SlimLine Vanity Drawer Inserts 441
- Wire Cleaning Supply Caddy 442
- Wire Basket Rollout 443
- Easy-to-Install Rollout Drawers 444

NorthPoint Cabinetry® Cross Reference Guide

- 445–451

Closet Organizers

- Shoe Fence 456
- Pullout Baskets 457–459
- Pullout Nylon Hamper 460
- Pullout Plastic Hamper 461
- Pullout Pant Rack 462
- 14" Belt Rack 463
- 14" Tie Rack 463
- Tri-Level Tie Organizer 464
- Cascading Tie Organizer 465
- 12" Sliding Belt & Tie Racks 466
- Valet Rod 466
- Screw-Mount Racks 467
- Telescoping Valet Rod 468
- Laundry Valet 469
- Wardrobe Lifts 470–471
- Jewelry Trays 472
- Hooks 473
- Oval Closet Rods 474–475
- Round Closet Rods 476–479
- Task Lighting & Power Products for Closets 480–483
- Custom Dovetail Drawer Boxes for Closets 484–485
- Shelf Supports 486–490
- Heavy-duty Shelf Utility Bracket 491

Sinks

Stainless Steel Sinks

- Apron-Front/Farmhouse 290
- Premium Handmade 291
- Premium 292
- Economy 292
- Accessories (Strainer) 292
- Utility & Bar 293

Porcelain Vanity Sinks

- Oval Vanity Sinks 295
- Rectangular Vanity Sinks 295
- Specifications 296–299
- Care & Cleaning 300
- Warranty 300

Task Lighting & Power

- About Task Lighting & Power 494
- Design Services 496
- Resources for Lighting and Power 500

Power Products

- Lighted Power Strip Fixtures 506
- Lighted Power Strip (Tunable-White RM Series) 508
- Lighted Power Strip (RM Series) 510
- Lighted Power Strip (DV Series) 512

Angle Power Strip Fixtures

- Angle Power Strip (APT Series) 516
- Angle Power Strip (TR Series) 517
- Angle Power Strip (TR-USB Series) 518
- Angle Power Strip (TRS Series) 519

LED Lighting Products

- LED Tape Lighting 524
- LED Linear Fixtures 532
- LED Cut-to-Length Program 554
- LED Tape Lighting Kits 560
- Specialty Lighting 574

- LED Lighting Accessories 586
- Samples and Display Rebate 598
- Trial Order and Warranty 599



See page 601

Digital Resources

Vast video libraries on Vimeo and YouTube

Need help installing an item? We probably have a video for that!

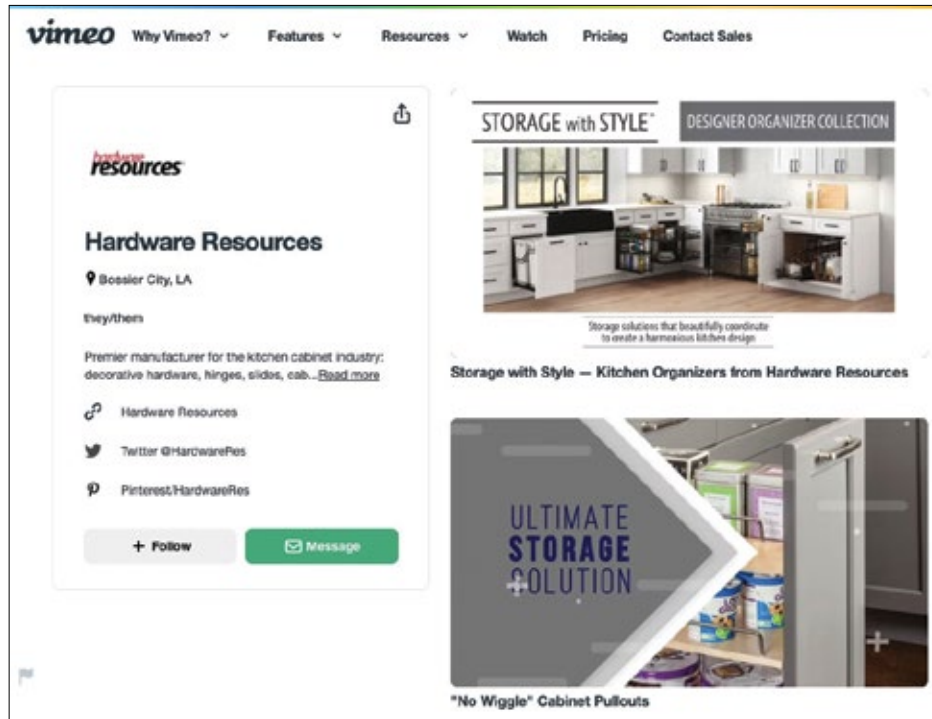

www.vimeo.com/HardwareResources

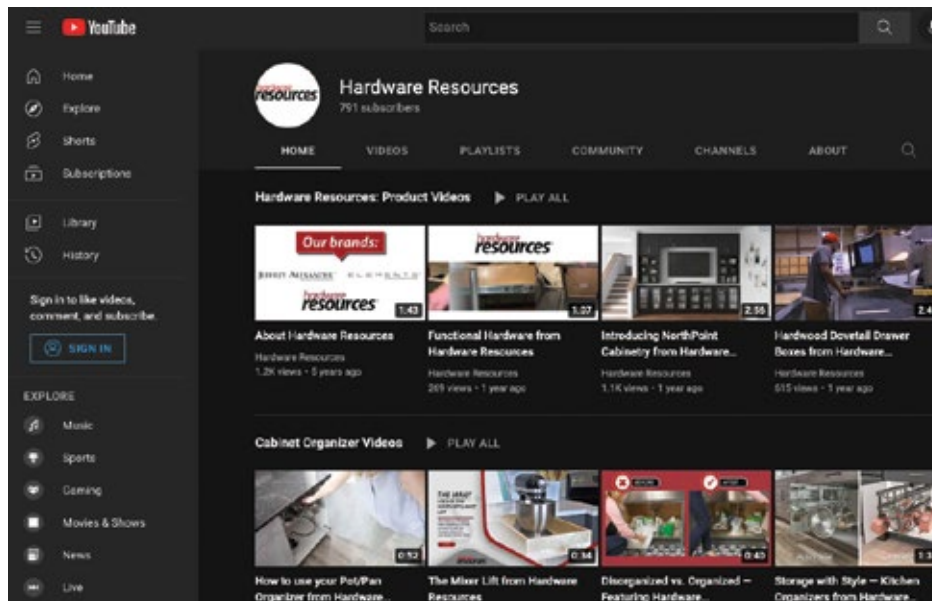

www.youtube.com/c/HardwareResources

Digital Resources

Dedicated company blog full of inspiration

Find tips and tricks of the trade plus on-trend posts that will inspire your next project.

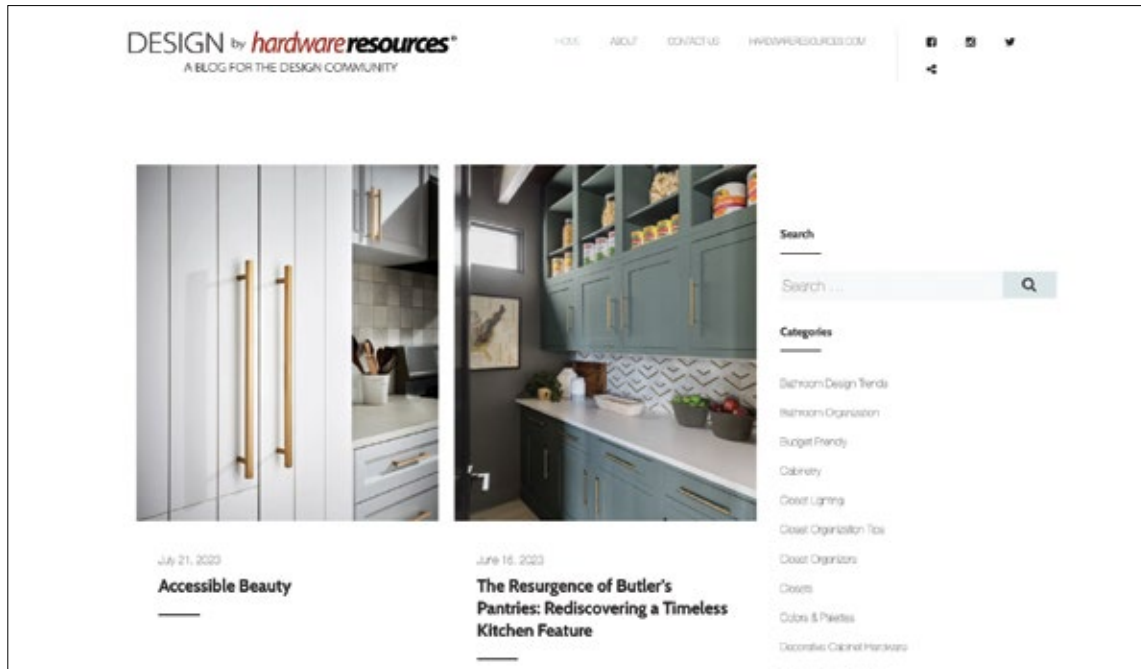

DESIGN by **hardwareresources**[®]
A BLOG FOR THE DESIGN COMMUNITY

[www. !\[\]\(83f22ed94ec5517769dd76d702c6bfd8_img.jpg\) Blog.HardwareResources.com](http://www.Blog.HardwareResources.com)

Follow us on social media!

Hardware Resources is on your favorite social media channels.



@HardwareResources
@JeffreyAlexanderBrands
@NorthPointCabinetry
@TaskLightingCorp



@Hardware_Resources
@JeffreyAlexanderBrands
@NorthPointCabinetry
@TaskLighting



@Hardware_Resources
@NorthPointCabinetry
@TaskLighting



linkedin.com/company/
HardwareResources

linkedin.com/company/
Task-Lighting-Corporation

linkedin.com/company/
NorthPoint-Cabinetry

hardware
resources[®]

800.463.0660 | www.HardwareResources.com

[5]

Web Tools—Easy online ordering, quoting, and access to resources all in one spot

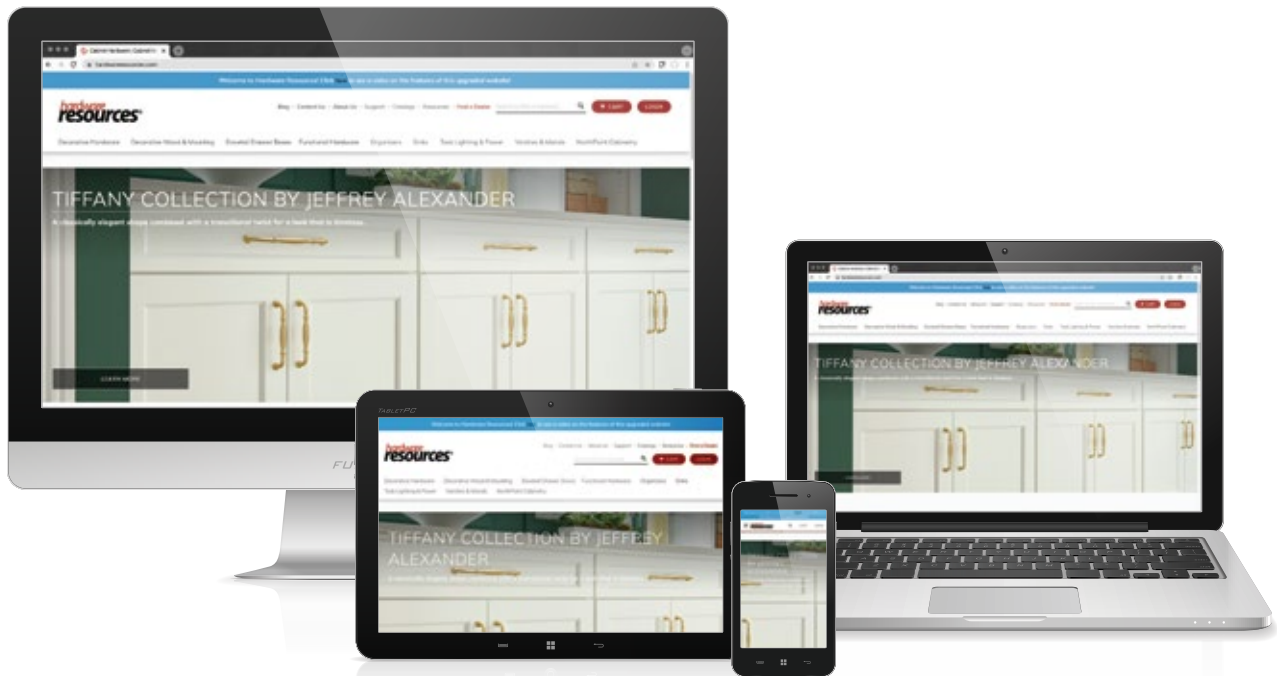

www.HardwareResources.com

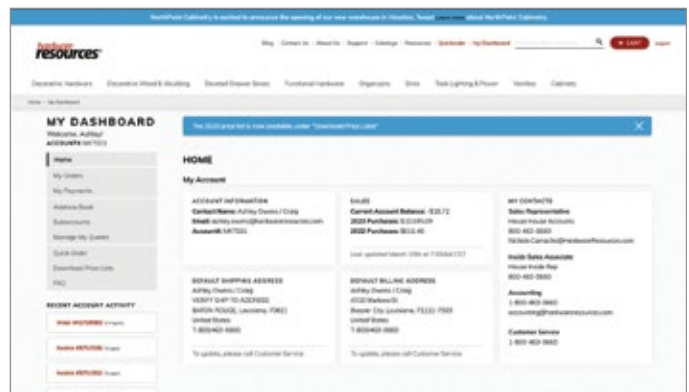
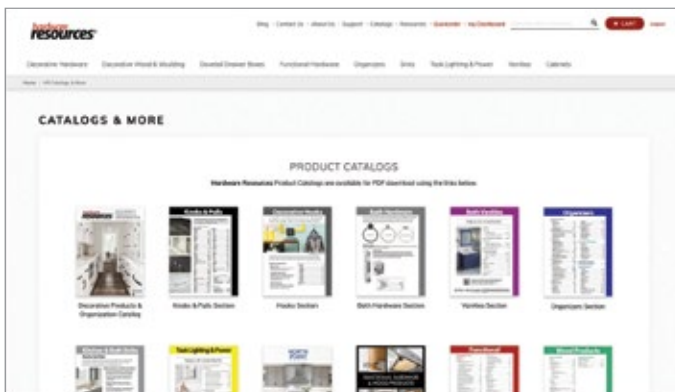

Use resources to your advantage

Use the links for **Catalogs** and **Resources** in the top menu of the website to see all the resources available to you.

Dealer dashboard account activity

Easily follow your orders, shipments, invoices, and payments in one easy-to-read layout.

Track your orders

Stay on top of your recent orders with updated status.

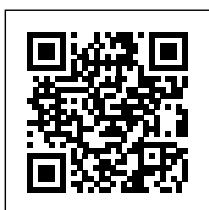

What this video to learn how to use our Quick Order feature!

Scan the QR code or visit <https://delivr.com/2gyee>

Knobs & Pulls

The finishing touch designed to make a statement

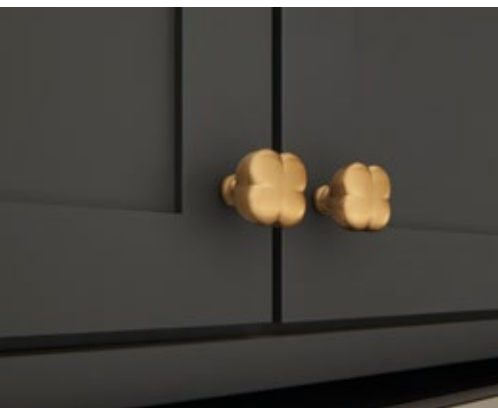

Knob & Pull Collections

Jeffrey Alexander

Aberdeen	17
Alvar	18-19
Annadale	20-21
Anwick	22-23
Audrey	24-25
Belcastel 1	26-27
Bella	28
Bordeaux	29
Boswell	30-31
Bremen 1	32-33
Bremen 2	34-35
Cairo	36-37
Callie	38-39
Carmen	40-41
Chesapeake	42
Cordova	43
Delgado	44
Delmar	45
Dominique	46-47
Durham	48
Elara	50-51
Ella	52-53
Glenmore	49
Harlow	54-55
Hayworth	56-57
Hudson	58-59
Katharine	60-61
Key Grande	62-63
Key West & Key Largo	64-65
Lafayette	70
Larkin 1 & 2	66,68
Larkin 3 & 4 NEW COLLECTION	67,69
Lexa	71
Leyton	72-73
Loxley NEW COLLECTION	74-75
Lyon	76
Marie	78-79
Marlo	77
Merrick	80-81
Milan 1	82-83
Mirada	84-85
Philip	86-87
Rae	88
Regan	89
Renzo	90-91
Rhodes	92
Richard	94-95
Roman	96-97
Royce	93
Sonoma	98-99
Southerland NEW COLLECTION	100-101
Spencer	102-103
Sullivan	104-105
Sutton	106-107
Tahoe	108
Tiffany	110-111
Tuscany	109
Wheeler	112-113
Whitlock NEW COLLECTION	114-115
Zane	116-117
Appliance Handles	118-125

Elements

Aiden	130-131
Arcadia	132
Asher	133
Belfast	134
Brenton	135
Calloway	136
Capri	137
Cosgrove	138
Cypress	139
Edgefield NEW FINISH	140-141
Florence	142
Gatsby	143
Gibson NEW SIZES	144-145
Glendale	146
Hadly	148-149
Hammond	147
Kenner	150
Kingsport	151
Knox	152-153
Lindos	154
Madison	155
Merryville	156
Naples	158-161
Park	157
Seaver	162
Sedona	163
Slade	164
Somerset	165
Stanton	166-167
Strickland	168
Syracuse	169
Thatcher	170-171
Torino	172
Verona	173
Vienna	174
Walker 1 & 2	176-177
Watervale	175
Westbury	180
William NEW COLLECTION	178-179
Zachary	181

Accessories & Displays

Backplates	182
Latches	183
Finial Hinges	183
Drilling Jigs & Templates	184-185
Display Towers & Boards	186-205

Resources

Item Number Index	206-207
Trending Finishes Index	208-209
Product Resources	210
Finish Key	211
Care & Cleaning/Warranty	212



Larkin 3 & 4 (Knurled)

See pages 67,69

New collections



Knurled Center

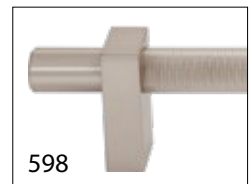

Knurled Ends

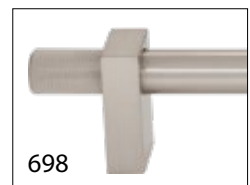



Loxley

See pages 74-75

New collection





Southerland

See pages 100-101

New collection





Whitlock

See pages 114-115

New collection





William

See pages 178-179

New collection



Edgefield

See pages 140-141

New finish

ABG - Aluminum Brushed Gold

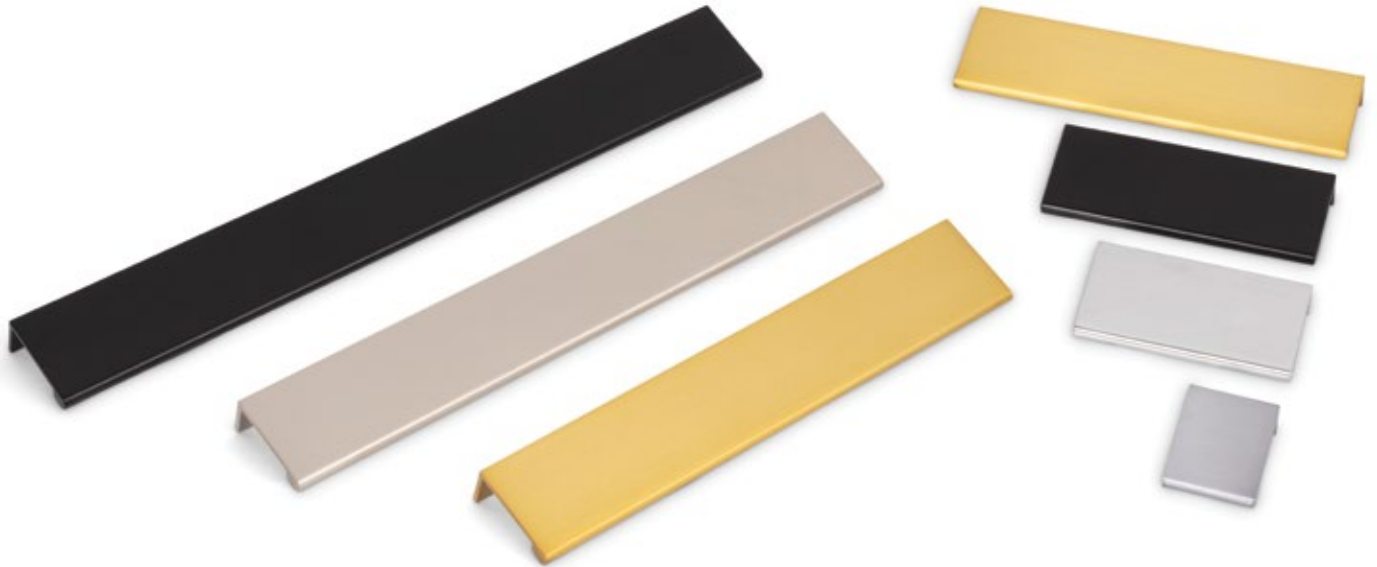

Gibson

See pages 144-145

New sizes and knob





































































224 mm, 305 mm, and 12" pulls





These products are being retired. Check availability online or call for products marked with "+"

See collection pages for finish and size options

							
Aberdeen [†] page 17	Aberdeen [†] page 17	Annadale page 20	Annadale page 20	Anwick page 22	Anwick page 22	Audrey page 24	Belcastel 1 page 26
							
Bella page 28	Bella page 28	Bordeaux page 29	Bremen 1 page 32	Bremen 2 page 34	Bremen 2 page 34	Cairo & Royce page 36 & 93	Carmen page 40
							
Carmen page 40	Chesapeake page 42	Chesapeake & Cordova pages 42 & 43	Cordova page 43	Cordova page 43	Delgado page 44	Delmar page 45	Dominique page 46
							
Dominique page 46	Durham page 48	Elara page 50	Ella page 52	Glenmore [†] page 49	Harlow page 54	Harlow page 54	Harlow page 54
							
Harlow page 54	Harlow page 54	Hayworth page 56	Hayworth page 56	Hudson page 58	Katharine page 60	Key Grande page 62	Key West & Key Largo page 64
							
Lafayette page 70	Lafayette page 70	Lafayette page 70	Larkin 1 & 2 page 68	Larkin 3 & 4 NEW page 69	Lexa page 71	Loxley NEW page 74	Loxley NEW page 74
							
Lyon page 76	Marie page 78	Marlo page 77	Milan 1 page 82	Mirada page 84	Philip page 86	Rae [†] page 88	Renzo page 90
							
Rhodes page 92	Richard page 94	Roman page 96	Sonoma & Royce page 98 & 93	Southerland NEW page 100	Spencer page 102	Sullivan page 104	Tahoe page 108
							
Tiffany page 110	Tuscan [†] page 109	Wheeler page 112	Whitlock NEW page 114	Zane page 116			

All products, unless otherwise noted, are packaged with installation screws (8-32 standard and 8-32 breakaway screws).



A step above... in Quality, Selection, and Design

Quality

All our products are manufactured from the highest quality materials and undergo meticulous examination to ensure only the best products reach your door. We believe strongly in the quality, integrity, and reliability of our products and offer a lifetime warranty on all Jeffrey Alexander decorative hardware (see page 212).

Selection

Jeffrey Alexander offers 60+ patented and original collections plus a variety of industry-standard designs in a wide range of styles and finishes. With extended lengths as well as appliance handles available in many of our collections, there's something for everyone.

Design

Inspiration comes from the latest styles in interior design to the newest fashion trends on the runway. That inspiration is creatively transformed into beautiful hardware for any kitchen, bath, or home project. Our designs are heavier in weight with solid or flat backs, not hollow backs, adding a touch of luxury while providing a comfortable feel in your hand.



536-128BNBDL



535-160SN



536-96DBAC



535-128BNBDL



535L-DBAC



535DBAC



535-96BNB



535L-BNB



535L-BNBDL



535L-SN

Knobs	Description	Overall Length	Width at Center	Projection	Hand Space	Foot Width	Foot Length	Inner Box	Price Code
535 [†]	square knob	1-1/4"	1-1/4"	1-1/4"	1"	3/4"	3/4"	20	[F]
535L [†]	rectangle knob	1-1/2"	7/8"	1-1/4"	1"	3/4"	3/4"	20	[F]

Pulls	Center-to-Center	Overall Length	Width at Center	Projection	Hand Space	Foot Width	Foot Length	Inner Box	Price Code
535-96 [†]	96 mm (3-3/4") CC	5"	7/8"	1"	13/16"	1-1/4"	1"	10	[H]
536-96 [†]	96 mm (3-3/4") CC cup pull	5"	1-1/16"	1"	7/8"	1-1/4"	5"	10	[H]
535-128 [†]	128 mm (5-1/16") CC	6-1/4"	7/8"	1-1/16"	7/8"	1-1/4"	1"	10	[J]
536-128 [†]	128 mm (5-1/16") CC cup pull	6-1/4"	1-1/16"	1-1/16"	15/16"	1-1/4"	6-1/4"	10	[K]
535-160 [†]	160 mm (6-5/16") CC	7-9/16"	7/8"	1-1/16"	7/8"	1-1/4"	1"	10	[K]

Finishes



BNB
Brushed
Black Nickel



BNBDL
Brushed Pewter



DBAC
Brushed Oil
Rubbed Bronze



SN
Satin Nickel

These products are being retired.
Check availability online or call for products marked with "†"



PATENT
D708,927; D707,098;
D722,483; D710,674



264-160SN

264-96BNBDL

264-3DBAC

264-96MB

264-128PC

264-192NI

264-192SBZ

Pulls	Center-to-Center	Overall Length	Width at Center	Projection	Hand Space	Foot Width	Foot Length	Inner Box	Price Code
264-3	3" CC	3-11/16"	3/8"	1-1/16"	13/16"	3/8"	5/8"	20	[D]
264-96	96 mm (3-3/4") CC	4-7/16"	3/8"	1-1/16"	13/16"	3/8"	5/8"	20	[E]
264-128	128 mm (5-1/16") CC	5-3/4"	3/8"	1-1/16"	13/16"	3/8"	5/8"	20	[E]
264-160	160 mm (6-5/16") CC	7"	3/8"	1-1/16"	13/16"	3/8"	5/8"	10	[F]
264-192	192 mm (7-9/16") CC	8-1/4"	3/8"	1-1/16"	13/16"	3/8"	5/8"	10	[G]

Display	Description
DB801-GRY	Alvar hardware on Designer Grey display board, 16"W x 11"H



GRACEFUL

Alvar's graceful yet straightforward and contemporary curved profile is sure to enchant. With a variety of lengths and finishes, this pull collection blends well with raised panel, flat panel, and Shaker-style cabinets.



Shown in Polished Nickel

Finishes



BNBDL
Brushed Pewter



DBAC
Brushed Oil Rubbed Bronze



MB
Matte Black



NI
Polished Nickel



PC
Polished Chrome



SBZ
Satin Bronze



SN
Satin Nickel



Knobs	Description	Overall Length	Width at Center	Projection	Hand Space	Foot Width	Foot Length	Inner Box	Price Code
435	square knob	1-1/4"	1-1/4"	1-1/4"	15/16"	3/4"	3/4"	20	[F]
435L	rectangle knob	1-1/2"	7/8"	1-1/4"	15/16"	3/4"	3/4"	20	[F]

Pulls	Center-to-Center	Overall Length	Width at Center	Projection	Hand Space	Foot Width	Foot Length	Inner Box	Price Code
435-96	96 mm (3-3/4") CC	5"	7/8"	1-1/8"	7/8"	1-1/4"	1"	10	[G]
436-96	96 mm (3-3/4") CC cup pull	5"	1-1/16"	1-1/8"	15/16"	1-1/4"	5"	10	[H]
435-128	128 mm (5-1/16") CC	6-1/4"	7/8"	1-3/16"	15/16"	1-1/4"	1"	10	[J]
436-128	128 mm (5-1/16") CC cup pull	6-1/4"	1-1/16"	1-3/16"	15/16"	1-1/4"	6-1/4"	10	[K]
435-160	160 mm (6-5/16") CC	7-9/16"	7/8"	1-3/16"	15/16"	1-1/4"	1"	10	[K]

Display	Description
DB982-GRY	Annadale hardware on Designer Grey display board, 16"W x 11"H



PATENT

D708,040; D708,926;
D721,941; D711,722



Shown in Brushed Oil Rubbed Bronze

INVITING

A wide square shape softened with a pillow top accent makes Annadale an inviting and strikingly beautiful choice. Standard pulls and cup pulls are available to add the finishing touch to Shaker cabinets.

Finishes



BNBDL
Brushed Pewter



DACM
Gun Metal



DBAC
Brushed Oil
Rubbed Bronze



MB
Matte Black



SN
Satin Nickel



Knobs	Description	Overall Length	Width at Center	Projection	Hand Space	Foot Width	Foot Length	Inner Box	Price Code
867	rectangle knob	1-3/8"	5/8"	1-1/16"	13/16"	5/8"	5/16"	30	[E]
867L	square knob	1-1/8"	1-1/8"	1-1/16"	13/16"	1-1/8"	5/16"	20	[E]

Pulls	Center-to-Center	Overall Length	Width at Center	Projection	Hand Space	Foot Width	Foot Length	Inner Box	Price Code
867-3	3" CC	4-5/16"	5/8"	1-1/16"	13/16"	5/8"	5/16"	10	[F]
867-96	96 mm (3-3/4") CC	5-1/8"	5/8"	1-1/16"	13/16"	5/8"	5/16"	10	[G]
867-128	128 mm (5-1/16") CC	6-3/8"	5/8"	1-1/16"	13/16"	5/8"	5/16"	10	[H]
867-160	160 mm (6-5/16") CC	7-5/8"	5/8"	1-1/16"	13/16"	5/8"	5/16"	10	[J]
867-228	228 mm (9") CC	10-5/16"	5/8"	1-1/16"	13/16"	5/8"	5/16"	10	[K]
867-320	320 mm (12-5/8") CC	13-15/16"	5/8"	1-1/16"	13/16"	5/8"	5/16"	10	[K]

Display	Description
DB993-GRY	Anwick hardware on Designer Grey display board, 16"W x 11"H



PATENT D728,342; D737,654



MODERN

The intricate decorative line detail and soft modern edge of Anwick create a unique and unrivaled contemporary look. Offered in extended lengths, this sleek pull design helps create a continuous clean line on wide drawers for a balanced and streamlined look.



Finishes



BNBDL
Brushed Pewter



DBAC
Brushed Oil
Rubbed Bronze



NI
Polished Nickel



SN
Satin Nickel



Knobs	Description	Overall Length	Width at Center	Projection	Hand Space	Foot Width	Foot Length	Inner Box	Price Code
278	square knob	1-1/8"	1-1/8"	1-7/16"	15/16"	1/2"	1/2"	20	[D]
278L	large square knob	1-3/8"	1-3/8"	1-7/16"	15/16"	1/2"	1/2"	10	[D]
Pulls	Center-to-Center	Overall Length	Width at Center	Projection	Hand Space	Foot Width	Foot Length	Inner Box	Price Code
278-96	96 mm (3-3/4") CC	4-1/4"	5/8"	1-1/2"	7/8"	1/2"	1/2"	10	[E]
278-128	128 mm (5-1/16") CC	5-9/16"	5/8"	1-1/2"	7/8"	1/2"	1/2"	10	[F]
278-160	160 mm (6-5/16") CC	6-13/16"	5/8"	1-1/2"	7/8"	1/2"	1/2"	10	[G]
278-192	192 mm (7-9/16") CC	8-1/16"	5/8"	1-1/2"	7/8"	1/2"	1/2"	10	[H]
278-224	224 mm (8-3/16") CC	9-3/8"	11/16"	1-9/16"	7/8"	9/16"	9/16"	10	[H]
278-305	305 mm (12") CC	12-9/16"	11/16"	1-9/16"	7/8"	9/16"	9/16"	10	[K]
278-12	12" CC app. handle	12-5/8"	1"	2-1/4"	1-1/4"	3/4"	3/4"	5	[K]
278-18*	18" CC app. handle	18-3/4"	1"	2-1/4"	1-1/4"	3/4"	3/4"	5	[K]

Display	Description
DB819-GRY	Audrey hardware on Designer Grey display board, 16"W x 11"H



*18" appliance handles are packaged with 10-24 standard and 10-24 breakaway screws.



Shown in Satin Bronze

POISED

Poised and effortlessly charming, Audrey from Jeffrey Alexander adds understated elegance to any room. With an impeccably tailored silhouette on both the cabinet knob and pull, this collection delivers a modern expression with lavish contours, sparkling with charisma and class. The sweeping curves of Audrey's cabinet pull not only provide an exceptional feel in the hand but also add a little more hand clearance for ensured comfortability.

Finishes



BG
Brushed Gold



BNBDL
Brushed Pewter



DBAC
Brushed Oil
Rubbed Bronze



MB
Matte Black



PC
Polished Chrome



SBZ
Satin Bronze



SN
Satin Nickel



Knobs	Description	Overall Length/ Diameter	Width at Center	Projection	Hand Space	Foot Width	Foot Length	Inner Box	Price Code
MO6303	round knob	1-3/8"	1-3/8"	1-1/16"	11/16"	11/16"	13/16"	20	[D]

Pulls	Center-to-Center	Overall Length	Width at Center	Projection	Hand Space	Foot Width	Foot Length	Inner Box	Price Code
MO6373	96 mm (3-3/4") CC	4-5/8"	7/16"	1-3/16"	13/16"	3/4"	7/8"	15	[E]
MO6373-128	128 mm (5-1/16") CC	5-7/8"	7/16"	1-3/16"	13/16"	3/4"	7/8"	20	[F]
MO6373-160	160 mm (6-5/16") CC	7-1/8"	7/16"	1-3/16"	13/16"	3/4"	7/8"	10	[G]
MO6373-12	12" CC appl. handle	13-1/4"	3/4"	2-5/16"	1-11/16"	1-1/8"	1-1/4"	5	[K]
MO6373-18*	18" CC appl. handle	19-1/4"	3/4"	2-5/16"	1-11/16"	1-1/8"	1-1/4"	5	[K]

Display	Description
DB971-GRY	Belcastel 1 hardware on Designer Grey display board, 16"W x 11"H

*18" appliance handles are packaged with 10-24 standard and 10-24 breakaway screws.



CLASSIC

Belcastel 1 embodies a classic and dashing personality with its soft, square foot and gentle curves. This collection is a chameleon, harmoniously melding with Shaker, traditional, or slab cabinet styles with its eleven different finishes.



Shown in Satin Nickel

Finishes



ABM-D
Distressed
Antique Brass



BNBDL
Brushed Pewter



DACM
Gun Metal



DBAC
Brushed Oil
Rubbed Bronze



DMAC
Distressed Oil
Rubbed Bronze



MB
Matte Black



NI
Polished Nickel



PC
Polished Chrome



SBZ
Satin Bronze



SIM-D
Distressed
Antique Silver



SN
Satin Nickel





Knobs	Description	Overall Length	Width at Center	Projection	Hand Space	Foot Width	Foot Length	Inner Box	Price Code
818	round knob	1-3/8"	1-3/8"	1-1/8"	3/4"	5/8"	5/8"	20	[F]
818L	T-knob	2-1/4"	11/16"	1-3/8"	3/4"	5/8"	5/8"	20	[G]

Pulls	Center-to-Center	Overall Length	Width at Center	Projection	Hand Space	Foot Width	Foot Length	Inner Box	Price Code
818-96	96 mm (3-3/4") CC	4-3/8"	5/8"	1-3/8"	13/16"	5/8"	5/8"	15	[H]
818-128	128 mm (5-1/16") CC	5-11/16"	5/8"	1-3/8"	3/4"	5/8"	5/8"	15	[H]
818-160	160 mm (6-5/16") CC	6-15/16"	5/8"	1-3/8"	3/4"	5/8"	5/8"	10	[J]
818-12	12" CC appl. handle	13-1/8"	1"	2"	1"	1-1/8"	1-1/8"	5	[K]

Display	Description
DB975-GRY	Bella hardware on Designer Grey display board, 16"W x 11"H

Finishes



D662,388; D661,972;
D660,679



ABSBS
Antique Brushed Satin Brass



BNBDL
Brushed Pewter



DBAC
Brushed Oil Rubbed Bronze



NI
Polished Nickel



SN
Satin Nickel



Knobs	Description	Overall Length	Width at Center	Projection	Hand Space	Foot Width	Foot Length	Inner Box	Price Code
3990	oval knob	1-3/16"	13/16"	1-5/16"	9/16"	9/16"	9/16"	25	[D]

Pulls	Center-to-Center	Overall Length	Width at Center	Projection	Hand Space	Foot Width	Foot Length	Inner Box	Price Code
8236	96 mm (3-3/4") CC	5"	1-5/16"	1-1/4"	1-3/16"	1-5/16"	5"	25	[E]

Display	Description
DB925-GRY	Bordeaux hardware on Designer Grey display board, 16"W x 11"H

Finishes





177-224PC

177-160BNBDL

177-96MB

177-128DBAC

177-192SN

Pulls	Center-to-Center	Overall Length	Width at Center	Projection	Hand Space	Foot Width	Foot Length	Inner Box	Price Code
177-96	96 mm (3-3/4") CC	4-1/4"	1/2"	1-1/16"	13/16"	1/2"	5/8"	15	[E]
177-128	128 mm (5-1/16") CC	5-9/16"	1/2"	1-1/16"	13/16"	1/2"	5/8"	15	[F]
177-160	160 mm (6-5/16") CC	6-13/16"	1/2"	1-1/16"	13/16"	1/2"	5/8"	10	[G]
177-192	192 mm (7-9/16") CC	8-1/16"	1/2"	1-1/16"	13/16"	1/2"	5/8"	10	[G]
177-224	224 mm (8-13/16") CC	9-5/16"	1/2"	1-1/16"	13/16"	1/2"	5/8"	10	[H]

Display	Description
DB805-GRY	Boswell hardware on Designer Grey display board, 16"W x 11"H



Shown in Matte Black

CONTEMPORARY

Boswell combines gentle lines and a gracefully angled foot putting a modern twist on the traditional square bar pull. Adding a rounded undercurve for a touch of delicacy to the overall sleek profile, this pull collection is ideally suited to today's top trending soft contemporary styles.

Finishes



BNBDL
Brushed Pewter



DBAC
Brushed Oil
Rubbed Bronze



MB
Matte Black



PC
Polished Chrome



SN
Satin Nickel



Knobs	Description	Overall Length	Width at Center	Projection	Hand Space	Foot Width	Foot Length	Inner Box	Price Code
117	round knob	1-1/4"	1-1/4"	1-1/16"	5/8"	3/4"	3/4"	20	[D]

Pulls	Center-to-Center	Overall Length	Width at Center	Projection	Hand Space	Foot Width	Foot Length	Inner Box	Price Code
527	96 mm (3-3/4") CC	4-5/8"	7/16"	1-3/16"	13/16"	7/8"	7/8"	15	[F]
527-128	128 mm (5-1/16") CC	5-7/8"	7/16"	1-1/8"	13/16"	13/16"	13/16"	10	[F]
527-160	160 mm (6-5/16") CC	7-1/8"	7/16"	1-1/8"	13/16"	13/16"	13/16"	10	[H]
527-12	12" CC appl. handle	13-1/8"	3/4"	2-1/16"	1-1/2"	1-1/8"	1-1/8"	5	[K]

Display	Description
DB974-GRY	Bremen 1 hardware on Designer Grey display board, 16"W x 11"H



EFFORTLESS

The stylish curves and simple stacked feet of Bremen 1 deliver effortless appeal and pizzazz to cabinets. Mirroring those appealing qualities in its button knob, this collection is equally at home in transitional or traditional settings.



Shown in Satin Bronze

Finishes



ABM-D
Distressed
Antique Brass



ABSB
Antique Brushed
Satin Brass



BNBDL
Brushed Pewter



DACM
Gun Metal



DBAC
Brushed Oil
Rubbed Bronze



DMAC
Distressed Oil
Rubbed Bronze



NI
Polished Nickel



PC
Polished Chrome



SBZ
Satin Bronze



SIM
Distressed
Antique Silver



SN
Satin Nickel



Knobs	Description	Overall Length	Width at Center	Projection	Hand Space	Foot Width	Foot Length	Inner Box	Price Code
127	barrel knob	1-3/16"	1-3/16"	1-1/8"	5/8"	13/16"	13/16"	20	[D]
137	stacked knob	1-1/4"	1-1/4"	1-1/8"	11/16"	3/4"	3/4"	30	[D]

Pulls	Center-to-Center	Overall Length	Width at Center	Projection	Hand Space	Foot Width	Foot Length	Inner Box	Price Code
537	96 mm (3-3/4") CC	4-3/16"	1/2"	1-1/4"	11/16"	3/8"	3/8"	20	[E]
537-128	128 mm (5-1/16") CC	5-7/16"	1/2"	1-1/4"	11/16"	3/8"	3/8"	10	[F]
537-160	160 mm (6-5/16") CC	6-11/16"	1/2"	1-1/4"	11/16"	3/8"	3/8"	10	[F]
537-12	12" CC appl. handle	12-11/16"	5/8"	1-5/8"	7/8"	11/16"	11/16"	5	[K]

Display	Description
DB973-GRY	Bremen 2 hardware on Designer Grey display board, 16"W x 11"H



Shown in Gun Metal

UNFAILING

The unfailing style of Bremen 2 is highlighted by slight curves and a sturdy presence. The stacked barrel design is echoed across three standard pull lengths, an appliance handle, and two coordinating knobs. Bremen 2 feels at home in either a traditional or American Country design.

Design Idea

Achieve a confidently understated look by pairing dark cabinet finishes with dark hardware.

Finishes



ABSB
Antique Brushed
Satin Brass



DACM
Gun Metal



DBAC
Brushed Oil
Rubbed Bronze



DMAC
Distressed Oil
Rubbed Bronze



NI
Polished Nickel



SN
Satin Nickel



Knobs	Description	Overall Length	Width at Center	Projection	Hand Space	Foot Width	Foot Length	Inner Box	Price Code
595	pyramid knob	1-1/4"	1-1/4"	7/8"	9/16"	5/8"	5/8"	20	[D]

Pulls	Center-to-Center	Overall Length	Width at Center	Projection	Hand Space	Foot Width	Foot Length	Inner Box	Price Code
595-96	96 mm (3-3/4") CC	4-13/16"	1/2"	1-1/8"	7/8"	1"	11/16"	20	[E]
595-128	128 mm (5-1/16") CC	6-1/16"	1/2"	1-1/8"	15/16"	1"	11/16"	15	[E]

Display	Description
DB981-GRY	Cairo hardware on Designer Grey display board, 16"W x 11"H





REMINISCENT

Reminiscent of the pyramids in Egypt, Cairo's dramatic faceted design meets elegant curves to create a look that echoes architectural history. The angled profile of this knob and pull combination catches the light in just the right way to add grandeur to cabinets.



Finishes

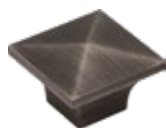

BNBDL
Brushed Pewter

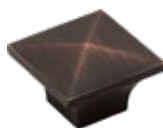

DBAC
Brushed Oil
Rubbed Bronze

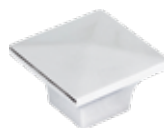

PC
Polished Chrome



SN
Satin Nickel



Pulls	Center-to-Center	Overall Length	Width at Center	Projection	Hand Space	Foot Width	Foot Length	Inner Box	Price Code
839-3	3" CC	4-3/16"	3/8"	1-1/4"	13/16"	7/16"	13/16"	20	[E]
839-96	96 mm (3-3/4") CC	4-15/16"	3/8"	1-1/4"	13/16"	7/16"	13/16"	15	[F]
839-128	128 mm (5-1/16") CC	6-1/4"	3/8"	1-1/4"	13/16"	7/16"	13/16"	15	[G]
839-160	160 mm (6-5/16") CC	7-1/2"	3/8"	1-1/4"	13/16"	7/16"	13/16"	10	[H]

Display	Description
DB998-GRY	Callie hardware on Designer Grey display board, 16"W x 11"H



PATENT D790,315



SOPHISTICATED

Sophisticated and streamlined, Callie will enhance any modern or contemporary space. Pairing clean lines and subtle curves, this pull collection not only looks great but also feels great in your hand thanks to its rounded grip.



Shown in Satin Bronze

Finishes



BNBDL
Brushed Pewter



DBAC
Brushed Oil Rubbed Bronze



MB
Matte Black



NI
Polished Nickel



PC
Polished Chrome



SBZ
Satin Bronze



SN
Satin Nickel



Knobs	Description	Overall Length	Width at Center	Projection	Hand Space	Foot Width	Foot Length	Inner Box	Price Code
775	round knob	1-1/8"	1-1/8"	1-7/16"	3/4"	3/8"	3/8"	25	[F]
775L	T-knob	2"	5/8"	1-3/8"	13/16"	3/8"	3/8"	25	[F]

Pulls	Center-to-Center	Overall Length	Width at Center	Projection	Hand Space	Foot Width	Foot Length	Inner Box	Price Code
775-96	96 mm (3-3/4") CC	4-3/4"	7/16"	1-3/8"	13/16"	3/8"	3/8"	10	[H]
775-128	128 mm (5-1/16") CC	6"	7/16"	1-3/8"	13/16"	3/8"	3/8"	10	[J]
775-160	160 mm (6-5/16") CC	7-1/4"	7/16"	1-3/8"	13/16"	3/8"	3/8"	10	[J]

Display	Description
DB817-GRY	Carmen hardware on Designer Grey display board, 16"W x 11"H



PATENT D787,297; D787,296



Shown in Brushed Gold

BRILLIANT

Bold, beautiful, and brilliant, Carmen is the perfect union of classic and contemporary. With its crystal-clear acrylic bar and industrial yet elegant stepped detail, this lustrous fusion evokes everlasting style with a modern-day twist.

Design Idea

Have fun and mix Carmen's beautiful acrylic with the solid options in Hayworth to instantly brighten any kitchen, bath, or closet. Find the Hayworth Collection on pages 56–57.

Finishes



BG
Brushed Gold



MB
Matte Black



NI
Polished Nickel



PC
Polished Chrome



SBZ
Satin Bronze



SN
Satin Nickel



Knobs	Description	Overall Length	Width at Center	Projection	Hand Space	Foot Width	Foot Length	Inner Box	Price Code
915	tri-cut knob	1-5/16"	1-1/4"	1"	9/16"	15/16"	15/16"	50	[D]
Z110	flared-base knob	1-3/16"	1-3/16"	1-1/16"	5/8"	3/4"	3/4"	30	[B]

Pulls	Center-to-Center	Overall Length	Width at Center	Projection	Hand Space	Foot Width	Foot Length	Inner Box	Price Code
737-96	96 mm (3-3/4") CC	4-1/4"	1/2"	1-3/16"	7/8"	1/2"	1/2"	20	[E]
737-128	128 mm (5-1/16") CC	5-1/2"	1/2"	1-3/16"	7/8"	1/2"	1/2"	15	[F]
737-160	160 mm (6-5/16") CC	6-3/4"	1/2"	1-3/16"	7/8"	1/2"	1/2"	10	[G]
737-12	12" CC appl. handle	12-15/16"	1"	1-3/4"	1-1/8"	15/16"	15/16"	5	[K]

Display	Description
DB941-GRY	Chesapeake hardware on Designer Grey display board, 16"W x 11"H

Finishes





Knobs	Description	Overall Length	Width at Center	Projection	Hand Space	Foot Width	Foot Length	Inner Box	Price Code
0251	flat-top knob	1-3/8"	1-3/8"	1-1/16"	11/16"	1-1/16"	1-1/16"	25	[C]
Z110	flared-base knob	1-3/16"	1-3/16"	1-1/16"	5/8"	3/4"	3/4"	30	[B]
Z111	button knob	1-1/4"	1-1/4"	1"	9/16"	11/16"	11/16"	30	[C]

Pulls	Center-to-Center	Overall Length	Width at Center	Projection	Hand Space	Foot Width	Foot Length	Inner Box	Price Code
Z281	3" CC	3-3/8"	3/8"	1-1/4"	13/16"	13/16"	3/8"	20	[D]
Z280	96 mm (3-3/4") CC	4-3/16"	3/8"	1-1/4"	13/16"	13/16"	3/8"	20	[E]
Z281-128	128 mm (5-1/16") CC	5-7/16"	3/8"	1-5/16"	7/8"	13/16"	3/8"	10	[F]
Z281-160	160 mm (6-5/16") CC	6-11/16"	3/8"	1-1/4"	13/16"	13/16"	3/8"	10	[H]
Z281-12	12" CC appl. handle	12-3/4"	5/8"	2-1/16"	1-3/8"	1-9/16"	3/4"	5	[K]
Z281-18*	18" CC appl. handle	18-3/4"	5/8"	2-1/16"	1-3/8"	1-9/16"	3/4"	5	[K]

Display	Description
DB955-GRY	Cordova hardware on Designer Grey display board, 16"W x 11"H

Finishes





Finishes



Knobs	Description	Overall Length	Width at Center	Projection	Hand Space	Foot Width	Foot Length	Inner Box	Price Code
519	T-knob	1-9/16"	13/16"	1-1/4"	11/16"	1/2"	1/2"	30	[F]

Pulls	Center-to-Center	Overall Length	Width at Center	Projection	Hand Space	Foot Width	Foot Length	Inner Box	Price Code
519-96	96 mm (3-3/4") CC	4-1/4"	3/4"	1-3/16"	11/16"	3/4"	1/2"	10	[H]
519-128	128 mm (5-1/16") CC	5-9/16"	3/4"	1-3/16"	11/16"	3/4"	1/2"	10	[K]
519-160	160 mm (6-5/16") CC	6-13/16"	3/4"	1-3/16"	11/16"	3/4"	1/2"	10	[K]
519-12	12" CC appl. handle	12-1/2"	3/4"	1-1/2"	1"	3/4"	1/2"	5	[K]
519-18*	18" CC appl. handle	18-1/2"	3/4"	1-1/2"	1"	3/4"	1/2"	5	[K]

Display	Description
DB944-GRY	Delgado hardware on Designer Grey display board, 16" W x 11" H



PATENT D612,703; D598,269

*18" appliance handles are packaged with 10-24 standard and 10-24 breakaway screws.

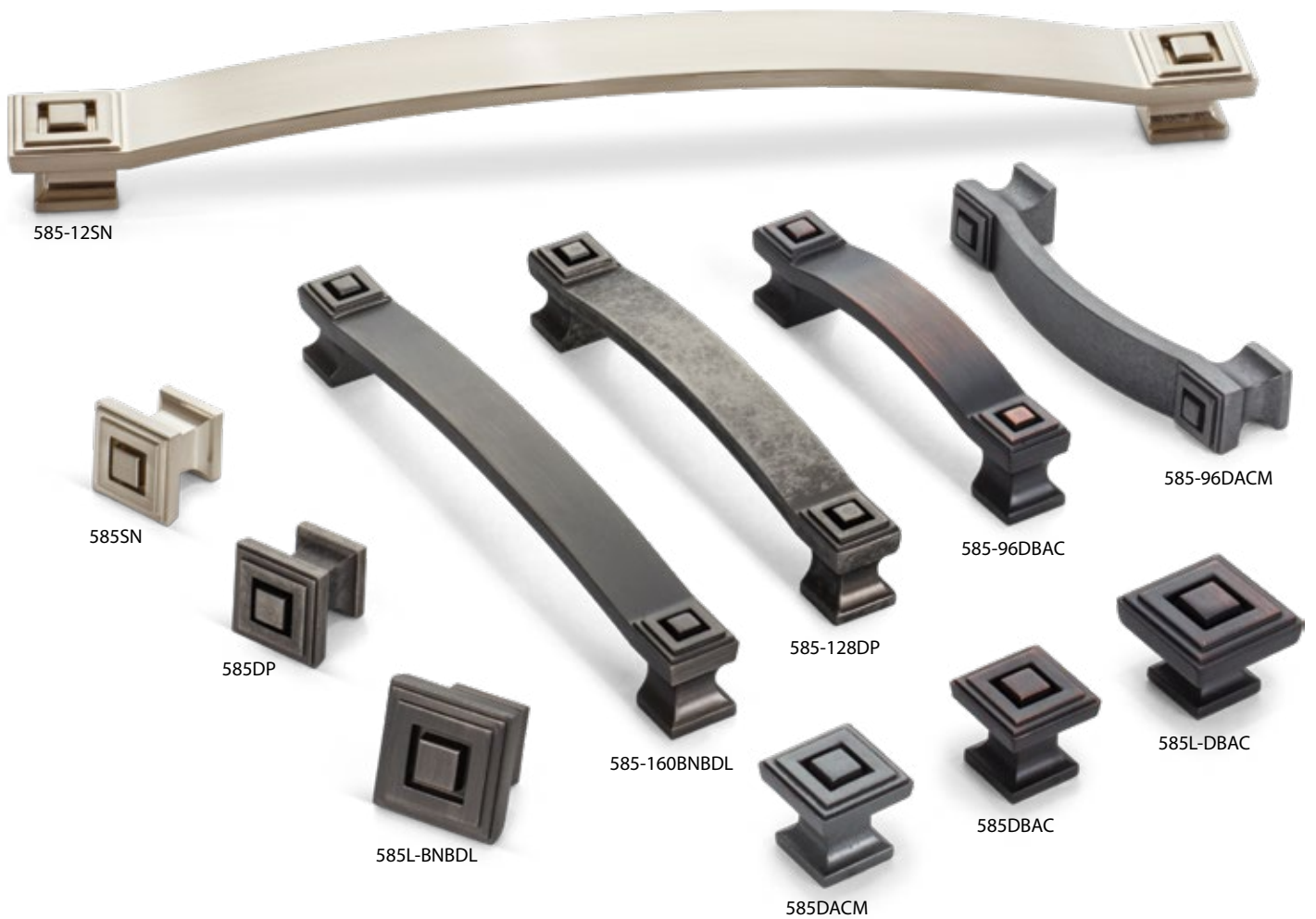

Knobs	Description	Overall Length	Width at Center	Projection	Hand Space	Foot Width	Foot Length	Inner Box	Price Code
585	small square knob	1"	1"	1"	11/16"	3/4"	3/4"	20	[F]
585L	large square knob	1-1/4"	1-1/4"	1"	5/8"	3/4"	3/4"	20	[G]
Pulls	Center-to-Center	Overall Length	Width at Center	Projection	Hand Space	Foot Width	Foot Length	Inner Box	Price Code
585-96	96 mm (3-3/4") CC	4-1/2"	3/4"	1-1/8"	7/8"	11/16"	5/8"	10	[H]
585-128	128 mm (5-1/16") CC	5-13/16"	3/4"	1-1/8"	7/8"	11/16"	5/8"	10	[J]
585-160	160 mm (6-5/16") CC	7-1/16"	3/4"	1-1/8"	7/8"	11/16"	5/8"	10	[K]
585-12	12" CC appl. handle	13-1/4"	1-1/4"	1-1/2"	1-1/4"	3/4"	7/8"	5	[K]

Display	Description
DB980-GRY	Delmar hardware on Designer Grey display board, 16"W x 11"H

Finishes



D680,409; D680,414;
D680,408

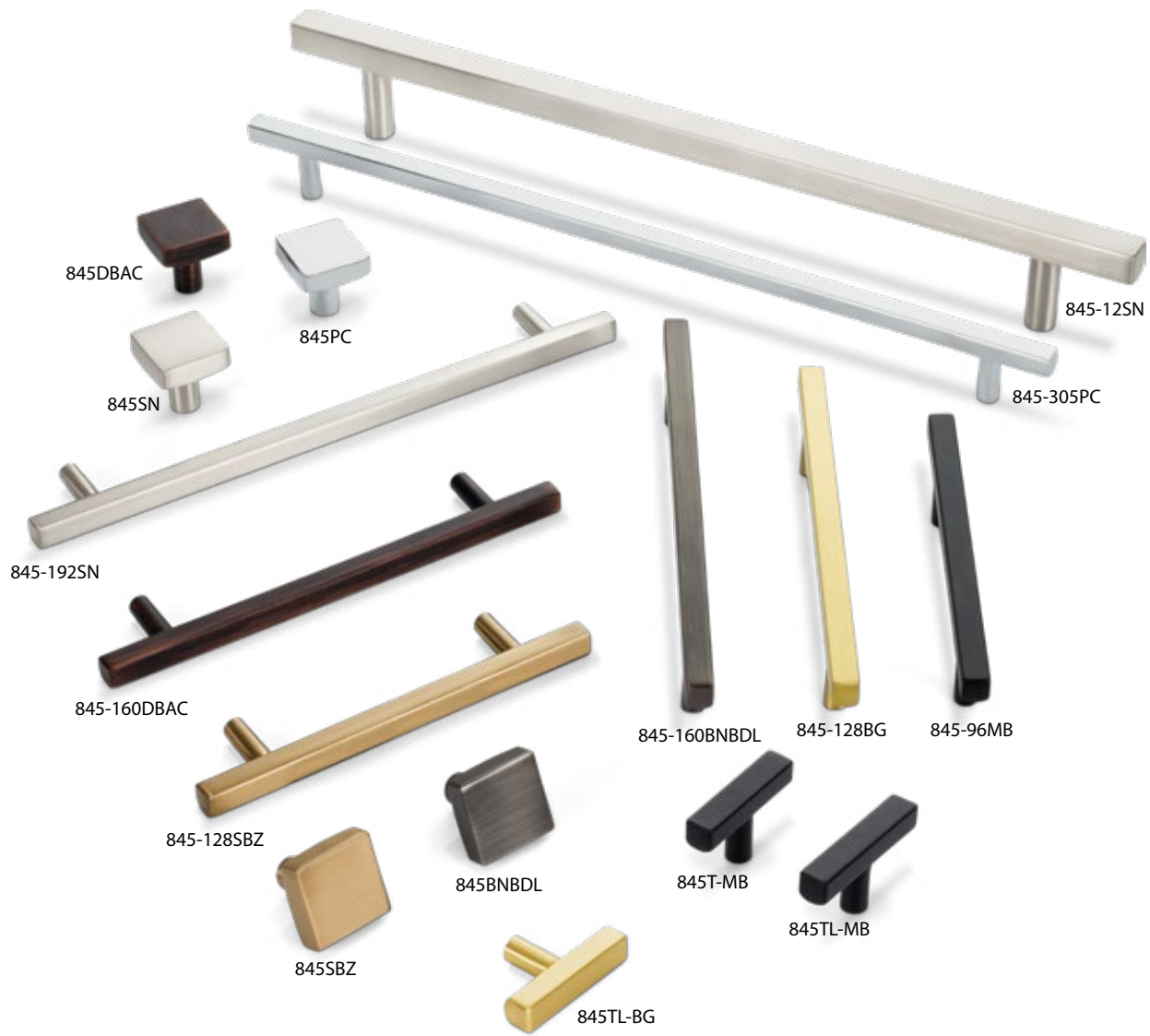

Knobs	Description	Overall Length	Width at Center	Projection	Hand Space	Foot Width	Foot Length	Inner Box	Price Code
845	square knob	1-1/8"	1-1/8"	1-3/16"	3/4"	7/16"	7/16"	20	[D]
845T	T-knob	2"	7/16"	1-3/16"	3/4"	3/8"	3/8"	20	[D]
845TL	long T-knob	2-1/4"	7/16"	1-3/16"	3/4"	3/8"	3/8"	20	[E]

Pulls	Center-to-Center	Overall Length	Width at Center	Projection	Hand Space	Foot Width	Foot Length	Inner Box	Price Code
845-96	96 mm (3-3/4") CC	5-3/4"	3/8"	1-3/16"	13/16"	5/16"	5/16"	10	[F]
845-128	128 mm (5-1/16") CC	7-1/16"	3/8"	1-3/16"	13/16"	5/16"	5/16"	10	[F]
845-160	160 mm (6-5/16") CC	8-5/16"	3/8"	1-3/16"	13/16"	5/16"	5/16"	10	[G]
845-192	192 mm (7-9/16") CC	9-9/16"	3/8"	1-3/16"	13/16"	5/16"	5/16"	10	[H]
845-305	305 mm (12") CC	14"	3/8"	1-3/16"	13/16"	5/16"	5/16"	10	[K]
845-12	12" CC appl. handle	15"	5/8"	1-7/8"	1-1/4"	1/2"	1/2"	5	[K]
845-18*	18" CC appl. handle	21"	5/8"	1-7/8"	1-1/4"	1/2"	1/2"	5	[K]

Display	Description
DB814-GRY	Dominique hardware on Designer Grey display board, 16"W x 11"H

*18" appliance handles are packaged with 10-24 standard and 10-24 breakaway screws.



DARING

Dominique fuses daring lines with a delicate contour, resulting in a perfect balance of grace and power. With an abundance of pull lengths and knob shapes to choose from, this collection is a winning choice for transitional and contemporary designs.



Shown in Satin Bronze

Finishes



BG
Brushed Gold



BNBDL
Brushed Pewter



DBAC
Brushed Oil
Rubbed Bronze



MB
Matte Black



PC
Polished Chrome



SBZ
Satin Bronze



SN
Satin Nickel



Knobs	Description	Overall Length	Width at Center	Projection	Hand Space	Foot Width	Foot Length	Inner Box	Price Code
3980	round knob	1-1/4"	1-1/4"	1"	5/8"	1"	1"	20	[D]
Pulls	Center-to-Center	Overall Length	Width at Center	Projection	Hand Space	Foot Width	Foot Length	Inner Box	Price Code
Z290-3	3" CC	3-3/8"	1/2"	1-5/16"	13/16"	3/8"	3/8"	25	[D]
Z290-96	96 mm (3-3/4") CC	4-1/4"	1/2"	1-5/16"	13/16"	1/2"	1/2"	20	[D]
Z290-128	128 mm (5-1/16") CC	5-1/2"	1/2"	1-7/16"	7/8"	1/2"	1/2"	15	[G]
Z290-160	160 mm (6-5/16") CC	6-3/4"	9/16"	1-9/16"	1"	1/2"	1/2"	10	[H]
Z290-12	12" CC appl. handle	13"	15/16"	2-1/8"	1-1/4"	1"	1"	5	[K]

Display	Description
DB954-GRY	Durham hardware on Designer Grey display board, 16"W x 11"H

Finishes





Knobs	Description	Overall Length	Width at Center	Projection	Hand Space	Foot Width	Foot Length	Inner Box	Price Code
618†	small T-knob	2-5/8"	11/16"	1-1/4"	9/16"	3/4"	3/4"	25	[D]
618L†	large T-knob	2-15/16"	13/16"	1-1/2"	3/4"	11/16"	11/16"	15	[F]

Pulls	Center-to-Center	Overall Length	Width at Center	Projection	Hand Space	Foot Width	Foot Length	Inner Box	Price Code
718†	128 mm (5-1/16") CC	5-3/4"	11/16"	1-7/16"	3/4"	11/16"	11/16"	25	[F]
718-128†	128 mm (5-1/16") CC bail pull	5-15/16"	11/16"	1-1/4"	9/16"	15/16"	15/16"	10	[H]
Z718-12†	12" CC appl. handle	13-5/16"	1-1/16"	2-3/16"	1-1/8"	1-5/16"	1-5/16"	5	[K]

These products are being retired.
Check availability online or call for products marked with "†"

Finishes





Knobs	Description	Overall Length	Width at Center	Projection	Hand Space	Foot Width	Foot Length	Inner Box	Price Code
484	round knob	1-1/4"	1-1/4"	15/16"	9/16"	7/8"	7/8"	20	[D]

Pulls	Center-to-Center	Overall Length	Width at Center	Projection	Hand Space	Foot Width	Foot Length	Inner Box	Price Code
484-32	32 mm (1-1/4") CC	2-1/8"	9/16"	15/16"	-	9/16"	2-1/8"	15	[D]
484-396	3" CC & 96 mm (3-3/4") CC	4-5/8"	9/16"	15/16"	-	9/16"	4-5/8"	20	[F]
484-128160	128 mm (5-1/16") CC & 160 mm (6-5/16") CC	7-1/8"	9/16"	15/16"	-	9/16"	7-1/8"	10	[H]
484-192224	192 mm (7-9/16") CC & 224 mm (8-13/16") CC	9-5/8"	9/16"	15/16"	-	9/16"	9-5/8"	15	[J]
484-305	305 mm (12") CC	12-13/16"	9/16"	15/16"	-	9/16"	12-13/16"	5	[K]

Display	Description
DB809-GRY	Elara hardware on Designer Grey display board, 16"W x 11"H

3 pull sizes offer 2 center-to-center options

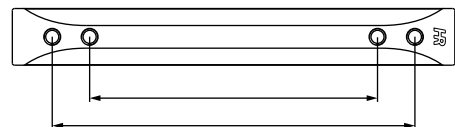



Shown in Satin Bronze

BOUNDLESS

Elara's chic, European style brings a fresh, upscale perspective to any room. Mix bold round knobs with elegantly curved pinch pulls for boundless design possibilities.

Design Idea

Create a snag-free space (like in closets and laundry rooms) by choosing pulls that have feet that touch the face of the cabinet instead of having an overhang.

Finishes



BNBDL
Brushed Pewter



DBAC
Brushed Oil
Rubbed Bronze



MB
Matte Black



PC
Polished Chrome



SBZ
Satin Bronze



SN
Satin Nickel



Knobs	Description	Overall Length	Width at Center	Projection	Hand Space	Foot Width	Foot Length	Inner Box	Price Code
165	geometric knob	1-1/4"	7/8"	1-1/8"	13/16"	9/16"	13/16"	20	[E]

Pulls	Center-to-Center	Overall Length	Width at Center	Projection	Hand Space	Foot Width	Foot Length	Inner Box	Price Code
165-96	96 mm (3-3/4") CC	4-1/2"	9/16"	1-3/16"	7/8"	15/16"	3/4"	10	[G]
165-128	128 mm (5-1/16") CC	5-13/16"	9/16"	1-3/16"	7/8"	15/16"	3/4"	10	[H]
165-160	160 mm (6-5/16") CC	7-1/16"	9/16"	1-3/16"	7/8"	15/16"	3/4"	10	[J]
165-12	12" CC appl. handle	13"	13/16"	1-5/8"	1-1/4"	1-1/4"	1"	5	[K]

Display	Description
DB996-GRY	Ella hardware on Designer Grey display board, 16"W x 11"H



PATENT D737,112; D728,343



DAZZLING

With its soft square design and wider chamfer with strap detail, Ella's dazzling personality adds brilliance to any kitchen. Accented with a matching faceted knob, resembling an emerald-cut jewel, this collection is the epitome of "jewelry for the kitchen."



Shown in Satin Nickel

Finishes



BNBDL
Brushed Pewter



DBAC
Brushed Oil
Rubbed Bronze



NI
Polished Nickel



PC
Polished Chrome



SN
Satin Nickel



G110L-SN



G110SN



G150PC



G120DBAC



G150L-PC



G130SN



G130L-SN



G140BNBDL



G120L-DBAC



G140L-BNBDL

Knobs	Description	Overall Length	Width at Center	Projection	Hand Space	Foot Width	Foot Length	Inner Box	Price Code
G110	small oval	1-1/4"	3/4"	1-3/8"	5/8"	7/8"	7/8"	10	[G]
G110L	large oval	1-5/8"	1"	1-11/16"	11/16"	7/8"	7/8"	10	[J]
G120	small button	1-7/16"	1-7/16"	1-9/16"	11/16"	7/8"	7/8"	10	[G]
G120L	large button	1-3/4"	1-3/4"	1-5/8"	15/16"	7/8"	7/8"	10	[J]
G130	small sphere	1-1/16"	1-1/16"	1-7/16"	1/2"	11/16"	11/16"	10	[G]
G130L	large sphere	1-3/8"	1-3/8"	1-5/8"	1/2"	7/8"	7/8"	10	[H]
G140	small square	1"	1"	1-3/16"	7/8"	11/16"	11/16"	10	[G]
G140L	large square	1-3/8"	1-3/8"	1-5/16"	7/8"	7/8"	7/8"	10	[J]
G150	small faceted	1"	1"	1-1/4"	11/16"	11/16"	11/16"	10	[G]
G150L	large faceted	1-1/4"	1-1/4"	1-1/2"	3/4"	7/8"	7/8"	10	[H]

The Harlow knobs have a post that needs an easy extra step to achieve a flush mount. Once you have drilled your hole with a 3/16" bit, use a 1/4" bit to expand the hole on the face of the door/drawer front to seat the post of the Harlow knob.

Display	Description
DB992-GRY	Harlow hardware on Designer Grey display board, 16"W x 11"H



GLAMOROUS

Recalling the glamorous era of Old Hollywood, Harlow's glass knobs add excitement and radiance to any kitchen, bath, or closet. This knob collection offers five alluring shapes that are the perfect accent to traditional or transitional design schemes.



G210L shown in Polished Chrome base

Base Finishes



BNBDL
Brushed Pewter



DBAC
Brushed Oil
Rubbed Bronze



PC
Polished Chrome



SN
Satin Nickel



Knobs	Description	Overall Length	Width at Center	Projection	Hand Space	Foot Width	Foot Length	Inner Box	Price Code
885	round knob	1-1/8"	1-1/8"	1-7/16"	3/4"	3/8"	3/8"	25	[E]
885L	T-knob	2"	5/8"	1-3/8"	13/16"	3/8"	3/8"	25	[E]

Pulls	Center-to-Center	Overall Length	Width at Center	Projection	Hand Space	Foot Width	Foot Length	Inner Box	Price Code
885-96	96 mm (3-3/4") CC	4-3/4"	7/16"	1-3/8"	13/16"	3/8"	3/8"	10	[G]
885-128	128 mm (5-1/16") CC	6"	7/16"	1-3/8"	13/16"	3/8"	3/8"	10	[H]
885-160	160 mm (6-5/16") CC	7-1/4"	7/16"	1-3/8"	13/16"	3/8"	3/8"	10	[H]
885-192	192 mm (7-9/16") CC	8-1/2"	7/16"	1-3/8"	13/16"	3/8"	3/8"	10	[J]
885-224	224 mm (8-13/16") CC	9-3/4"	7/16"	1-3/8"	13/16"	3/8"	3/8"	10	[J]
885-305	305 mm (12") CC pull	12-15/16"	7/16"	1-3/8"	13/16"	3/8"	3/8"	10	[K]

Display	Description
DB999-GRY	Hayworth hardware on Designer Grey display board, 16"W x 11"H



PATENT D787,297; D787,296



INDUSTRIAL

Industrial and elegant styles are not often paired together, but Hayworth personifies this combination. The simple yet trendy pull and knob collection offers a clean design while providing a substantial profile through its stepped detail.

Design Idea

Shake things up and strategically mix in matching acrylic knobs and pulls from Carmen with Hayworth to make a fun statement. Find the Carmen Collection on pages 40–41.



Shown in Satin Bronze

Finishes



BG
Brushed Gold



MB
Matte Black



NI
Polished Nickel



PC
Polished Chrome



SBZ
Satin Bronze



SN
Satin Nickel



Knobs	Description	Overall Length	Width at Center	Projection	Hand Space	Foot Width	Foot Length	Inner Box	Price Code
650	oval knob	1-7/8"	1"	1"	3/4"	5/8"	5/8"	25	[D]
Pulls	Center-to-Center	Overall Length	Width at Center	Projection	Hand Space	Foot Width	Foot Length	Inner Box	Price Code
650-96	96 mm (3-3/4") CC	4-3/8"	1/2"	1-1/4"	1"	7/8"	5/8"	30	[E]
650-128	128 mm (5-1/16") CC	5-11/16"	1/2"	1-1/4"	1"	7/8"	5/8"	25	[F]
650-160	160 mm (6-5/16") CC	6-15/16"	1/2"	1-3/8"	1-1/8"	7/8"	5/8"	10	[G]
650-12	12" CC appl. handle	13"	7/8"	1-9/16"	1-3/16"	1-3/8"	1"	5	[K]

Display	Description
DB962-GRY	Hudson hardware on Designer Grey display board, 16"W x 11"H



SEAMLESS

The smooth and seamless blend of clean modern lines and a soft conventional shape make Hudson the perfect compromise in the contemporary versus traditional dilemma. This pull has a curved handle that leads to delicate oval feet for a comfortable, sleek look that is sure to satisfy any taste.

Finishes



BNBDL
Brushed Pewter



DBAC
Brushed Oil Rubbed Bronze



PC
Polished Chrome



SN
Satin Nickel



Knobs	Description	Overall Length	Width at Center	Projection	Hand Space	Foot Width	Foot Length	Inner Box	Price Code
188	small knob	7/8"	7/8"	1-3/8"	1/2"	11/16"	11/16"	20	[E]
188L	large knob	1"	1"	1-7/16"	1/2"	13/16"	13/16"	15	[F]

Pulls	Center-to-Center	Overall Length	Width at Center	Projection	Hand Space	Foot Width	Foot Length	Inner Box	Price Code
188-96	96 mm (3-3/4") CC	4-3/8"	5/8"	1-7/16"	13/16"	5/8"	5/8"	15	[G]
188-128	128 mm (5-1/16") CC	5-11/16"	5/8"	1-7/16"	13/16"	5/8"	5/8"	15	[H]
188-160	160 mm (6-5/16") CC	6-15/16"	5/8"	1-7/16"	13/16"	5/8"	5/8"	10	[J]

Display	Description
DB991-GRY	Katharine hardware on Designer Grey display board, 16"W x 11"H



PATENT D728,341; D729,037



Shown in Brushed Pewter

DRAMATIC

Katharine brings a bit of dramatic glamour to any home. Harkening days of Old Hollywood, this alluring and curvaceous square knob sits atop stacked square feet. The soft square is echoed in the coordinating pull and is combined with a slightly higher hand clearance, making it a great option for aging in place. Choose from four classic finishes to complete any traditional or transitional space.

Finishes



BNBDL
Brushed Pewter



DBAC
Brushed Oil Rubbed Bronze



PC
Polished Chrome



SN
Satin Nickel



Knobs	Description	Overall Length	Width at Center	Projection	Hand Space	Foot Width	Foot Length	Inner Box	Price Code
51	T-knob	2"	3/4"	1-5/16"	11/16"	7/16"	3/8"	20	[H]

Pulls	Center-to-Center	Overall Length	Width at Center	Projection	Hand Space	Foot Width	Foot Length	Inner Box	Price Code
596	96 mm (3-3/4") CC	5-3/8"	9/16"	1-5/16"	11/16"	7/16"	3/8"	20	[H]
5128	128 mm (5-1/16") CC	6-5/8"	9/16"	1-5/16"	11/16"	7/16"	3/8"	20	[H]
5192	192 mm (7-9/16") CC	9-1/8"	9/16"	1-5/16"	11/16"	7/16"	3/8"	10	[J]
5224	224 mm (8-13/16") CC	10-3/8"	9/16"	1-5/16"	11/16"	7/16"	3/8"	10	[J]
5319	319 mm (12-9/16") CC	14-1/8"	9/16"	1-5/16"	11/16"	7/16"	3/8"	10	[K]
5480*	480 mm (18-7/8") CC	20-1/2"	9/16"	1-5/16"	11/16"	7/16"	3/8"	10	[K]
5673*	673 mm (26-1/2") CC	28-1/16"	9/16"	1-5/16"	11/16"	7/16"	3/8"	10	[K]
5900*	900 mm (35-7/16") CC	37"	9/16"	1-5/16"	11/16"	7/16"	3/8"	5	[K]

*Satin Nickel only

Display	Description
DB963-GRY	Key Grande hardware on Designer Grey display board, 16"W x 11"H



Shown in Brushed Gold

REFINED

The simple, clean lines of this beveled bar pull blend with any cabinet style in kitchens, baths, and even laundry rooms. Key Grande's added strap detail offers a refined upgrade to the traditional bar pull.

Finishes



BG
Brushed Gold
(up to 319 mm CC)



MB
Matte Black
(up to 319 mm CC)



SN
Satin Nickel
(all lengths)



MBBG
Matte Black
with Brushed Gold
(up to 319 mm CC)



MBSN
Matte Black
with Satin Nickel
(up to 319 mm CC)

Key West & Key Largo



Knobs	Description	Overall Length	Width at Center	Projection	Hand Space	Foot Width	Foot Length	Inner Box	Price Code
48	T-knob	1-7/8"	9/16"	1-7/16"	7/8"	1/2"	1/2"	30	[D]

Pulls	Center-to-Center	Overall Length	Width at Center	Projection	Hand Space	Foot Width	Foot Length	Inner Box	Price Code
146	96 mm (3-3/4") CC	5-3/4"	9/16"	1-7/16"	7/8"	1/2"	1/2"	10	[F]
152	96 mm (3-3/4") CC	6"	9/16"	1-7/16"	7/8"	1/2"	1/2"	10	[F]
178	128 mm (5-1/16") CC	7"	9/16"	1-7/16"	7/8"	1/2"	1/2"	10	[G]
242*	192 mm (7-9/16") CC	9-1/2"	9/16"	1-7/16"	7/8"	1/2"	1/2"	10	[G]
274*	224 mm (8-13/16") CC	10-13/16"	9/16"	1-7/16"	7/8"	1/2"	1/2"	10	[H]
370*	320mm (12-5/8") CC	14-9/16"	9/16"	1-7/16"	7/8"	1/2"	1/2"	10	[H]
530†	480 mm (18-7/8") CC	20-7/8"	9/16"	1-7/16"	7/8"	1/2"	1/2"	10	[J]
722‡	673 mm (26-1/2") CC	28-7/16"	9/16"	1-7/16"	7/8"	1/2"	1/2"	10	[K]
950‡	900 mm (35-7/16") CC	37-3/8"	9/16"	1-7/16"	7/8"	1/2"	1/2"	10	[K]

Display	Description
DB905-GRY	Key West & Key Largo combined hardware on Designer Grey display board, 16"W x 11"H

*Available in Brushed Gold, Matte Black, Satin Bronze, and Satin Nickel finishes
 †Only available in Satin Nickel finish



ENDURING

The enduring bar pull design is comfortable, distinguished, and always a crowd-pleaser. Expanded to offer top-trending finishes and extended lengths for oversized drawers, the presence of Key West and Key Largo will stand the test of time.

Design Idea

For a streamlined and more modern look, choose longer pulls to complement wider drawers.



Shown in Matte Black

Finishes



BG
Brushed Gold
(up to 320 mm CC)



MB
Matte Black
(up to 320 mm CC)



ORB
Dark Bronze
(up to 128 mm CC)



SBZ
Satin Bronze
(up to 320 mm CC)



SN
Satin Nickel
(all lengths)



Larkin 1 & 2

EDGY

Edgy with undiluted style, Larkin is making its statement. The classic beveled bar pairs perfectly with its fierce squared foot to create a look that will complement any style of cabinetry. Captivate and inspire with five solid finishes or opt for something moody and expressive with four mixed options.



Shown in Matte Black w/ Satin Bronze

Larkin 3 & 4

Design Idea

To add even more drama, pair Larkin with its sister collection Spencer, featuring clear acrylic pieces (see pages 102–103).



Shown in Brushed Gold



Larkin 1 & 2



Knobs	Description	Overall Length	Width at Center	Projection	Hand Space	Foot Width	Foot Length	Inner Box	Price Code
478T	T-knob	2-3/8"	7/16"	1-7/16"	7/8"	11/16"	1/2"	15	[E]

Pulls	Center-to-Center	Overall Length	Width at Center	Projection	Hand Space	Foot Width	Foot Length	Inner Box	Price Code
478-96	96 mm (3-3/4") CC	6-1/8"	7/16"	1-7/16"	7/8"	11/16"	1/2"	10	[F]
478-128	128 mm (5-1/16") CC	7-3/8"	7/16"	1-7/16"	7/8"	11/16"	1/2"	10	[F]
478-160	160 mm (6-5/16") CC	8-11/16"	7/16"	1-7/16"	7/8"	11/16"	1/2"	10	[G]
478-192	192 mm (7-9/16") CC	9-15/16"	7/16"	1-7/16"	7/8"	11/16"	1/2"	10	[G]
478-305	305 mm (12") CC	14-3/8"	7/16"	1-7/16"	7/8"	11/16"	1/2"	5	[K]
478-12	12" CC appl. handle	15-3/16"	3/4"	2-3/16"	1-1/4"	1-1/8"	5/8"	5	[K]
478-18*	18" CC appl. handle	21-3/16"	3/4"	2-3/16"	1-1/4"	1-1/8"	5/8"	5	[K]

Solid Finishes



Mixed Finishes



*18" appliance handles are packaged with 10-24 standard and 10-24 breakaway screws.

Larkin 3 & 4 (Knurled)

New collections

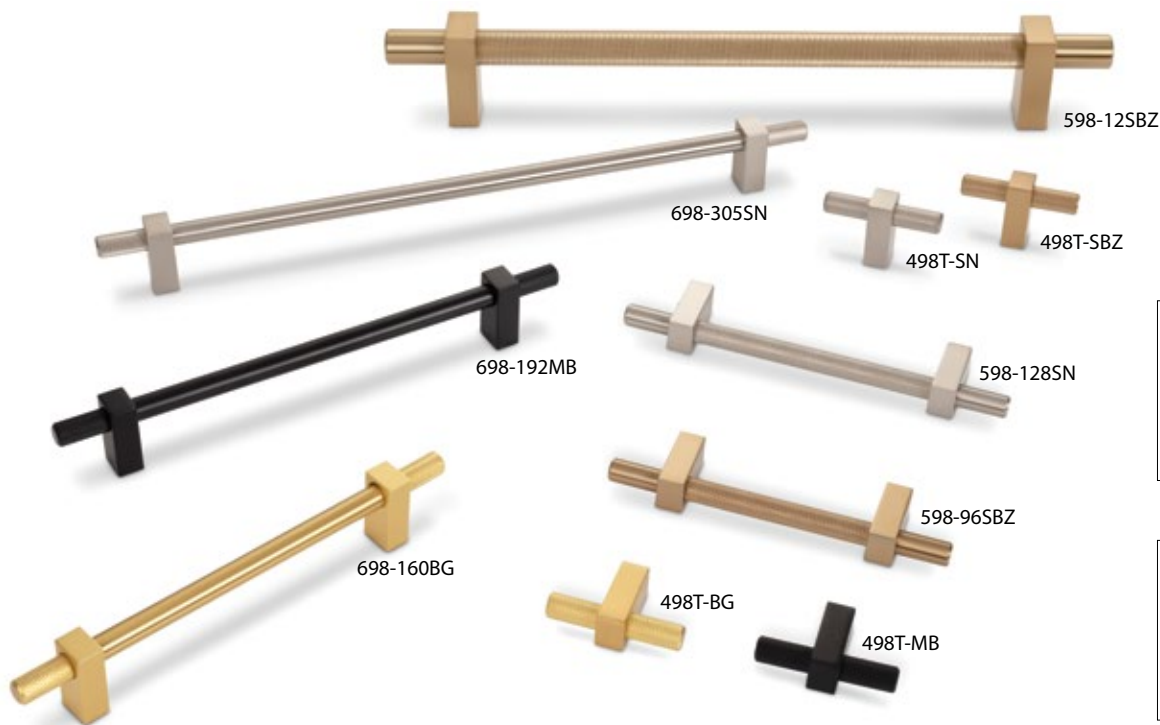

Knurled Center

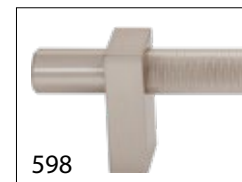

Knurled Ends

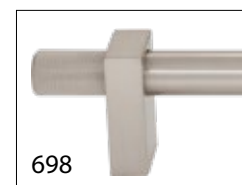

Knobs	Description	Overall Length	Width at Center	Projection	Hand Space	Foot Width	Foot Length	Inner Box	Price Code
498T	T-knob	2-3/8"	11/16"	1-7/16"	7/8"	1/2"	11/16"	15	[F]

Pulls	Center-to-Center	Overall Length	Width at Center	Projection	Hand Space	Foot Width	Foot Length	Inner Box	Price Code
598-96	96 mm (3-3/4") CC	6-1/8"	11/16"	1-7/16"	7/8"	1/2"	11/16"	10	[H]
598-128	128 mm (5-1/16") CC	7-3/8"	11/16"	1-7/16"	7/8"	1/2"	11/16"	10	[H]
598-160	160 mm (6-5/16") CC	8-11/16"	11/16"	1-7/16"	7/8"	1/2"	11/16"	10	[H]
598-192	192 mm (7-9/16") CC	9-15/16"	11/16"	1-7/16"	7/8"	1/2"	11/16"	10	[J]
598-305	305 mm (12") CC	14-3/8"	11/16"	1-7/16"	7/8"	1/2"	11/16"	5	[K]
598-12	12" CC appl. handle	14-3/8"	1-1/8"	2-3/16"	1-1/4"	5/8"	1-1/8"	5	[K]
598-18*	18" CC appl. handle	20-3/8"	1-1/8"	2-3/16"	1-1/4"	5/8"	1-1/8"	5	[K]

Pulls	Center-to-Center	Overall Length	Width at Center	Projection	Hand Space	Foot Width	Foot Length	Inner Box	Price Code
698-96	96 mm (3-3/4") CC	6-1/8"	11/16"	1-7/16"	7/8"	1/2"	11/16"	10	[H]
698-128	128 mm (5-1/16") CC	7-3/8"	11/16"	1-7/16"	7/8"	1/2"	11/16"	10	[H]
698-160	160 mm (6-5/16") CC	8-11/16"	11/16"	1-7/16"	7/8"	1/2"	11/16"	10	[H]
698-192	192 mm (7-9/16") CC	9-15/16"	11/16"	1-7/16"	7/8"	1/2"	11/16"	10	[J]
698-305	305 mm (12") CC	14-3/8"	11/16"	1-7/16"	7/8"	1/2"	11/16"	5	[K]
698-12	12" CC appl. handle	14-3/8"	1-1/8"	2-3/16"	1-1/4"	5/8"	1-1/8"	5	[K]
698-18*	18" CC appl. handle	20-3/8"	1-1/8"	2-3/16"	1-1/4"	5/8"	1-1/8"	5	[K]

Display	Description
DB821-GRY	Larkin 1 hardware on Designer Grey display board, 16"W x 11"H
DB822-GRY	Larkin 2 hardware on Designer Grey display board, 16"W x 11"H
DB827-GRY	Larkin combination on Designer Grey display board, 16"W x 11"H

Finishes



BG Brushed Gold **MB** Matte Black **SBZ** Satin Bronze **SN** Satin Nickel

*18" appliance handles are packaged with 10-24 standard and 10-24 breakaway screws.



Knobs	Description	Overall Length	Width at Center	Projection	Hand Space	Foot Width	Foot Length	Inner Box	Price Code
218	fleur-de-lis knob	1-3/8"	1-3/8"	1-1/4"	3/4"	7/8"	7/8"	30	[F]
317	circles knob	1-3/8"	1-3/8"	1-1/8"	3/4"	11/16"	11/16"	20	[F]
417	Baroque pattern knob	1-3/8"	1-3/8"	1-1/8"	3/4"	3/4"	3/4"	30	[F]

Pulls	Center-to-Center	Overall Length	Width at Center	Projection	Hand Space	Foot Width	Foot Length	Inner Box	Price Code
317-96	96 mm (3-3/4") CC	4-3/8"	1/2"	1-1/4"	15/16"	9/16"	9/16"	20	[G]
317-128	128 mm (5-1/16") CC	5-5/8"	1/2"	1-3/8"	1-1/16"	9/16"	9/16"	20	[H]
317-160	160 mm (6-5/16") CC	6-7/8"	1/2"	1-7/16"	1-1/16"	9/16"	9/16"	15	[H]
317-12	12" CC appl. handle	12-15/16"	1-1/16"	2-3/16"	1-11/16"	7/8"	7/8"	5	[K]

Finishes



Display	Description
DB945-GRY	Lafayette hardware on Designer Grey display board, 16"W x 11"H



D605,924; D602,334;
D637,059

PATENT



Knobs	Description	Overall Length	Width at Center	Projection	Hand Space	Foot Width	Foot Length	Inner Box	Price Code
259	T-knob	2"	1/2"	1-3/16"	13/16"	5/16"	1/2"	30	[E]

Pulls	Center-to-Center	Overall Length	Width at Center	Projection	Hand Space	Foot Width	Foot Length	Inner Box	Price Code
259-96	96 mm (3-3/4") CC	4-3/16"	1/2"	1-3/16"	13/16"	5/16"	5/16"	15	[H]
259-128	128 mm (5-1/16") CC	5-7/16"	1/2"	1-3/16"	13/16"	5/16"	5/16"	10	[H]
259-160	160 mm (6-5/16") CC	6-11/16"	1/2"	1-3/16"	13/16"	5/16"	5/16"	10	[J]
259-192	192 mm (7-9/16") CC	8"	1/2"	1-3/16"	13/16"	5/16"	5/16"	10	[J]

Display	Description
DB986-GRY	Lexa hardware on Designer Grey display board, 16"W x 11"H

Finishes



U.S.
PATENT
D718,111;
D719,008



Pulls	Center-to-Center	Overall Length	Width at Center	Projection	Hand Space	Foot Width	Foot Length	Inner Box	Price Code
286-96	96 mm (3-3/4") CC	5-1/8"	5/16"	1-3/16"	13/16"	5/16"	7/8"	10	[F]
286-128	128 mm (5-1/16") CC	6-3/8"	5/16"	1-3/16"	13/16"	5/16"	7/8"	10	[G]
286-160	160 mm (6-5/16") CC	7-11/16"	5/16"	1-3/16"	13/16"	5/16"	7/8"	10	[H]
286-192	192 mm (7-9/16") CC	8-15/16"	5/16"	1-3/16"	13/16"	5/16"	7/8"	10	[H]
286-224	224 mm (8-13/16") CC	10-3/16"	5/16"	1-3/16"	13/16"	5/16"	7/8"	10	[J]

Display	Description
DB800-GRY	Leyton hardware on Designer Grey display board, 16"W x 11"H



Shown in Satin Bronze

DISTINCTIVE

Leyton's relaxed yet distinctive asymmetrical silhouette is fun and flexible. An ideal complement to mid-century modern design with its clean lines and gentle curves, this pull collection also harmonizes with contemporary design's straight lines and geometric shapes.

Design Idea

For a bold, modern feel, use gold-tone hardware on black cabinets.

Finishes



BNBDL
Brushed Pewter



DBAC
Brushed Oil
Rubbed Bronze



MB
Matte Black



NI
Polished Nickel



PC
Polished Chrome



SBZ
Satin Bronze



SN
Satin Nickel



Knobs	Description	Overall Length	Width at Center	Projection	Hand Space	Foot Width	Foot Length	Inner Box	Price Code
329	round knob	1-1/4"	1-1/4"	1-1/4"	5/8"	3/8"	3/8"	20	[D]
329L	rounded rectangle knob	1-1/2"	1"	1-5/16"	3/4"	3/8"	3/8"	20	[D]

Pulls	Center-to-Center	Overall Length	Width at Center	Projection	Hand Space	Foot Width	Foot Length	Inner Box	Price Code
329-96	96 mm (3-3/4") CC	4-9/16"	3/8"	1-3/16"	7/8"	5/8"	5/8"	10	[E]
329-128	128 mm (5-1/16") CC	5-7/8"	3/8"	1-3/16"	7/8"	5/8"	5/8"	10	[F]
329-160	160 mm (6-5/16") CC	7-1/8"	7/16"	1-3/16"	7/8"	5/8"	5/8"	10	[G]
329-192	192 mm (7-9/16") CC	8-7/16"	7/16"	1-3/16"	7/8"	5/8"	5/8"	10	[G]
329-305	305 mm (12") CC	12-15/16"	7/16"	1-3/16"	7/8"	5/8"	5/8"	10	[K]
329-12	12" CC appl. handle	13-7/16"	11/16"	1-3/4"	1-1/4"	1"	1"	5	[K]
329-18*	18" CC appl. handle	19-7/16"	11/16"	1-3/4"	1-1/4"	1"	1"	5	[K]

Display	Description
DB826-GRY	Loxley hardware on Designer Grey display board, 16"W x 11"H

*18" appliance handles are packaged with 10-24 standard and 10-24 breakaway screws.



**Shown in
Brushed Oil Rubbed Bronze**

NOTABLE

The Loxley cabinet knob and pull collection is a notable example of elegant simplicity. With its soft and clean design, Loxley effortlessly melds with a variety of decor styles. Its two distinct cabinet knob shapes, round and rounded rectangle, complement its vast array of pull lengths. Each pull features a rounded grip, ensuring a comfortable feel in the hand. With seven beautiful finishes to choose from, this collection reflects meticulous craftsmanship, adding a subtle yet impressive touch of sophistication to any living space.

Finishes



BG
Brushed Gold



BNBDL
Brushed Pewter



DBAC
Brushed Oil
Rubbed Bronze



MB
Matte Black



PC
Polished Chrome



SBZ
Satin Bronze



SN
Satin Nickel



Knobs	Description	Overall Length	Width at Center	Projection	Hand Space	Foot Width	Foot Length	Inner Box	Price Code
3991	oval knob	1-9/16"	1"	1-5/8"	3/4"	11/16"	11/16"	25	[E]

Pulls	Center-to-Center	Overall Length	Width at Center	Projection	Hand Space	Foot Width	Foot Length	Inner Box	Price Code
8233	3" CC	4-15/16"	1-7/16"	1"	7/8"	1-7/16"	4-15/16"	25	[D]

Display	Description
DB924-GRY	Lyon hardware on Designer Grey display board, 16"W x 11"H

Finishes			
			
AB Brushed Antique Brass	BG Brushed Gold	BLK Matte Black	BNBDL Brushed Pewter

							
DACM Gun Metal	DBAC Brushed Oil Rubbed Bronze	NI Polished Nickel	ORB Dark Bronze	PC Polished Chrome	SBZ Satin Bronze	SIM Distressed Antique Silver	SN Satin Nickel



Knobs	Description	Overall Length	Width at Center	Projection	Hand Space	Foot Width	Foot Length	Inner Box	Price Code
972S	small square knob	7/8"	7/8"	1"	13/16"	7/16"	7/16"	30	[D]
972	medium square knob	1-1/8"	1-1/8"	1"	13/16"	1/2"	1/2"	30	[E]
972L	large square knob	1-1/4"	1-1/4"	1"	13/16"	9/16"	9/16"	20	[F]

Pulls	Center-to-Center	Overall Length	Width at Center	Projection	Hand Space	Foot Width	Foot Length	Inner Box	Price Code
972-96	96 mm (3-3/4") CC	4-1/2"	1/2"	1-1/16"	13/16"	1"	3/4"	10	[G]
972-128	128 mm (5-1/16") CC	5-13/16"	1/2"	1-1/16"	13/16"	1"	3/4"	10	[H]
972-160	160 mm (6-5/16") CC	7-1/16"	1/2"	1-1/16"	13/16"	1"	3/4"	10	[J]
972-224	224 mm (8-13/16") CC	9-3/4"	1/2"	1-1/16"	13/16"	1"	3/4"	15	[J]
972-305	305 mm (12") CC	12-3/4"	1/2"	1-1/16"	13/16"	1"	3/4"	10	[K]
972-12	12" CC appl. handle	13"	11/16"	1-1/2"	1-1/8"	1-3/8"	1"	5	[K]

Display Description
DB997-GRY Marlo hardware on Designer Grey display board, 16"W x 11"H

Finishes

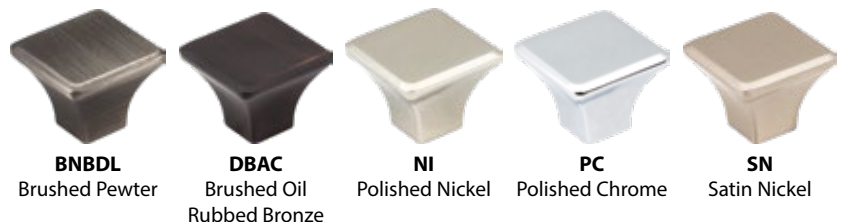

D786,648;
D790,316

PATENT



Knobs	Description	Overall Length	Width at Center	Projection	Hand Space	Foot Width	Foot Length	Inner Box	Price Code
445	round knob	1-1/4"	1-1/4"	1-1/8"	11/16"	11/16"	11/16"	10	[D]

Pulls	Center-to-Center	Overall Length	Width at Center	Projection	Hand Space	Foot Width	Foot Length	Inner Box	Price Code
445-96	96 mm (3-3/4") CC	4-3/8"	5/16"	1-5/16"	1"	5/8"	5/8"	10	[E]
445-128	128 mm (5-1/16") CC	5-5/8"	5/16"	1-1/2"	1-3/16"	5/8"	5/8"	10	[F]
445-160	160 mm (6-5/16") CC	6-7/8"	5/16"	1-1/2"	1-3/16"	5/8"	5/8"	10	[F]
445-192	192 mm (7-9/16") CC	8-3/16"	5/16"	1-1/2"	1-3/16"	5/8"	5/8"	10	[G]
445-224	224 mm (8-13/16") CC	9-7/16"	5/16"	1-1/2"	1-3/16"	5/8"	5/8"	10	[H]
445-305	305 mm (12") CC	12-11/16"	3/8"	1-1/2"	1-1/8"	11/16"	11/16"	10	[K]
445-12	12" CC appl. handle	13"	11/16"	2-1/8"	1-3/8"	1"	1"	1	[K]
445-18*	18" CC appl. handle	19"	11/16"	2-1/8"	1-3/8"	1"	1"	1	[K]

Display	Description
DB816-GRY	Marie hardware on Designer Grey display board, 16"W x 11"H



D956,510;
D968,192

PATENT

*18" appliance handles are packaged with 10-24 standard and 10-24 breakaway screws.



Shown in Satin Bronze

REGAL

The regal presence of Marie adds subtle grandeur to any cabinet with its elegant swooping lines and jewelry-like cuff detail. Adapted from a Jeffrey Alexander classic, this pull features a soft arch that discreetly adds extra hand clearance without being imposing—making it perfect for aging in place and ADA needs. Marie brings instant sophistication to any kitchen, bath, or closet.

Finishes



BNBDL
Brushed Pewter



DBAC
Brushed Oil
Rubbed Bronze



MB
Matte Black



PC
Polished Chrome



SBZ
Satin Bronze



SN
Satin Nickel



Pulls	Center-to-Center	Overall Length	Width at Center	Projection	Hand Space	Foot Width	Foot Length	Inner Box	Price Code
549-96	96 mm (3-3/4") CC	4-3/16"	9/16"	1-1/16"	13/16"	9/16"	5/8"	25	[E]
549-128	128 mm (5-1/16") CC	5-1/2"	9/16"	1-1/16"	13/16"	9/16"	5/8"	15	[E]
549-160	160 mm (6-5/16") CC	6-3/4"	9/16"	1-1/16"	13/16"	9/16"	5/8"	15	[F]
549-192	192 mm (7-9/16") CC	8"	9/16"	1-1/16"	13/16"	9/16"	5/8"	20	[F]
549-320	320 mm (12-5/8") CC	13-1/16"	9/16"	1-1/16"	13/16"	9/16"	5/8"	10	[K]

Display **Description**
 DB984-GRY Merrick hardware on Designer Grey display board, 16" W x 11" H



Shown in Brushed Pewter



Shown in Satin Bronze

COMFORTABLE

Subtle curves, a broad profile, and square feet make Merrick's simple strap pull anything but boring. A comfortable choice for various cabinet styles, this pull family's versatility makes it a popular preference.

Design Idea

When using two contrasting cabinet finishes, choose the same finish for knobs and pulls to tie everything together, or opt for various finishes that complement the cabinet color, adding more personality to a space.

Finishes



BNBDL
Brushed Pewter



DBAC
Brushed Oil
Rubbed Bronze



MB
Matte Black



PC
Polished Chrome



SBZ
Satin Bronze



SN
Satin Nickel



Knobs	Description	Overall Length	Width at Center	Projection	Hand Space	Foot Width	Foot Length	Inner Box	Price Code
1091	square knob	1-1/4"	1-1/4"	1"	5/8"	13/16"	13/16"	20	[E]

Pulls	Center-to-Center	Overall Length	Width at Center	Projection	Hand Space	Foot Width	Foot Length	Inner Box	Price Code
1092	96 mm (3-3/4") CC	4-1/4"	5/8"	1-1/16"	13/16"	1/2"	1/2"	20	[F]
1092-128	128 mm (5-1/16") CC	5-9/16"	5/8"	1-1/16"	13/16"	1/2"	1/2"	25	[G]
1092-160	160 mm (6-5/16") CC	6-13/16"	5/8"	1-1/16"	13/16"	1/2"	1/2"	20	[H]
1092-12	12" CC appl. handle	12-3/4"	7/8"	1-3/8"	1"	13/16"	13/16"	5	[K]

Display	Description
DB988-GRY	Milan 1 hardware on Designer Grey display board, 16" W x 11" H



CHARISMATIC

Charismatic and fashionable, the soft square design of Milan 1 has matured from a daring new shape to a timeless classic. The simple stepped square accents and the availability of an appliance pull make this collection a go-to for a variety of cabinet styles.



Shown in Gun Metal

Finishes



AB
Brushed
Antique Brass



AEM
Lightly Distressed
Antique Brass



BNBDL
Brushed Pewter



DACM
Gun Metal



DBAC
Brushed Oil
Rubbed Bronze



MB
Matte Black



PC
Polished Chrome



SN
Satin Nickel



Knobs	Description	Overall Length	Width at Center	Projection	Hand Space	Foot Width	Foot Length	Inner Box	Price Code
81021	16 mm (5/8") CC knob	1-9/16"	7/8"	3/4"	5/8"	1/4"	7/8"	30	[D]

Pulls	Center-to-Center	Overall Length	Width at Center	Projection	Hand Space	Foot Width	Foot Length	Inner Box	Price Code
80152-96	96 mm (3-3/4") CC	5-9/16"	3/4"	1"	13/16"	15/16"	1-1/8"	20	[G]
80152-128	128 mm (5-1/16") CC	6-13/16"	3/4"	1"	13/16"	15/16"	1-1/8"	20	[H]
80152-160	160 mm (6-5/16") CC	8-1/16"	3/4"	1-1/8"	1"	15/16"	1-5/16"	15	[H]

Display	Description
DB929-GRY	Mirada hardware on Designer Grey display board, 16"W x 11"H



Shown in Matte Black

ADVENTUROUS

Be adventurous with the bold but somehow familiar strap pull of Mirada. Its broad vaulting strap mingled with a controlled rectangular foot and matching knob will doubtlessly make a statement.

Finishes



ABSB
Antique Brushed
Satin Brass

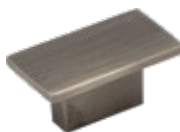

BNBDL
Brushed Pewter



DBAC
Brushed Oil
Rubbed Bronze



MB
Matte Black



PC
Polished Chrome



SN
Satin Nickel



Knobs	Description	Overall Length	Width at Center	Projection	Hand Space	Foot Width	Foot Length	Inner Box	Price Code
767	rectangle knob	1-1/4"	11/16"	1-1/16"	13/16"	1/2"	3/4"	25	[D]

Pulls	Center-to-Center	Overall Length	Width at Center	Projection	Hand Space	Foot Width	Foot Length	Inner Box	Price Code
767-96	96 mm (3-3/4") CC	5-1/16"	1/2"	1-1/16"	7/8"	11/16"	7/8"	15	[E]
767-128	128 mm (5-1/16") CC	6-5/16"	9/16"	1-1/8"	7/8"	3/4"	7/8"	10	[F]
767-160	160 mm (6-5/16") CC	7-9/16"	9/16"	1-1/8"	7/8"	3/4"	7/8"	10	[G]

Display	Description
DB815-GRY	Philip hardware on Designer Grey display board, 16"W x 11"H



Shown in Satin Nickel

PLAYFUL

The playful flare and soft lines of Philip's knob and pull create excitement and a bit of romance. The design options of this lively collection are matchless, making it a winning choice for any kitchen, bath, or closet.

Finishes



BG
Brushed Gold



BNBDL
Brushed Pewter



DBAC
Brushed Oil
Rubbed Bronze



MB
Matte Black



PC
Polished Chrome



SBZ
Satin Bronze



SN
Satin Nickel



Knobs	Description	Overall Length	Width at Center	Projection	Hand Space	Foot Width	Foot Length	Inner Box	Price Code
667S [†]	small round knob	1-1/16"	1-1/16"	1"	5/8"	13/16"	13/16"	20	[D]
667 [†]	medium round knob	1-1/4"	1-1/4"	1-1/8"	5/8"	13/16"	13/16"	20	[E]
667L [†]	large round knob	1-3/8"	1-3/8"	1-1/8"	11/16"	7/8"	7/8"	20	[F]

Pulls	Center-to-Center	Overall Length	Width at Center	Projection	Hand Space	Foot Width	Foot Length	Inner Box	Price Code
667-3 [†]	3" CC	3-7/16"	1/2"	1-3/16"	13/16"	1/2"	3/8"	20	[F]
667-96 [†]	96 mm (3-3/4") CC	4-3/16"	1/2"	1-3/16"	13/16"	1/2"	3/8"	20	[G]
667-128 [†]	128 mm (5-1/16") CC	5-1/2"	1/2"	1-3/16"	13/16"	1/2"	3/8"	15	[H]
667-160 [†]	160 mm (6-5/16") CC	6-3/4"	1/2"	1-3/16"	13/16"	1/2"	3/8"	10	[J]
667-224 [†]	224 mm (8-13/16") CC	9-1/4"	1/2"	1-3/16"	13/16"	1/2"	3/8"	10	[J]
667-305 [†]	305 mm (12") CC	12-9/16"	9/16"	1-1/4"	13/16"	9/16"	7/16"	10	[K]
667-12 [†]	12" CC appl. handle	12-13/16"	3/4"	1-7/8"	1-1/4"	3/4"	11/16"	5	[K]
667-18 ^{*†}	18" CC appl. handle	18-13/16"	3/4"	1-15/16"	1-1/4"	3/4"	11/16"	5	[K]

Finishes



These products are being retired. Check availability online or call for products marked with "†"

*18" appliance handles are packaged with 10-24 standard and 10-24 breakaway screws.



847-96DBAC



847-160SN



847-160MB



847-128PC



847-128BNBDL

Pulls	Center-to-Center	Overall Length	Width at Center	Projection	Hand Space	Foot Width	Foot Length	Inner Box	Price Code
847-96	96 mm (3-3/4") CC	5-9/16"	3/8"	7/8"	11/16"	5/8"	1-1/4"	25	[D]
847-128	128 mm (5-1/16") CC	6-13/16"	3/8"	7/8"	11/16"	5/8"	1-1/4"	25	[D]
847-160	160 mm (6-5/16") CC	8-1/16"	3/8"	7/8"	11/16"	5/8"	1-1/4"	25	[D]

Display	Description
DB985-GRY	Regan hardware on Designer Grey display board, 16"W x 11"H

Finishes



BNBDL
Brushed Pewter



DBAC
Brushed Oil Rubbed Bronze



MB
Matte Black



PC
Polished Chrome



SN
Satin Nickel



Knobs	Description	Overall Length	Width at Center	Projection	Hand Space	Foot Width	Foot Length	Inner Box	Price Code
141	square knob	1-1/4"	1-1/4"	1-1/8"	13/16"	3/4"	3/4"	20	[D]
141L	large square knob	1-3/4"	1-3/4"	1-1/8"	13/16"	3/4"	3/4"	10	[D]

Pulls	Center-to-Center	Overall Length	Width at Center	Projection	Hand Space	Foot Width	Foot Length	Inner Box	Price Code
141-96	96 mm (3-3/4") CC	4-5/8"	1-1/4"	1"	13/16"	1-1/4"	4-5/8"	10	[E]
141-128	128 mm (5-1/16") CC	5-7/8"	1-1/4"	1"	13/16"	1-1/4"	5-7/8"	10	[F]
141-160	160 mm (6-5/16") CC	7-1/8"	1-1/4"	1"	13/16"	1-1/4"	7-1/8"	10	[G]
141-192	192 mm (7-9/16") CC	8-3/8"	1-1/4"	1"	13/16"	1-1/4"	8-3/8"	10	[H]
141-305	305 mm (12") CC	12-7/8"	1-1/4"	1"	13/16"	1-1/4"	12-7/8"	5	[K]

Display	Description
DB818-GRY	Renzo hardware on Designer Grey display board, 16"W x 11"H

Finishes





DEBONAIR

Thoughtfully balanced lines blend with a boldly stepped profile in Renzo, resulting in a strong and debonair presence. Revitalizing the admired cup pull with its modern squared shape, this adaptable collection enhances the look of almost any cabinet style while adding functionality with its dual-hole mounting options.

Design Idea

Pair Renzo's cup pulls with Richard's standard pulls or appliance handles to create a modernistic and refined presence in any space. Find the Richard Collection on pages 94–95.



Shown in Satin Bronze

Center mount: use when the mounting holes are positioned in the center of the drawer front

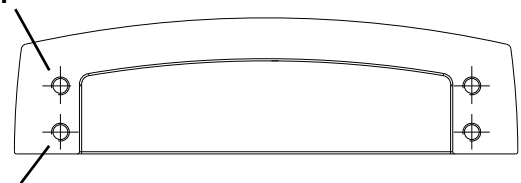

Lower mount: use when the mounting holes are positioned lower on the drawer front



Knobs	Description	Overall Length	Width at Center	Projection	Hand Space	Foot Width	Foot Length	Inner Box	Price Code
S6060	knob & backplate	1-1/4"	1-1/4"	1-7/16"	5/8"	1-1/4"	1-1/14"	25	[D]
Pulls	Center-to-Center	Overall Length	Width at Center	Projection	Hand Space	Foot Width	Foot Length	Inner Box	Price Code
Z260-3	3" CC	3-5/8"	1/2"	1-5/16"	1"	3/8"	9/16"	20	[D]
Z261-96	96 mm (3-3/4") CC	4-1/2"	9/16"	1-5/16"	1-1/8"	1/2"	9/16"	20	[D]
B812-96†	96 mm (3-3/4") CC backplate	6-1/8"	1-1/4"	1/8"	-	1-1/4"	6-1/8"	30	[E]
Z261-128	128 mm (5-1/16") CC	5-13/16"	5/8"	1-3/8"	1-1/8"	7/16"	9/16"	15	[G]
Z260-12	12" CC appl. handle	13-1/4"	1-1/8"	1-3/4"	1-3/16"	15/16"	7/8"	5	[K]

For more backplate options, see page 182.

These products are being retired. Check availability online or call for products marked with "†"

Finishes





Knobs	Description	Overall Length	Width at Center	Projection	Hand Space	Foot Width	Foot Length	Inner Box	Price Code
431	soft square knob	1-3/16"	1-3/16"	15/16"	9/16"	9/16"	9/16"	30	[D]
595	pyramid knob	1-1/4"	1-1/4"	7/8"	9/16"	5/8"	5/8"	20	[D]

Pulls	Center-to-Center	Overall Length	Width at Center	Projection	Hand Space	Foot Width	Foot Length	Inner Box	Price Code
798-96	96 mm (3-3/4") CC	5-1/2"	9/16"	1"	13/16"	9/16"	1"	10	[E]
798-128	128 mm (5-1/16") CC	6-3/4"	9/16"	1"	13/16"	9/16"	1"	10	[F]
798-160	160 mm (6-5/16") CC	8-1/16"	9/16"	1"	13/16"	9/16"	1"	10	[G]

Display	Description
DB990-GRY	Royce hardware on Designer Grey display board, 16"W x 11"H

Finishes

BNBDL Brushed Pewter
DBAC Brushed Oil Rubbed Bronze
PC Polished Chrome
SN Satin Nickel

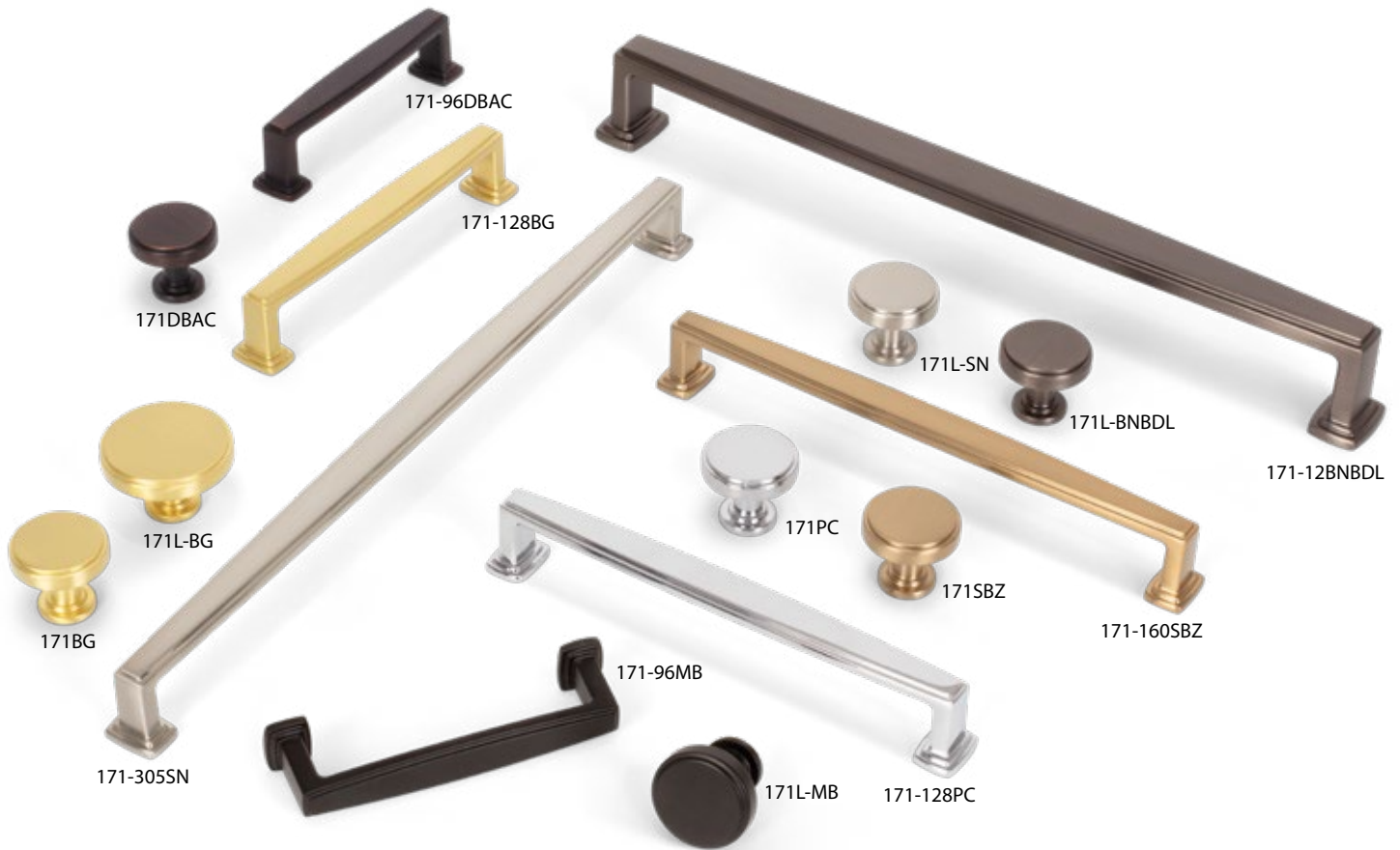

Knobs	Description	Overall Length	Width at Center	Projection	Hand Space	Foot Width	Foot Length	Inner Box	Price Code
171	round knob	1-1/4"	1-1/4"	1-1/8"	13/16"	3/4"	3/4"	20	[D]
171L	large round knob	1-3/4"	1-3/4"	1-1/8"	13/16"	3/4"	3/4"	10	[E]

Pulls	Center-to-Center	Overall Length	Width at Center	Projection	Hand Space	Foot Width	Foot Length	Inner Box	Price Code
171-96	96 mm (3-3/4") CC	4-3/8"	11/16"	1-1/8"	7/8"	13/16"	9/16"	10	[F]
171-128	128 mm (5-1/16") CC	5-5/8"	11/16"	1-1/8"	7/8"	13/16"	9/16"	10	[F]
171-160	160 mm (6-5/16") CC	6-7/8"	11/16"	1-1/8"	7/8"	13/16"	9/16"	10	[G]
171-192	192 mm (7-9/16") CC	8-1/8"	11/16"	1-1/8"	7/8"	13/16"	9/16"	10	[G]
171-305	305 mm (12") CC	12-5/8"	11/16"	1-1/8"	7/8"	13/16"	9/16"	10	[K]
171-12	12" CC appl. handle	12-13/16"	1"	1-5/8"	1-1/4"	1-1/8"	13/16"	5	[K]
171-18*	18" CC appl. handle	18-13/16"	1"	1-5/8"	1-1/4"	1-1/8"	13/16"	5	[K]

Display	Description
DB820-GRY	Richard hardware on Designer Grey display board, 16"W x 11" H



PATENT
Patent Pending

*18" appliance handles are packaged with 10-24 standard and 10-24 breakaway screws.



Shown in Satin Nickel

MODERNISTIC

The combination of a stately stepped profile and structured soft-square shape gives Richard an air of modernistic magnificence. Long balanced lines are echoed in both its pulls and knobs, adding charisma to any style cabinet it is coupled with.

Design Idea

Pair Richard's standard pulls or appliance handles with the Renzo cup pulls to create a modern, debonair presence in any space. Find the Renzo Collection on pages 90–91.

Finishes



BG
Brushed Gold



BNBDL
Brushed Pewter



DBAC
Brushed Oil
Rubbed Bronze



MB
Matte Black



PC
Polished Chrome



SBZ
Satin Bronze



SN
Satin Nickel

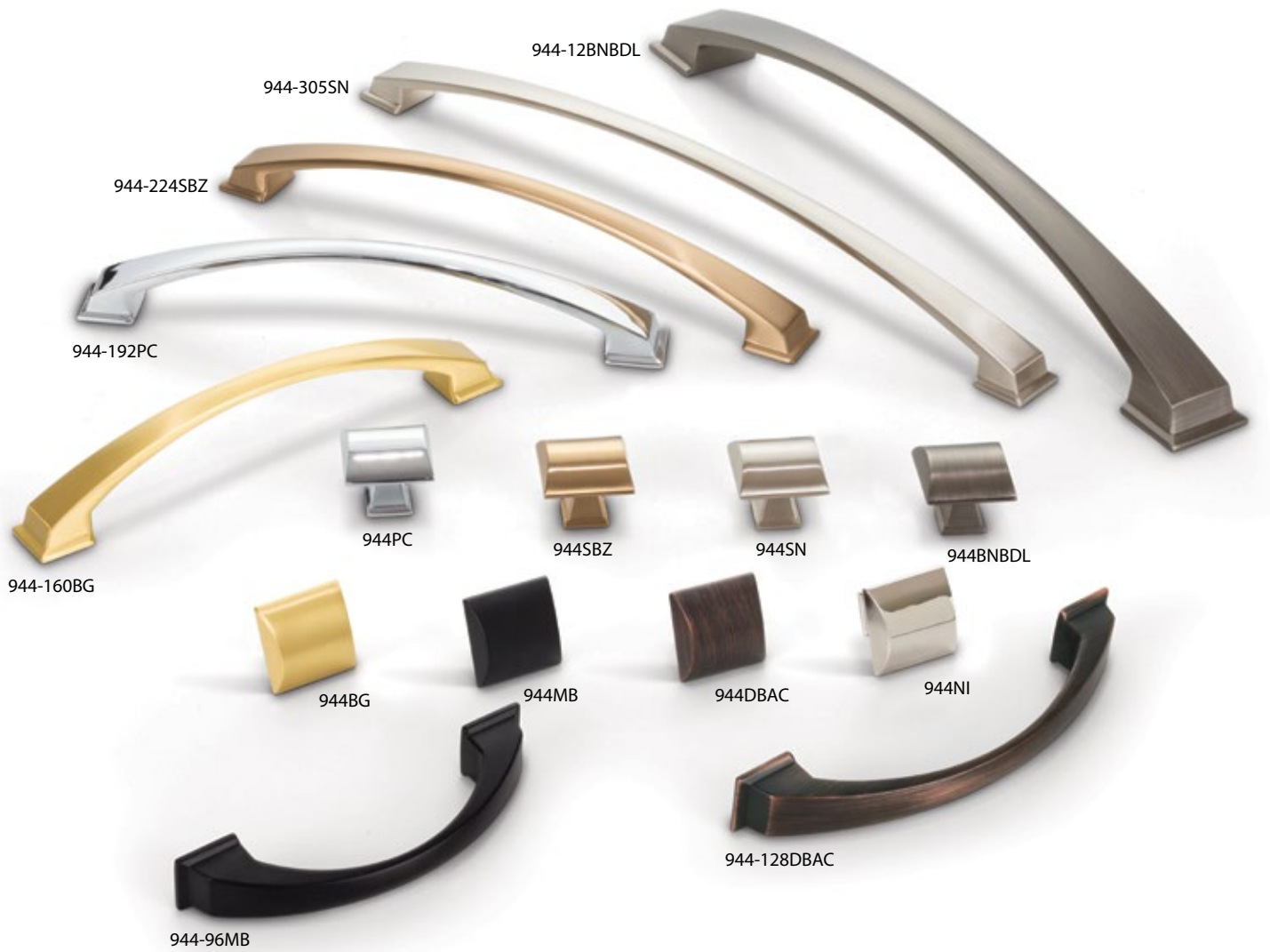

Knobs	Description	Overall Length	Width at Center	Projection	Hand Space	Foot Width	Foot Length	Inner Box	Price Code
944	square knob	1-1/4"	1-1/4"	1-1/8"	3/4"	5/8"	5/8"	20	[D]

Pulls	Center-to-Center	Overall Length	Width at Center	Projection	Hand Space	Foot Width	Foot Length	Inner Box	Price Code
944-96	96 mm (3-3/4") CC	4-15/16"	7/16"	1-7/16"	1-1/4"	13/16"	13/16"	10	[E]
944-128	128 mm (5-1/16") CC	6-1/4"	1/2"	1-7/16"	1-3/16"	7/8"	7/8"	10	[F]
944-160	160 mm (6-5/16") CC	7-1/2"	1/2"	1-7/16"	1-3/16"	7/8"	7/8"	10	[F]
944-192	192 mm (7-9/16") CC	8-3/4"	1/2"	1-7/16"	1-3/16"	15/16"	7/8"	10	[G]
944-224	224 mm (8-13/16") CC	10"	1/2"	1-1/2"	1-5/16"	15/16"	7/8"	15	[H]
944-305	305 mm (12") CC	13-3/16"	1/2"	1-9/16"	1-5/16"	15/16"	7/8"	10	[K]
944-12	12" CC appl. handle	13-5/8"	11/16"	1-7/8"	1-9/16"	1-3/8"	1-3/16"	5	[K]

Display	Description
DB812-GRY	Roman hardware on Designer Grey display board, 16"W x 11" H



Shown in Brushed Gold

INSPIRING

A flowing arch and strong structured foot make an inspiring and compelling combination for this knob and pull collection. The high arch of Roman's pull discreetly adds the additional height aging in place and ADA projects require while presenting a refined look.

Finishes



BG
Brushed Gold



BNBDL
Brushed Pewter



DBAC
Brushed Oil
Rubbed Bronze



MB
Matte Black



NI
Polished Nickel



PC
Polished Chrome



SBZ
Satin Bronze



SN
Satin Nickel



Knobs	Description	Overall Length	Width at Center	Projection	Hand Space	Foot Width	Foot Length	Inner Box	Price Code
431	soft square knob	1-3/16"	1-3/16"	15/16"	9/16"	9/16"	9/16"	30	[D]

Pulls	Center-to-Center	Overall Length	Width at Center	Projection	Hand Space	Foot Width	Foot Length	Inner Box	Price Code
4128	128 mm (5-1/16") CC	6-3/16"	5/8"	1-1/8"	7/8"	5/8"	3/4"	20	[F]
4160	160 mm (6-5/16") CC	8"	9/16"	1-3/16"	7/8"	11/16"	1"	20	[G]
4192	192 mm (7-9/16") CC	9-1/2"	11/16"	1-3/16"	7/8"	11/16"	1-1/4"	20	[H]
4288	288 mm (11-5/16") CC	14-7/16"	13/16"	1-1/4"	13/16"	13/16"	1-3/4"	10	[K]

Display Description

DB964-GRY Sonoma hardware on Designer Grey display board, 16"W x 11"H



Shown in Matte Black

SUBSTANTIAL

Sonoma's substantial profile, combined with a soft curve and coordinating sleek square knob, exudes understated elegance. Pair this collection with slab drawers and Shaker cabinets for an accomplished look.

Design Idea

Modernize white cabinets by adding contrasting black hardware.

Finishes



BNBDL
Brushed Pewter



DBAC
Brushed Oil
Rubbed Bronze



MB
Matte Black



PC
Polished Chrome



SN
Satin Nickel



Knobs	Description	Overall Length	Width at Center	Projection	Hand Space	Foot Width	Foot Length	Inner Box	Price Code
686	small clover knob	1-1/4"	1-1/8"	1-1/4"	1/2"	1/2"	1/2"	20	[D]
686L	large clover knob	1-1/2"	1-5/16"	1-7/16"	9/16"	5/8"	5/8"	15	[E]

Pulls	Center-to-Center	Overall Length	Width at Center	Projection	Hand Space	Foot Width	Foot Length	Inner Box	Price Code
686-96	96 mm (3-3/4") CC	4-1/8"	9/16"	1-1/2"	15/16"	9/16"	9/16"	15	[F]
686-128	128 mm (5-1/16") CC	5-3/8"	9/16"	1-1/2"	15/16"	9/16"	9/16"	15	[F]
686-160	160 mm (6-5/16") CC	6-11/16"	5/8"	1-1/2"	15/16"	9/16"	9/16"	10	[G]

Display	Description
DB825-GRY	Southerland hardware on Designer Grey display board, 16"W x 11"H



PATENT

Patent Pending



Shown in Satin Bronze

UNFORGETTABLE

Discover the unforgettable elegance of Southerland, an incomparable collection of knobs and pulls designed to add a touch of timeless beauty to any space. The pulls are available in three standard lengths, while the two sizes of knobs offer a delicate yet impactful embellishment. Transform any room with Southerland's clover-inspired design, where every detail tells the story of exquisite taste and charm.

Finishes



DBAC
Brushed Oil
Rubbed Bronze



MB
Matte Black



PC
Polished Chrome



SBZ
Satin Bronze



SN
Satin Nickel



Knobs	Description	Overall Length	Width at Center	Projection	Hand Space	Foot Width	Foot Length	Inner Box	Price Code
578T	T-knob	2-3/8"	11/16"	1-7/16"	7/8"	11/16"	1/2"	30	[E]

Pulls	Center-to-Center	Overall Length	Width at Center	Projection	Hand Space	Foot Width	Foot Length	Inner Box	Price Code
578-96	96 mm (3-3/4") CC	6-1/8"	7/16"	1-7/16"	7/8"	11/16"	1/2"	10	[F]
578-128	128 mm (5-1/16") CC	7-3/8"	7/16"	1-7/16"	7/8"	11/16"	1/2"	10	[F]
578-160	160 mm (6-5/16") CC	8-11/16"	7/16"	1-7/16"	7/8"	11/16"	1/2"	10	[G]

Display	Description
DB823-GRY	Spencer hardware on Designer Grey display board, 16"W x 11"H

Finishes





Shown in Matte Black

ICONIC

The pairing of a contemporary square foot with a crystal-clear acrylic bar in the Spencer Collection creates a captivatingly iconic finishing touch to any cabinet or furniture piece it adorns. This collection finds the perfect balance between opulence and approachable elegance.

Design Idea

Mix things up and pair Spencer with its sister collection Larkin, available in solid finishes and mixed finishes, to add an edgy touch to this iconically fashionable look. Find the Larkin Collection on pages 68–69.



Knobs	Description	Overall Length	Width at Center	Projection	Hand Space	Foot Width	Foot Length	Inner Box	Price Code
752-19	19 mm (3/4") CC knob	1-1/4"	3/4"	1-1/16"	-	3/4"	1-1/4"	25	[D]

Pulls	Center-to-Center	Overall Length	Width at Center	Projection	Hand Space	Foot Width	Foot Length	Inner Box	Price Code
752-96	96 mm (3-3/4") CC	4-1/2"	7/16"	1-3/16"	7/8"	3/4"	3/4"	20	[D]
752-128	128 mm (5-1/16") CC	5-13/16"	1/2"	1-3/16"	7/8"	3/4"	3/4"	10	[F]
752-160	160 mm (6-5/16") CC	7-1/16"	1/2"	1-3/16"	7/8"	3/4"	3/4"	10	[G]
752-192	192 mm (7-9/16") CC	8-5/16"	1/2"	1-3/16"	7/8"	3/4"	3/4"	10	[G]
752-224	224 mm (8-13/16") CC	9-9/16"	1/2"	1-3/16"	7/8"	3/4"	3/4"	10	[H]

Display	Description
DB810-GRY	Sullivan hardware on Designer Grey display board, 16"W x 11"H



POWERFUL

Reflecting the brawn of I-beams softened by gentle undercurves and tapered feet, Sullivan radiates a powerful yet serene presence. With a coordinating knob that echoes the pull's strong silhouette, this collection is adaptable to raised or flat panel cabinets.

Finishes



BNBDL
Brushed Pewter



DBAC
Brushed Oil
Rubbed Bronze



MB
Matte Black



PC
Polished Chrome



SN
Satin Nickel



Shown in Brushed Pewter



635-256MB



635-160PC



635-128BG



635-96SN



635-128SBZ



635-96BNBDL



635-32DBAC



635-32NI

Pulls	Center-to-Center	Overall Length	Width at Center	Projection	Hand Space	Foot Width	Foot Length	Inner Box	Price Code
635-32	32 mm (1-1/4") CC	2-1/4"	5/16"	1"	3/4"	5/16"	11/16"	30	[E]
635-96	96 mm (3-3/4") CC	4-3/4"	5/16"	1-1/16"	3/4"	5/16"	13/16"	25	[F]
635-128	128 mm (5-1/16") CC	5-7/8"	5/16"	1-1/16"	3/4"	5/16"	13/16"	20	[F]
635-160	160 mm (6-5/16") CC	7-1/2"	3/8"	1-1/16"	3/4"	3/8"	7/8"	10	[G]
635-256	256 mm (10-1/16") CC	11-7/16"	3/8"	1-1/8"	13/16"	3/8"	1"	20	[K]

Display Description
DB967-GRY Sutton hardware on Designer Grey display board, 16"W x 11"H



Shown in Brushed Gold

WARM

Sutton's square profile is softened with a warm and graceful curve that flows around the handgrip all the way down to its feet. The narrow design of these pulls can make both a fearless statement and whisper sophistication with the perfect finish choice.

Finishes



BG
Brushed Gold



BNBDL
Brushed Pewter



DBAC
Brushed Oil
Rubbed Bronze



MB
Matte Black



NI
Polished Nickel



PC
Polished Chrome



SBZ
Satin Bronze



SN
Satin Nickel



Knobs	Description	Overall Length	Width at Center	Projection	Hand Space	Foot Width	Foot Length	Inner Box	Price Code
602S	small square knob	1-1/4"	1-1/4"	1-3/16"	11/16"	9/16"	9/16"	30	[G]
602	large square knob	1-1/2"	1-1/2"	1-1/4"	11/16"	9/16"	9/16"	25	[G]

Pulls	Center-to-Center	Overall Length	Width at Center	Projection	Hand Space	Foot Width	Foot Length	Inner Box	Price Code
602-96	96 mm (3-3/4") CC	4-1/2"	1/2"	1-5/16"	3/4"	3/4"	3/4"	10	[H]
602-128	128 mm (5-1/16") CC	5-13/16"	1/2"	1-3/8"	3/4"	3/4"	3/4"	10	[J]
602-12	12" CC appl. handle	12-3/4"	1/2"	1-3/8"	3/4"	3/4"	3/4"	5	[K]

Finishes



Display Description

DB949-GRY Tahoe hardware on Designer Grey display board, 16"W x 11"H



D602,330;
D598,270

PATENT



Knobs	Description	Overall Length	Width at Center	Projection	Hand Space	Foot Width	Foot Length	Inner Box	Price Code
749†	T-knob	2-5/16"	13/16"	1-1/2"	11/16"	3/4"	3/4"	25	[D]
Pulls	Center-to-Center	Overall Length	Width at Center	Projection	Hand Space	Foot Width	Foot Length	Inner Box	Price Code
749-96B†	96 mm (3-3/4") CC	4-11/16"	13/16"	1-5/16"	1/2"	15/16"	15/16"	10	[F]
749-128B†	128 mm (5-1/16") CC	5-15/16"	13/16"	1-5/16"	1/2"	15/16"	15/16"	10	[F]
749-128†	128 mm (5-1/16") CC bail pull	5-15/16"	13/16"	1-5/16"	9/16"	15/16"	15/16"	10	[F]
749-160†	160 mm (6-5/16") CC bail pull	7-3/16"	13/16"	1-5/16"	9/16"	15/16"	15/16"	25	[H]
749-224†	224 mm (8-13/16") CC bail pull	9-3/4"	13/16"	1-5/16"	9/16"	15/16"	15/16"	25	[H]

Finishes



ABSB
Antique Brushed
Satin Brass



DACM
Gun Metal



DBAC
Brushed Oil
Rubbed Bronze



SIM
Distressed
Antique Silver

These products are being retired.
Check availability online or call for products marked with "†"



Knobs	Description	Overall Length	Width at Center	Projection	Hand Space	Foot Width	Foot Length	Inner Box	Price Code
658	round knob	1-1/4"	1-1/4"	1-5/16"	11/16"	7/8"	7/8"	20	[F]

Pulls	Center-to-Center	Overall Length	Width at Center	Projection	Hand Space	Foot Width	Foot Length	Inner Box	Price Code
658-96	96 mm (3-3/4") CC	4-1/2"	1/2"	1-5/16"	13/16"	3/4"	3/4"	20	[G]
658-128	128 mm (5-1/16") CC	5-13/16"	9/16"	1-5/16"	3/4"	3/4"	3/4"	15	[H]
658-160	160 mm (6-5/16") CC	7-1/16"	9/16"	1-3/8"	3/4"	3/4"	3/4"	10	[J]
658-192	192 mm (7-9/16") CC	8-3/8"	5/8"	1-3/8"	3/4"	13/16"	13/16"	15	[J]
658-224	224 mm (8-13/16") CC	9-7/8"	11/16"	1-1/2"	7/8"	7/8"	7/8"	15	[K]
658-12	12" CC appl. handle	13"	13/16"	2"	1-3/16"	1"	1"	5	[K]

Display	Description
DB994-GRY	Tiffany hardware on Designer Grey display board, 16"W x 11"H



PATENT D792,188



ELEGANT

Tiffany combines a classically elegant shape with a transitional twist for a look that is timeless. This pull and knob collection features matching step details throughout the hardware design, accompanied by flowing curves for a comfortable feel in your hand.



Shown in Brushed Gold

Finishes



BG
Brushed Gold



BNBDL
Brushed Pewter



DBAC
Brushed Oil
Rubbed Bronze



NI
Polished Nickel



PC
Polished Chrome



SBZ
Satin Bronze



SN
Satin Nickel



Knobs	Description	Overall Length	Width at Center	Projection	Hand Space	Foot Width	Foot Length	Inner Box	Price Code
678	geometric knob	1-1/4"	1-1/4"	1-3/16"	3/4"	3/4"	3/4"	20	[D]

Pulls	Center-to-Center	Overall Length	Width at Center	Projection	Hand Space	Foot Width	Foot Length	Inner Box	Price Code
678-96	96 mm (3-3/4") CC	5"	7/16"	1-1/16"	13/16"	13/16"	13/16"	10	[F]
678-128	128 mm (5-1/16") CC	6-1/4"	7/16"	1-1/16"	13/16"	13/16"	13/16"	10	[G]
678-160	160 mm (6-5/16") CC	7-1/2"	7/16"	1-1/16"	13/16"	13/16"	13/16"	10	[G]
678-18*	18" CC appl. handle	20-1/4"	3/4"	2"	1-5/8"	1-3/8"	1-3/8"	5	[K]

Display	Description
DB813-GRY	Wheeler hardware on Designer Grey display board, 16"W x 11"H

*18" appliance handles are packaged with 10-24 standard and 10-24 breakaway screws.



ENCHANTING

Controlled lines following a gentle contour result in an enchanting union of beauty and style. Wheeler offers meticulously styled pulls paired with a brilliantly angled octagon knob to dress up any kitchen, bathroom, or closet.



Shown in Matte Black

Finishes



BG
Brushed Gold



BNBDL
Brushed Pewter



DBAC
Brushed Oil
Rubbed Bronze



MB
Matte Black



PC
Polished Chrome



SBZ
Satin Bronze



SN
Satin Nickel



Knobs	Description	Overall Length	Width at Center	Projection	Hand Space	Foot Width	Foot Length	Inner Box	Price Code
905	square knob	1-1/4"	1-1/4"	1-3/16"	3/4"	5/16"	5/16"	20	[D]

Pulls	Center-to-Center	Overall Length	Width at Center	Projection	Hand Space	Foot Width	Foot Length	Inner Box	Price Code
905-96	96 mm (3-3/4") CC	5"	1/2"	1-3/8"	7/8"	5/16"	5/16"	10	[F]
905-128	128 mm (5-1/16") CC	6-1/4"	1/2"	1-3/8"	7/8"	5/16"	5/16"	10	[G]
905-160	160 mm (6-5/16") CC	7-1/2"	1/2"	1-3/8"	7/8"	5/16"	5/16"	10	[G]
905-192	192 mm (7-9/16") CC	8-3/4"	1/2"	1-3/8"	7/8"	5/16"	5/16"	10	[H]
905-305	305 mm (12") CC	13-1/4"	1/2"	1-3/8"	7/8"	5/16"	5/16"	10	[K]
905-12	12" CC appl. handle	14-1/2"	11/16"	1-15/16"	1-1/4"	7/16"	7/16"	5	[K]
905-18*	18" CC appl. handle	20-1/2"	11/16"	1-15/16"	1-1/4"	7/16"	7/16"	5	[K]

Display	Description
DB824-GRY	Whitlock hardware on Designer Grey display board, 16"W x 11"H

*18" appliance handles are packaged with 10-24 standard and 10-24 breakaway screws.



Shown in Matte Black

CAPTIVATING

Whitlock's captivating allure lies within its softened square shape, seamlessly uniting contemporary aesthetics with timeless charm. With an array of cabinet pull lengths and a coordinating knob, all available in six on-trend finishes, the versatility of this collection knows no bounds. Whitlock's powerful presence and winning design make it a flawless choice for those seeking to infuse their living spaces with elegance and modernity.

Finishes



BG
Brushed Gold



MB
Matte Black



PC
Polished Chrome



SBZ
Satin Bronze



SN
Satin Nickel



Knobs	Description	Overall Length	Width at Center	Projection	Hand Space	Foot Width	Foot Length	Inner Box	Price Code
293T	T-knob	2"	1/2"	1-1/4"	13/16"	5/16"	5/16"	10	[E]

Pulls	Center-to-Center	Overall Length	Width at Center	Projection	Hand Space	Foot Width	Foot Length	Inner Box	Price Code
293-96	96 mm (3-3/4") CC	5-1/16"	7/16"	1-1/4"	13/16"	5/16"	5/16"	10	[G]
293-128	128 mm (5-1/16") CC	6-5/16"	7/16"	1-1/4"	13/16"	5/16"	5/16"	10	[G]
293-160	160 mm (6-5/16") CC	7-9/16"	7/16"	1-1/4"	13/16"	5/16"	5/16"	10	[H]
293-192	192 mm (7-9/16") CC	8-13/16"	7/16"	1-1/4"	13/16"	5/16"	5/16"	10	[H]
293-224	224 mm (8-13/16") CC	10-1/16"	7/16"	1-1/4"	13/16"	5/16"	5/16"	10	[J]
293-305	305 mm (12") CC	13-1/4"	7/16"	1-1/4"	13/16"	5/16"	5/16"	10	[K]

Display Description
DB802-GRY Zane hardware on Designer Grey display board, 16"W x 11"H



Shown in Brushed Pewter

UNEXPECTED

The square bar pull structure with dashing strap detail of Zane is an unexpected and charming transformation from the basic bar or square bar pull. Available in extended pull lengths, this collection accents any modern or transitional design scheme with its clean lines and unique presence.

Finishes



BNBDL
Brushed Pewter



MB
Matte Black



NI
Polished Nickel



PC
Polished Chrome



SN
Satin Nickel



Belcastel 1 shown in Satin Nickel

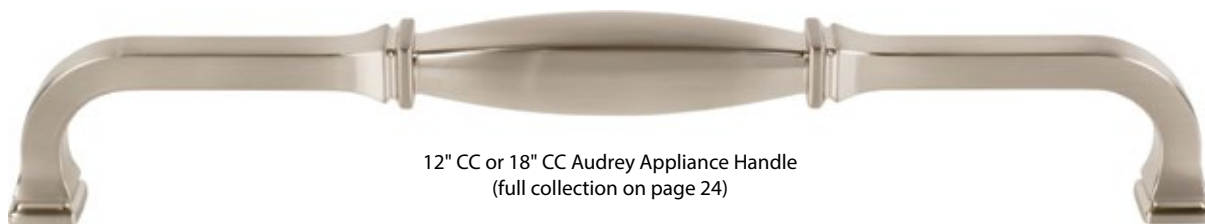

12" CC or 18" CC Audrey Appliance Handle
(full collection on page 24)

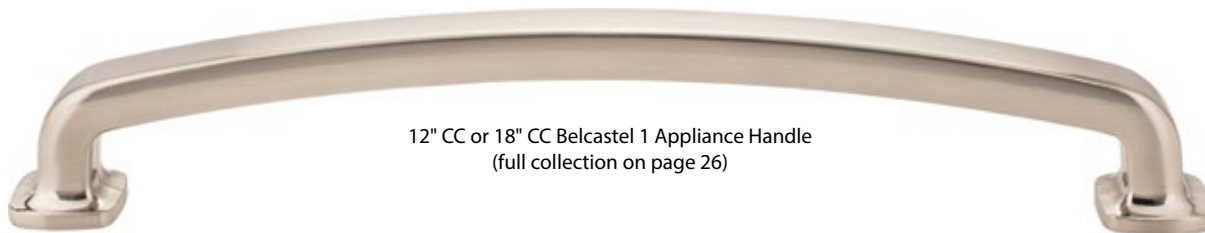

12" CC or 18" CC Belcastel 1 Appliance Handle
(full collection on page 26)



12" CC Bella Appliance Handle
(full collection on page 28)

Appl. Handle	Collection	Center-to-Center	Overall Length	Width at Center	Projection	Hand Space	Foot Width	Foot Length	Finishes Available	Page
278	Audrey	12" CC	12-5/8"	1"	2-1/4"	1-1/4"	3/4"	3/4"	BG, BNBDL, DBAC, MB, PC, SBZ, SN	24
278	Audrey	18" CC	18-3/4"	1"	2-1/4"	1-1/4"	3/4"	3/4"	BG, BNBDL, DBAC, MB, PC, SBZ, SN	24
MO6373	Belcastel 1	12" CC	13-1/4"	3/4"	2-5/16"	1-11/16"	1-1/8"	1-1/4"	ABM-D, BNBDL, DACM, DBAC, DMAC, MB, NI, PC, SBZ, SIM-D, SN	26
MO6373	Belcastel 1	18" CC	19-1/4"	3/4"	2-5/16"	1-11/16"	1-1/8"	1-1/4"	ABM-D, BNBDL, DACM, DBAC, DMAC, MB, NI, PC, SBZ, SIM-D, SN	26
818	Bella	12" CC	13-1/8"	1"	2"	1"	1-1/8"	1-1/8"	ABSB, BNBDL, DBAC, NI, SN	28

12" appliance handles are packaged with 8-32 standard and 8-32 breakaway screws.
18" appliance handles are packaged with 10-24 standard and 10-24 breakaway screws.



12" CC Bremen 1 Appliance Handle
(full collection on page 32)



12" CC Bremen 2 Appliance Handle
(full collection on page 34)



12" CC Chesapeake Appliance Handle
(full collection on page 42)



12" CC or 18" CC Cordova Appliance Handle
(full collection on page 43)



12" CC or 18" CC Delgado Appliance Handle
(full collection on page 44)

Appl. Handle	Collection	Center-to-Center	Overall Length	Width at Center	Projection	Hand Space	Foot Width	Foot Length	Finishes Available	Page
527	Bremen 1	12" CC	13-1/8"	3/4"	2-1/16"	1-1/2"	1-1/8"	1-1/8"	ABM-D, ABSB, BNBDL, DACM, DBAC, DMAC, NI, PC, SBZ, SIM, SN	32
537	Bremen 2	12" CC	12-11/16"	5/8"	1-5/8"	7/8"	11/16"	11/16"	ABSB, DACM, DBAC, DMAC, NI, SN	34
737	Chesapeake	12" CC	12-15/16"	1"	1-3/4"	1-1/8"	15/16"	15/16"	ABSB, BNBDL, DACM, DBAC, SIM, SN	42
Z281	Cordova	12" CC	12-3/4"	5/8"	2-1/16"	1-3/8"	1-9/16"	3/4"	ABSB, BNDL, DBAC, SN	43
Z281	Cordova	18" CC	18-3/4"	5/8"	2-1/16"	1-3/8"	1-9/16"	3/4"	ABSB, BNDL, DBAC, SN	43
519	Delgado	12" CC	12-1/2"	3/4"	1-1/2"	1"	3/4"	1/2"	ABSB, BNBDL, DBAC, NI, SN	44
519	Delgado	18" CC	18-1/2"	3/4"	1-1/2"	1"	3/4"	1/2"	ABSB, BNBDL, DBAC, NI, SN	44



Dominique shown in Satin Bronze



12" CC Delmar Appliance Handle
(full collection on page 45)



12" CC or 18" CC Dominique Appliance Handle
(full collection on page 46)

Appl. Handle	Collection	Center-to-Center	Overall Length	Width at Center	Projection	Hand Space	Foot Width	Foot Length	Finishes Available	Page
585	Delmar	12" CC	13-1/4"	1-1/4"	1-1/2"	1-1/4"	3/4"	7/8"	BNBDL, DACM, DBAC, DP, SN	45
845	Dominique	12" CC	15"	5/8"	1-7/8"	1-1/4"	1/2"	1/2"	BG, BNBDL, DBAC, MB, PC, SBZ, SN	46
845	Dominique	18" CC	21"	5/8"	1-7/8"	1-1/4"	1/2"	1/2"	BG, BNBDL, DBAC, MB, PC, SBZ, SN	46

12" appliance handles are packaged with 8-32 standard and 8-32 breakaway screws.
18" appliance handles are packaged with 10-24 standard and 10-24 breakaway screws.



12" CC Durham Appliance Handle
(full collection on page 48)



12" CC Ella Appliance Handle
(full collection on page 52)



12" CC Hudson Appliance Handle
(full collection on page 58)



12" CC Lafayette Appliance Handle
(full collection on page 70)

Appl. Handle	Collection	Center-to-Center	Overall Length	Width at Center	Projection	Hand Space	Foot Width	Foot Length	Finishes Available	Page
Z290	Durham	12" CC	13"	15/16"	2-1/8"	1-1/4"	1"	1"	ABSB, BNBDL, DACM, DBAC, MB, ORB, PC, SN	48
165	Ella	12" CC	13"	13/16"	1-5/8"	1-1/4"	1-1/4"	1"	BNBDL, DBAC, NI, PC, SN	52
650	Hudson	12" CC	13"	7/8"	1-9/16"	1-3/16"	1-3/8"	1"	BNBDL, DBAC, PC, SN	58
317	Lafayette	12" CC	12-15/16"	1-1/16"	2-3/16"	1-11/16"	7/8"	7/8"	ABSB, BNBDL, DBAC, SN	70



12" CC or 18" CC Larkin 1 Appliance Handle
(full collection on page 68)



12" CC or 18" CC Larkin 2 Appliance Handle
(full collection on page 68)



12" CC or 18" CC Larkin 3 (Knurled Center) Appliance Handle
(full collection on page 69)

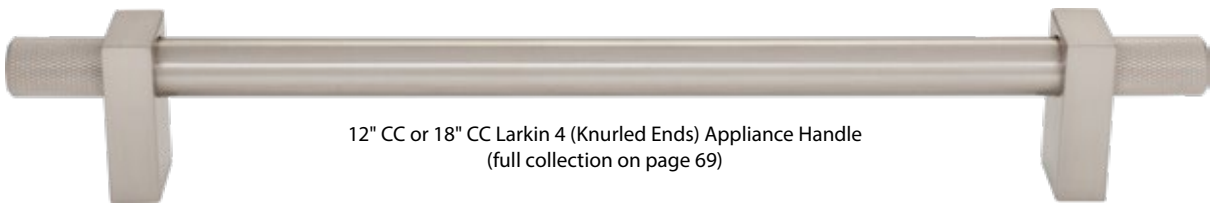

12" CC or 18" CC Larkin 4 (Knurled Ends) Appliance Handle
(full collection on page 69)

Appl. Handle	Collection	Center-to-Center	Overall Length	Width at Center	Projection	Hand Space	Foot Width	Foot Length	Finishes Available	Page
478	Larkin 1	12" CC	15-3/16	3/4"	2-3/16"	1-1/4"	1-1/8"	5/8"	BG, MB, PC, SBZ, SN	68
478	Larkin 1	18" CC	20-3/8"	3/4"	2-3/16"	1-1/4"	1-1/8"	5/8"	BG, MB, PC, SBZ, SN	68
478	Larkin 2	12" CC	15-3/16	3/4"	2-3/16"	1-1/4"	1-1/8"	5/8"	MBBG, MBPC, MBSBZ, MBSN	68
478	Larkin 2	18" CC	20-3/8"	3/4"	2-3/16"	1-1/4"	1-1/8"	5/8"	MBBG, MBPC, MBSBZ, MBSN	68
598	Larkin 3 (Knurled Center)	12" CC	14-3/8"	1-1/8"	2-3/16"	1-1/4"	5/8"	1-1/8"	BG, MB, SBZ, SN	69
598	Larkin 3 (Knurled Center)	18" CC	20-3/8"	1-1/8"	2-3/16"	1-1/4"	5/8"	1-1/8"	BG, MB, SBZ, SN	69
698	Larkin 4 (Knurled Ends)	12" CC	14-3/8"	1-1/8"	2-3/16"	1-1/4"	5/8"	1-1/8"	BG, MB, SBZ, SN	69
698	Larkin 4 (Knurled Ends)	18" CC	20-3/8"	1-1/8"	2-3/16"	1-1/4"	5/8"	1-1/8"	BG, MB, SBZ, SN	69

12" appliance handles are packaged with 8-32 standard and 8-32 breakaway screws.
18" appliance handles are packaged with 10-24 standard and 10-24 breakaway screws.



12" CC or 18" CC Loxley Appliance Handle
(full collection on page 74)

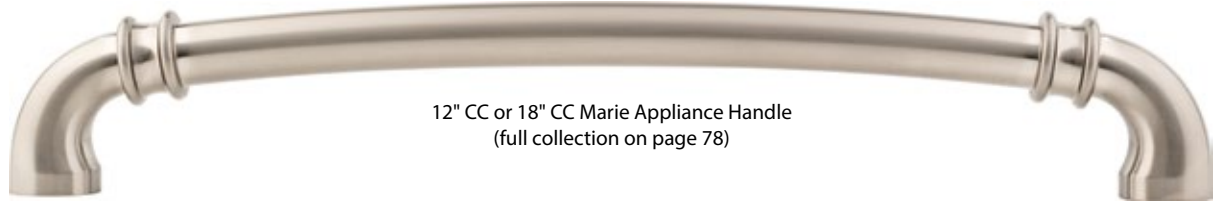

12" CC or 18" CC Marie Appliance Handle
(full collection on page 78)



12" CC Marlo Appliance Handle
(full collection on page 77)



12" CC Milan 1 Appliance Handle
(full collection on page 82)



12" CC Rhodes Appliance Handle
(full collection on page 92)

Appl. Handle	Collection	Center-to-Center	Overall Length	Width at Center	Projection	Hand Space	Foot Width	Foot Length	Finishes Available	Page
329	Loxley	12" CC	13-7/16"	11/16"	1-3/4"	1-1/4"	1"	1"	BG, BNBDL, DBAC, MB, PC, SBZ, SN	74
329	Loxley	18" CC	19-7/16"	11/16"	1-3/4"	1-1/4"	1"	1"	BG, BNBDL, DBAC, MB, PC, SBZ, SN	74
445	Marie	12" CC	13"	11/16"	2-1/8"	1-3/8"	1"	1"	BNBDL, DBAC, MB, PC, SBZ, SN	78
445	Marie	18" CC	19"	11/16"	2-1/8"	1-3/8"	1"	1"	BNBDL, DBAC, MB, PC, SBZ, SN	78
972	Marlo	12" CC	13"	11/16"	1-1/2"	1-1/8"	1-3/8"	1"	BNBDL, DBAC, NI, PC, SN	77
1092	Milan 1	12" CC	12-3/4"	7/8"	1-3/8"	1"	13/16"	13/16"	AB, AEM, BNBDL, DACM, DBAC, MB, PC, SN	82
Z260	Rhodes	12" CC	13-1/4"	1-1/8"	1-3/4"	1-3/16"	15/16"	7/8"	BNB, BNBDL, DACM, DBAC, SN	92



Richard showin in Satin Nickel



12" CC or 18" CC Richard Appliance Handle
(full collection on page 94)



12" CC Roman Appliance Handle
(full collection on page 96)



12" CC Tahoe Appliance Handle
(full collection on page 108)

Appl. Handle	Collection	Center-to-Center	Overall Length	Width at Center	Projection	Hand Space	Foot Width	Foot Length	Finishes Available	Page
171	Richard	12" CC	12-13/16"	1"	1-5/8"	1-1/4"	1-1/8"	13/16"	BG, BNBDL, DBAC, MB, PC, SBZ, SN	94
171	Richard	18" CC	18-13/16"	1"	1-5/8"	1-1/4"	1-1/8"	13/16"	BG, BNBDL, DBAC, MB, PC, SBZ, SN	94
944	Roman	12" CC	13-5/8"	11/16"	1-7/8"	1-9/16"	1-3/8"	1-3/16"	BG, BNBDL, DBAC, MB, NI, PC, SBZ, SN	96
602	Tahoe	12" CC	12-3/4"	1/2"	1-3/8"	3/4"	3/4"	3/4"	BLK, DMAC, SIM	108

12" appliance handles are packaged with 8-32 standard and 8-32 breakaway screws.
18" appliance handles are packaged with 10-24 standard and 10-24 breakaway screws.



12" CC Tiffany Appliance Handle
(full collection on page 110)



18" CC Wheeler Appliance Handle
(full collection on page 112)



12" CC or 18" CC Whitlock Appliance Handle
(full collection on page 114)

Appl. Handle	Collection	Center-to-Center	Overall Length	Width at Center	Projection	Hand Space	Foot Width	Foot Length	Finishes Available	Page
658	Tiffany	12" CC	13"	13/16"	2"	1-3/16"	1"	1"	BG, BNBDL, DBAC, NI, PC, SBZ, SN	110
678	Wheeler	18" CC	20-1/4"	3/4"	2"	1-5/8"	1-3/8"	1-3/8"	BG, BNBDL, DBAC, MB, PC, SBZ, SN	112
905	Whitlock	12" CC	14-1/2"	11/16"	1-15/16"	1-1/4"	7/16"	7/16"	BG, MB, PC, SBZ, SN	114
905	Whitlock	18" CC	20-1/2"	11/16"	1-15/16"	1-1/4"	7/16"	7/16"	BG, MB, PC, SBZ, SN	114



12" CC Gibson Appliance Handle
(full collection on page 144)



12" CC Walker 1 Appliance Handle
(full collection on page 176)

Appl. Handle	Collection	Center-to-Center	Overall Length	Width at Center	Projection	Hand Space	Foot Width	Foot Length	Finishes Available	Page
105	Gibson	12" CC	12-3/4"	3/4"	1-5/8"	1-1/4"	3/4"	3/4"	BG, BNBDL, MB, PC, SBZ, SN	144
827	Walker 1	12" CC	12-1/2"	1-1/8"	1-3/4"	1-1/4"	1-1/8"	1/2"	BG, BNBDL, MB, PC, SBZ, SN	176

The **essentials** and more, priced right



Stanton Collection on pages 166-167

40+ designs of knobs and pulls in the most popular styles and finishes

Complete line of solid steel and hollow stainless steel bar pulls available in the Naples Collection

Base Metal of cast zinc alloy, steel, aluminum or stainless steel for durability

Machine polished for consistent quality

Also ideal for the commercial, multi-family, retail, and builder markets

Limited Lifetime Warranty

William

See pages 178-179

New collection



Edgefield

New finish

ABG - Aluminum Brushed Gold

See pages 140-141

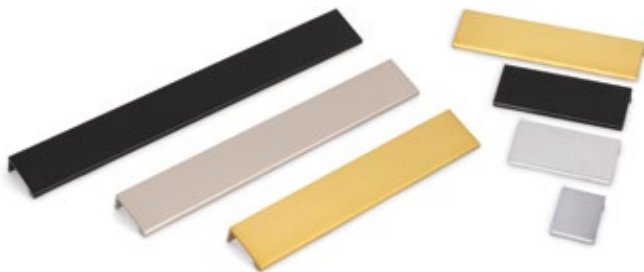

Gibson

New sizes

224 mm, 305 mm, and 12" pulls
1-5/8" large knob

See pages 144-145





These products are being retired. Check availability online or call for products marked with "†"

See collection pages for finish and size options



Aiden
page 130



Arcadia
page 132



Brenton
page 135



Calloway†
page 136



Calloway†
page 136



Capri
page 137



Capri
page 137



Capri
page 137



Cosgrove
page 138



Cypress
page 139



Florence
page 142



Gatsby
page 143



Gatsby
page 143



Gatsby
page 143



Gatsby/Kenner
page 143 & 150



Gibson
page 144



Glendale/Hammond
page 146 & 147



Hadly
page 148



Kingsport/Vienna
page 151 & 174



Kingsport
page 151



Kingsport
page 151



Kingsport
page 151



Lindos
page 154



Lindos
page 154



Madison
page 155



Merryville
page 156



Naples
page 160



Park
page 157



Seaver
page 162



Sedona
page 163



Slade
page 164



Syracuse
page 169



Thatcher
page 170



Verona
page 173



Vienna
page 174



Walker 1
page 176



Watervale
page 175



Westbury
page 180



William **NEW**
page 178



Zachary
page 181

All products, unless otherwise noted, are packaged with installation screws (8-32 standard and 8-32 breakaway screws).



Knobs	Description	Overall Length	Width at Center	Projection	Hand Space	Foot Width	Foot Length	Inner Box	Price Code
993	T-knob	1-5/8"	7/16"	1-1/16"	13/16"	1/2"	1/2"	30	[B]

Pulls	Center-to-Center	Overall Length	Width at Center	Projection	Hand Space	Foot Width	Foot Length	Inner Box	Price Code
993-3	3" CC	4-1/16"	1/2"	1-1/4"	7/8"	3/8"	11/16"	25	[D]
993-96	96 mm (3-3/4") CC	4-3/4"	9/16"	1-1/4"	7/8"	3/8"	11/16"	20	[D]
993-128	128 mm (5-1/16") CC	6-1/8"	5/8"	1-1/4"	7/8"	7/16"	11/16"	15	[E]

Display	Description
DBE1039-GRY	Aiden hardware on Designer Grey display board, 16"W x 11"H





Shown in Brushed Oil Rubbed Bronze

CHARMING

Charming and welcoming, Aiden offers a comfortable grip and ample hand clearance with its flowing arch profile. With its coordinating knob and extended sizes, this collection is a favorable choice for universal design needs.

Design Idea

For mudrooms, closets and bathrooms, pair cabinet knobs and pulls with Elements decorative hooks (see pages 219–222) in the same finish for a cohesive look with added organization.



Knobs	Description	Overall Length	Width at Center	Projection	Hand Space	Foot Width	Foot Length	Inner Box	Price Code
107	round knob	1-5/16"	1-5/16"	1"	5/8"	3/4"	3/4"	25	[C]

Pulls	Center-to-Center	Overall Length	Width at Center	Projection	Hand Space	Foot Width	Foot Length	Inner Box	Price Code
516	3" CC	5-7/16"	1/2"	1"	11/16"	13/16"	1-3/8"	25	[C]

Finishes





Pulls	Center-to-Center	Overall Length	Width at Center	Projection	Hand Space	Foot Width	Foot Length	Inner Box	Price Code
193-3	3" CC	3-1/4"	11/16"	1-1/8"	7/8"	3/4"	1/4"	15	[D]
193-96	96 mm (3-3/4") CC	4"	11/16"	1-1/8"	7/8"	3/4"	1/4"	15	[D]
193-4	4" CC	4-1/4"	11/16"	1-1/8"	7/8"	3/4"	1/4"	15	[E]
193-128	128 mm (5-1/16") CC	5-1/4"	11/16"	1-1/8"	7/8"	3/4"	1/4"	10	[E]
193-160	160 mm (6-5/16") CC	6-9/16"	11/16"	1-1/8"	7/8"	3/4"	1/4"	10	[F]

Display	Description
DBE1023-GRY	Asher hardware on Designer Grey display board, 16"W x 11"H

Finishes





Pulls	Center-to-Center	Overall Length	Width at Center	Projection	Hand Space	Foot Width	Foot Length	Inner Box	Price Code
308-128	128 mm (5-1/16") CC	5-9/16"	3/4"	15/16"	13/16"	3/8"	9/16"	25	[D]
406-128	128 mm (5-1/16") CC	6-9/16"	3/8"	1-1/4"	13/16"	5/16"	5/16"	20	[E]
745-128	128 mm (5-1/16") CC	5-11/16"	7/16"	1-3/16"	7/8"	5/8"	5/8"	20	[D]
776-128	128 mm (5-1/16") CC	5-11/16"	5/8"	1-3/16"	7/8"	5/8"	1/2"	20	[E]
976-128	128 mm (5-1/16") CC	6-3/16"	3/8"	1-1/16"	7/8"	1-3/16"	11/16"	20	[E]

Display	Description
DBE1018-GRY	Belfast hardware on Designer Grey display board, 16"W x 11"H

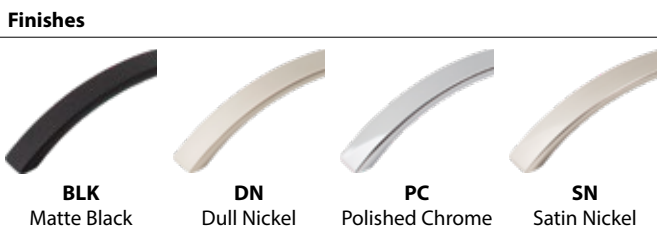



Knobs	Description	Overall Length	Width at Center	Projection	Hand Space	Foot Width	Foot Length	Inner Box	Price Code
239	round knob	1"	1"	1"	11/16"	3/8"	5/8"	30	[B]

Pulls	Center-to-Center	Overall Length	Width at Center	Projection	Hand Space	Foot Width	Foot Length	Inner Box	Price Code
239-96	96 mm (3-3/4") CC	4-5/16"	1/2"	1-1/8"	7/8"	1/2"	1/2"	15	[D]
239-128	128 mm (5-1/16") CC	5-9/16"	1/2"	1-1/8"	7/8"	1/2"	1/2"	15	[E]
239-160	160 mm (6-5/16") CC	6-13/16"	1/2"	1-1/8"	7/8"	1/2"	1/2"	15	[F]
239-192	192 mm (7-9/16") CC	8-1/16"	1/2"	1-1/8"	7/8"	1/2"	1/2"	10	[F]

Display **Description**
DBE1024-GRY Brenton hardware on Designer Grey display board, 16"W x 11"H

Finishes





Knobs	Description	Overall Length	Width at Center	Projection	Hand Space	Foot Width	Foot Length	Inner Box	Price Code
331†	small round knob	1-1/8"	1-1/8"	1"	3/4"	3/8"	3/8"	25	[B]
351†	small square knob	1-1/8"	1-1/8"	1"	3/4"	3/8"	3/8"	25	[B]
331L†	large round knob	1-1/4"	1-1/4"	1"	3/4"	3/8"	3/8"	25	[C]
351L†	large square knob	1-1/4"	1-1/4"	1"	3/4"	3/8"	3/8"	25	[C]

Pulls	Center-to-Center	Overall Length	Width at Center	Projection	Hand Space	Foot Width	Foot Length	Inner Box	Price Code
331-96†	96 mm (3-3/4") CC	4-1/2"	11/16"	1-1/16"	13/16"	3/8"	3/8"	15	[D]
351-96†	96 mm (3-3/4") CC	4-3/8"	11/16"	1-1/16"	13/16"	3/8"	3/8"	15	[D]
331-128†	128 mm (5-1/16") CC	5-3/4"	11/16"	1-1/16"	13/16"	3/8"	3/8"	10	[D]
351-128†	128 mm (5-1/16") CC	5-5/8"	11/16"	1-1/16"	13/16"	3/8"	3/8"	10	[E]

Finishes



These products are being retired. Check availability online or call for products marked with "†"



PATENT
D772,683
D729,036

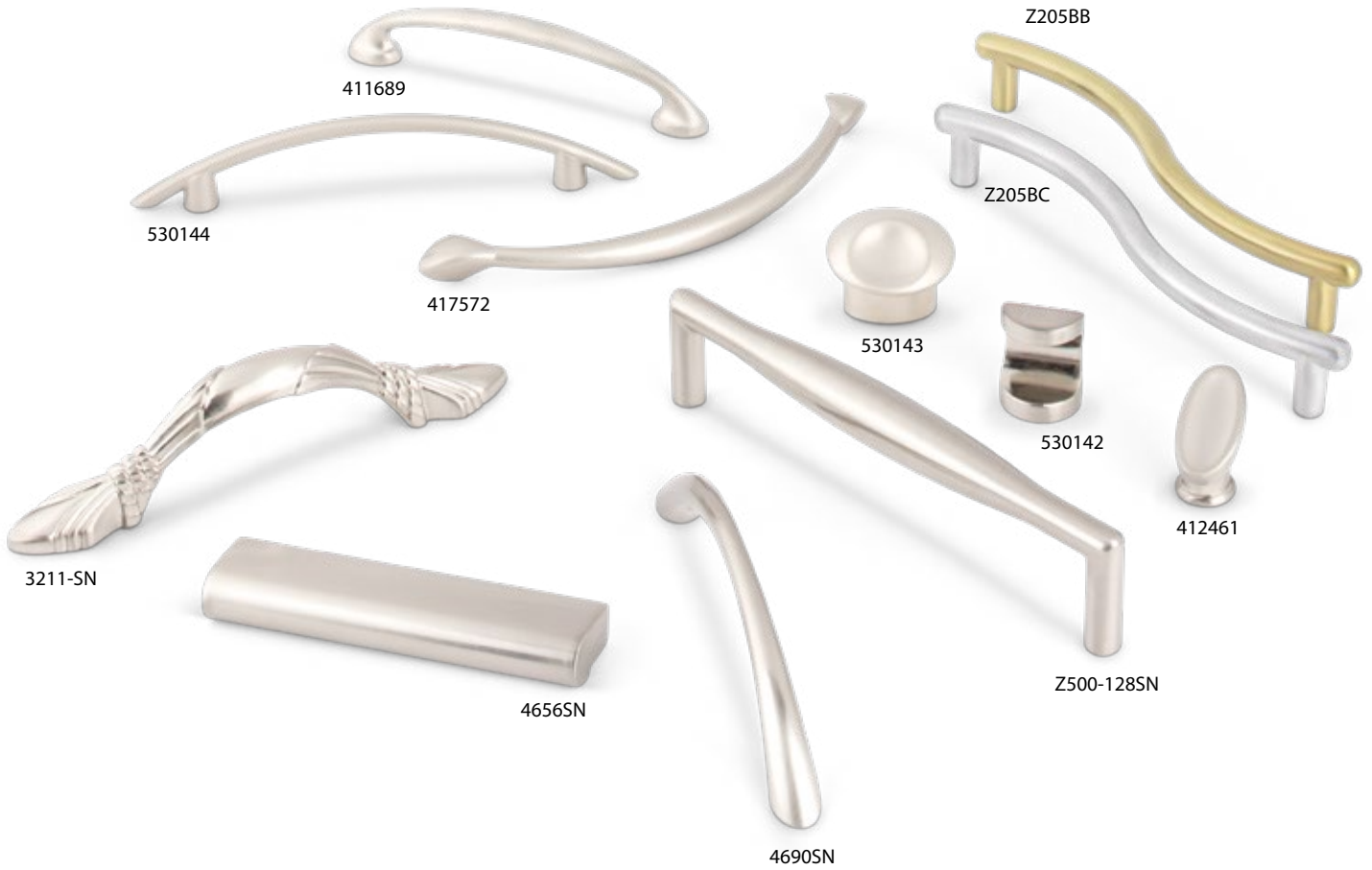

Knobs	Description	Overall Length	Width at Center	Projection	Hand Space	Foot Width	Foot Length	Inner Box	Price Code
412461	oval knob	1"	9/16"	15/16"	11/16"	9/16"	9/16"	50	[B]
530142	cylindrical knob	13/16"	13/16"	1"	5/8"	13/16"	13/16"	25	[B]
530143	concave round knob	1-1/4"	1-1/4"	7/8"	5/8"	3/8"	15/16"	25	[B]

Pulls	Center-to-Center	Overall Length	Width at Center	Projection	Hand Space	Foot Width	Foot Length	Inner Box	Price Code
3211	3" CC	4-15/16"	5/8"	1-1/16"	13/16"	11/16"	1-1/8"	25	[B]
4656	3" CC	3-3/8"	7/16"	13/16"	1/2"	3/8"	3-3/8"	25	[D]
411689*	96 mm (3-3/4") CC	4-3/8"	5/16"	7/8"	5/8"	7/16"	5/8"	50	[B]
4690	96 mm (3-3/4") CC	4-1/2"	1/4"	1-3/16"	15/16"	7/16"	1/2"	50	[B]
530144	96 mm (3-3/4") CC	5-1/4"	3/16"	15/16"	3/4"	3/8"	3/8"	50	[B]
417572	128 mm (5-1/16") CC	5-7/16"	3/8"	1"	11/16"	1/2"	7/16"	30	[C]
Z205	128 mm (5-1/16") CC	5-3/4"	5/16"	7/8"	9/16"	5/16"	5/16"	30	[D]
Z500-128	128 mm (5-1/16") CC	5-3/8"	9/16"	1-5/16"	3/4"	5/16"	5/16"	15	[F]

*M4 attachment screws included with this item

BB	Brushed Brass
BC	Brushed Chrome
DN	Dull Nickel
SN	Satin Nickel



Knobs	Description	Overall Length	Width at Center	Projection	Hand Space	Foot Width	Foot Length	Inner Box	Price Code
382	T-knob	1-1/2"	3/4"	1-1/8"	3/4"	1/2"	1/2"	25	[B]

Pulls	Center-to-Center	Overall Length	Width at Center	Projection	Hand Space	Foot Width	Foot Length	Inner Box	Price Code
382-96	96 mm (3-3/4") CC	6-1/2"	3/4"	1-1/16"	7/8"	1/2"	1-1/2"	15	[E]
382-128	128 mm (5-1/16") CC	7-3/4"	3/4"	1-1/16"	7/8"	1/2"	1-1/2"	10	[F]
382-160	160 mm (6-5/16") CC	9"	3/4"	1-1/16"	7/8"	1/2"	1-1/2"	10	[F]

Display	Description
DBE1025-GRY	Cosgrove hardware on Designer Grey display board, 16"W x 11"H

Finishes			
			
BNBDL Brushed Pewter	DBAC Brushed Oil Rubbed Bronze	PC Polished Chrome	SN Satin Nickel



Knobs	Description	Overall Length	Width at Center	Projection	Hand Space	Foot Width	Foot Length	Inner Box	Price Code
Z118	round knob	1-1/4"	1-1/4"	1-1/16"	11/16"	11/16"	11/16"	25	[A]

Pulls	Center-to-Center	Overall Length	Width at Center	Projection	Hand Space	Foot Width	Foot Length	Inner Box	Price Code
Z118-3	3" CC	3-7/16"	1/2"	1-1/8"	13/16"	5/16"	5/16"	20	[B]
Z118-96	96 mm (3-3/4") CC	4-1/16"	9/16"	1-1/4"	15/16"	3/8"	5/16"	20	[B]

Finishes



BNBDL
Brushed Pewter



DACM
Gun Metal



DBAC
Brushed Oil
Rubbed Bronze



SN
Satin Nickel

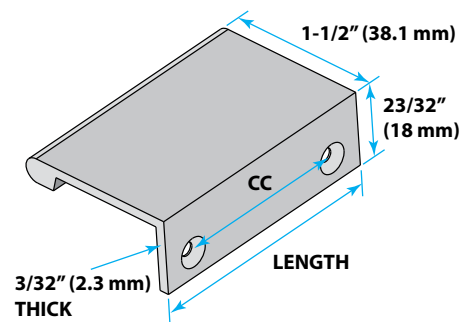
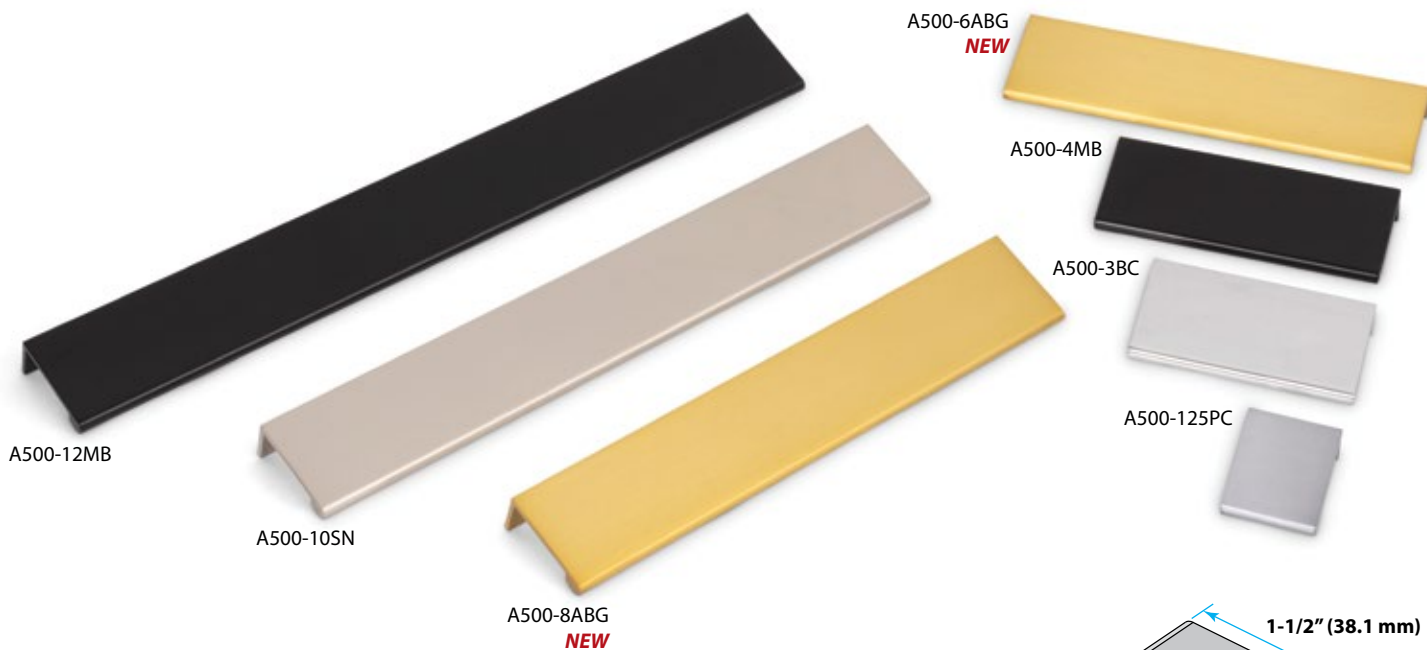

Pulls	Center-to-Center	Overall Length	Width at Center	Projection	Hand Space	Foot Width	Foot Length	Inner Box	Price Code
A500-125*	16 mm (5/8") CC tab pull	1-1/4"	11/16"	1-1/2"	-	23/32"	1-1/4"	50	[B]
A500-3*	60 mm (2-3/8") CC tab pull	3"	11/16"	1-1/2"	-	23/32"	3"	25	[D]
A500-4*	76 mm (3") CC tab pull	4"	11/16"	1-1/2"	-	23/32"	4"	25	[D]
A500-6*	127 mm (5") CC tab pull	6"	11/16"	1-1/2"	-	23/32"	6"	20	[E]
A500-8*	90 mm (3-9/16") CC tab pull (3 holes)	8"	11/16"	1-1/2"	-	23/32"	8"	20	[F]
A500-10*	114 mm (4-1/2") CC tab pull (3 holes)	10"	11/16"	1-1/2"	-	23/32"	10"	10	[G]
A500-12*	90 mm (3-9/16") CC tab pull (4 holes)	12"	11/16"	1-1/2"	-	23/32"	12"	10	[H]

*Wood screws included with all tab pulls

Display	Description
DBE1029-GRY	Edgefield hardware on Designer Grey display board, 16" W x 11" H

Finishes

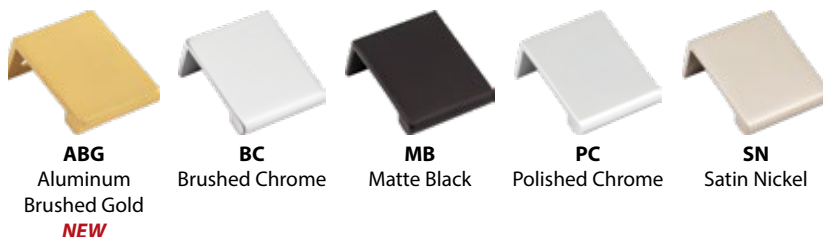



Shown in Matte Black

SLIM



Instantly upgrade kitchens with this slim and sleek collection of tab pulls from Elements. Edgefield features a thin design that is the ideal choice for contemporary homes.



Knobs	Description	Overall Length	Width at Center	Projection	Hand Space	Foot Width	Foot Length	Inner Box	Price Code
2980	round knob	1-1/4"	1-1/4"	1-1/8"	5/8"	1"	1"	20	[C]

Pulls	Center-to-Center	Overall Length	Width at Center	Projection	Hand Space	Foot Width	Foot Length	Inner Box	Price Code
2981	3" CC cup pull	3-11/16"	1-5/16"	1-1/8"	1-1/16"	1-5/16"	3-11/16"	20	[D]

Display	Description
DBE1012-GRY	Florence hardware on Designer Grey display board, 16"W x 11"H

Finishes								
								
AB Brushed Antique Brass	BNBDL Brushed Pewter	DACM Gun Metal	DBAC Brushed Oil Rubbed Bronze	MB Matte Black	ORB Dark Bronze	PC Polished Chrome	SBZ Satin Bronze	SN Satin Nickel



Knobs	Description	Overall Length	Width at Center	Projection	Hand Space	Foot Width	Foot Length	Inner Box	Price Code
3940	ringed dome knob	1-3/16"	1-3/16"	15/16"	5/8"	11/16"	11/16"	50	[A]
3950	mushroom knob	1-3/16"	1-3/16"	13/16"	7/16"	11/16"	11/16"	50	[A]
3960	button knob	1-1/4"	1-1/4"	1-1/16"	13/16"	3/4"	3/4"	25	[A]
3970	ringed flat knob	1-1/4"	1-1/4"	1-1/16"	3/4"	3/4"	3/4"	25	[A]

Pulls	Center-to-Center	Overall Length	Width at Center	Projection	Hand Space	Foot Width	Foot Length	Inner Box	Price Code
3108	3" CC pull	5-5/16"	11/16"	7/8"	5/8"	11/16"	1-1/4"	25	[B]
3208	3" CC pull	4-1/4"	5/16"	7/8"	5/8"	13/16"	7/8"	25	[A]
3308	3" CC pull	4-1/2"	7/16"	15/16"	9/16"	7/8"	7/8"	25	[B]

Finishes



*Matte Black finish only available in:
3960 knob
3970 knob
3108 pull

New sizes and knob

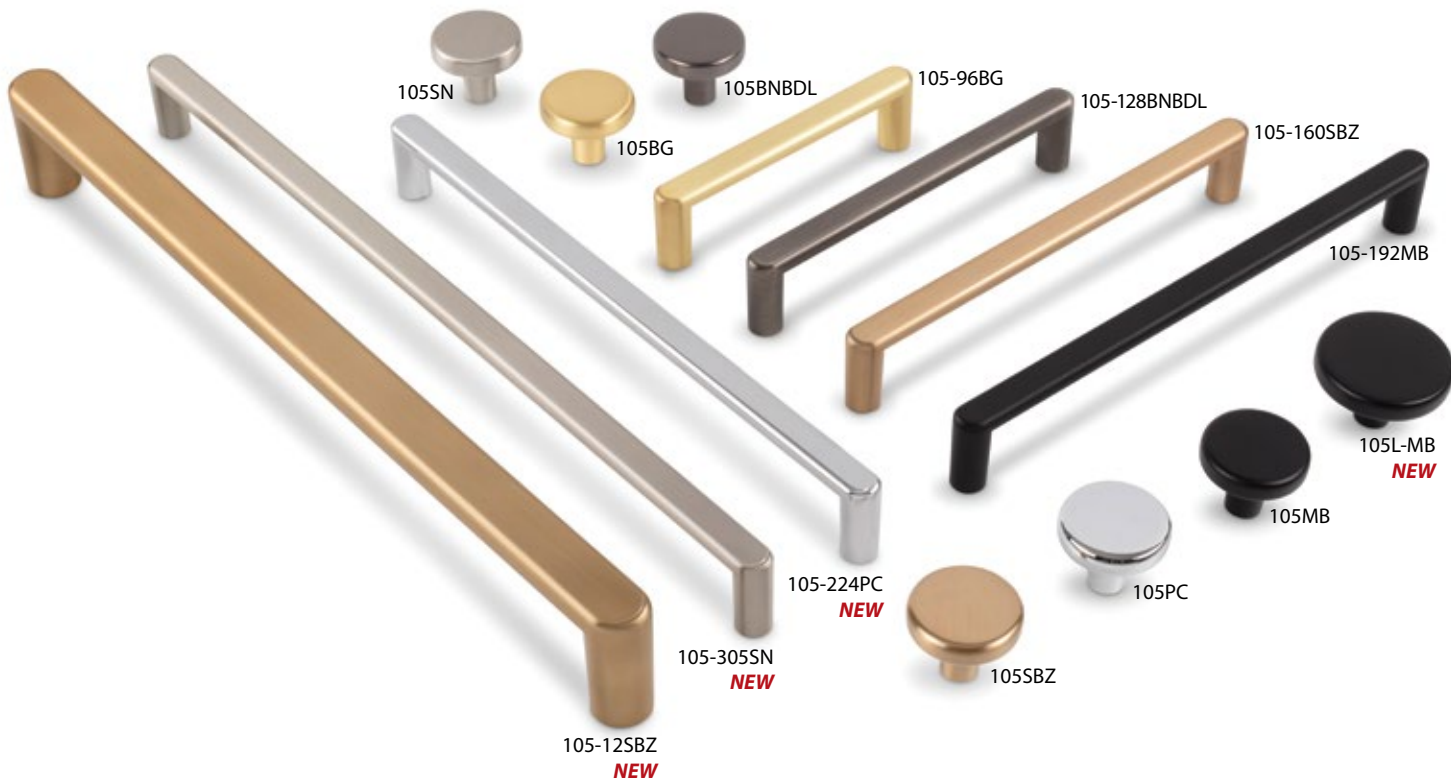

Knobs	Description	Overall Length	Width at Center	Projection	Hand Space	Foot Width	Foot Length	Inner Box	Price Code
105	small knob	1-1/4"	1-1/4"	1"	11/16"	7/16"	7/16"	10	[C]
105L NEW	large knob	1-5/8"	1-5/8"	1"	11/16"	7/16"	7/16"	10	[E]

Pulls	Center-to-Center	Overall Length	Width at Center	Projection	Hand Space	Foot Width	Foot Length	Inner Box	Price Code
105-96	96 mm (3-3/4") CC	4-1/4"	7/16"	1-1/8"	7/8"	7/16"	7/16"	10	[D]
105-128	128 mm (5-1/16") CC	5-1/2"	7/16"	1-1/8"	7/8"	7/16"	7/16"	10	[D]
105-160	160 mm (6-5/16") CC	6-3/4"	7/16"	1-1/8"	7/8"	7/16"	7/16"	10	[E]
105-192	192 mm (7-9/16") CC	8"	7/16"	1-1/8"	7/8"	7/16"	7/16"	10	[F]
105-224 NEW	224 mm (8-13/16")	9-5/16"	7/16"	1-1/8"	7/8"	7/16"	7/16"	10	[G]
105-305 NEW	305 mm (12") CC	12-1/2"	7/16"	1-1/8"	7/8"	7/16"	7/16"	10	[K]
105-12 NEW	12" CC appl. handle	12-3/4"	3/4"	1-5/8"	1-1/4"	3/4"	3/4"	1	[K]

Display	Description
DBE1046-GRY	Gibson hardware on Designer Grey display board, 16"W x 11"H

Finishes



BG Brushed Gold **BNBDL** Brushed Pewter **MB** Matte Black **PC** Polished Chrome **SBZ** Satin Bronze **SN** Satin Nickel



Shown in Brushed Pewter

HARMONIC

Gibson, with its clean, casual lines, brings an effortless, harmonic vibe to any contemporary or transitional space. A coordinating smooth and simplistic 1-1/4" diameter cabinet knob pairs melodiously with its cabinet pull. The standard pull features soft outer curves and straight lines that flow into cylindrical feet producing an easy-going feel. This closed-end bar pull collection is a crowd-pleaser.



Knobs	Description	Overall Length	Width at Center	Projection	Hand Space	Foot Width	Foot Length	Inner Box	Price Code
525	square knob	1-1/8"	1-1/16"	15/16"	9/16"	1/4"	1/4"	50	[C]

Pulls	Center-to-Center	Overall Length	Width at Center	Projection	Hand Space	Foot Width	Foot Length	Inner Box	Price Code
525-96	96 mm (3-3/4") CC	4-15/16"	1/4"	15/16"	13/16"	15/16"	13/16"	25	[D]

Display	Description
DBE1013-GRY	Glendale hardware on Designer Grey display board, 16"W x 11"H

Finishes





Knobs	Description	Overall Length	Width at Center	Projection	Hand Space	Foot Width	Foot Length	Inner Box	Price Code
525	square knob	1-1/8"	1-1/16"	15/16"	9/16"	1/4"	1/4"	50	[C]

Pulls	Center-to-Center	Overall Length	Width at Center	Projection	Hand Space	Foot Width	Foot Length	Inner Box	Price Code
937-3	3" CC	4-7/8"	3/8"	15/16"	3/4"	9/16"	1-1/8"	20	[B]
937-96	96 mm (3-3/4") CC	5-11/16"	3/8"	15/16"	3/4"	9/16"	1-1/16"	20	[D]

Display	Description
DBE1034-GRY	Hammond hardware on Designer Grey display board, 16"W x 11"H

Finishes

BNBDL Brushed Pewter
DBAC Brushed Oil Rubbed Bronze
MB Matte Black
PC Polished Chrome
SN Satin Nickel



Knobs	Description	Overall Length	Width at Center	Projection	Hand Space	Foot Width	Foot Length	Inner Box	Price Code
449	square knob	1"	1"	1"	3/4"	1/2"	1/2"	25	[C]

Pulls	Center-to-Center	Overall Length	Width at Center	Projection	Hand Space	Foot Width	Foot Length	Inner Box	Price Code
449-3	3" CC	4"	5/8"	1-1/8"	7/8"	1/2"	1/2"	15	[D]
449-96	96 mm (3-3/4") CC	4-3/4"	5/8"	1-1/8"	7/8"	1/2"	1/2"	15	[D]
449-128	128 mm (5-1/16") CC	6"	5/8"	1-1/8"	7/8"	1/2"	1/2"	10	[E]
449-160	160 mm (6-5/16") CC	7-1/4"	5/8"	1-1/8"	7/8"	1/2"	1/2"	10	[F]

Display	Description
DBE1036-GRY	Hadly hardware on Designer Grey display board, 16"W x 11"H



PATENT

D833,249
D833,252

Finishes

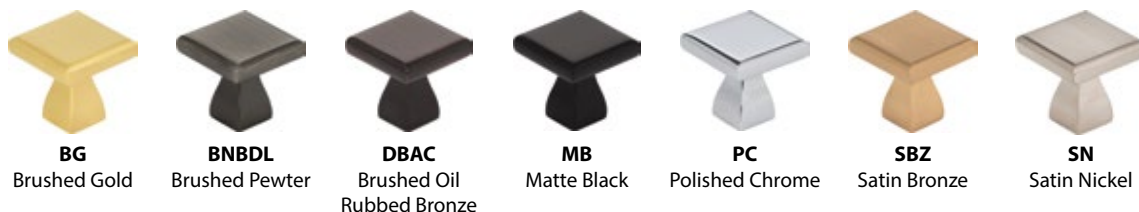



Shown in Matte Black

FUN

Hadly has quickly flourished into a crowd favorite with its fun and lively square silhouette. The clean lines, softened curves, strikingly sculpted flared feet, and variety of lengths and finishes of this knob and pull combination blend seamlessly with contemporary or transitional spaces.

Design Idea

Black and gold accents add so much personality to a predominantly white space. Don't be afraid to pair matte black hardware with gold accents to add pizzazz to any kitchen or bath.



Knobs	Description	Overall Length	Width at Center	Projection	Hand Space	Foot Width	Foot Length	Inner Box	Price Code
3970	round knob	1-1/4"	1-1/4"	1-1/16"	3/4"	3/4"	3/4"	25	[A]

Pulls	Center-to-Center	Overall Length	Width at Center	Projection	Hand Space	Foot Width	Foot Length	Inner Box	Price Code
254-3	3" CC	5"	3/16"	15/16"	11/16"	11/16"	1-1/8"	20	[B]
254-96	96 mm (3-3/4") CC	5-3/4"	1/4"	15/16"	11/16"	11/16"	1-1/8"	20	[D]

Display	Description
DBE1032-GRY	Kenner hardware on Designer Grey display board, 16" W x 11" H





Knobs	Description	Overall Length	Width at Center	Projection	Hand Space	Foot Width	Foot Length	Inner Box	Price Code
202	ringed knob	1-1/4"	1-1/4"	1"	5/8"	3/8"	3/8"	50	[A]
875	ringed button knob	1-5/16"	1-5/16"	11/16"	9/16"	5/16"	5/16"	100	[A]
878	button knob	1-3/16"	1-3/16"	1"	5/8"	11/16"	11/16"	50	[B]
WK150	dome knob	1-1/4"	1-1/4"	7/8"	9/16"	1/4"	1/4"	100	[A]

Pulls	Center-to-Center	Overall Length	Width at Center	Projection	Hand Space	Foot Width	Foot Length	Inner Box	Price Code
840	3" CC	4-13/16"	5/16"	13/16"	5/8"	3/8"	7/16"	50	[A]
1018	3" CC	4-7/16"	7/16"	1"	11/16"	5/16"	5/16"	25	[A]
3208	3" CC	4-1/4"	5/16"	7/8"	5/8"	13/16"	7/8"	25	[A]
4655	128 mm (5-1/16") CC	6-1/4"	3/16"	1-1/4"	1-1/16"	7/16"	13/16"	25	[D]
CH3503 [‡]	3-1/2" CC	4-3/4"	2-3/16"	9/16"	1-9/16"	1-5/16"	1-5/16"	25	[D]
WP150 [‡]	3" CC	4-5/16"	2-15/16"	1/2"	7/8"	2-15/16"	4-5/16"	25	[D]
WB150*	4-11/16" CC backplate for knob	6-1/16"	7/8"	1/8"	-	1"	6-1/16"	50	[B]

[‡]This pull has posts that needs an easy extra step to achieve a flush mount. Once you have drilled your hole with a 3/16" bit, use a 1/4" bit to expand the hole on the face of the door/drawer front to seat the post of the pull.

*Two attachment nails included with WB150 backplate

AB	Brushed Antique Brass
AE	Antique Brass



645-224SN

645-192PC

645-160MB

645-320MB

645-128SN

645-96PC

Pulls	Center-to-Center	Overall Length	Width at Center	Projection	Hand Space	Foot Width	Foot Length	Inner Box	Price Code
645-96	96 mm (3-3/4") CC	4-1/4"	1/2"	1-3/8"	7/8"	5/16"	15/16"	10	[E]
645-128	128 mm (5-1/16") CC	5-9/16"	1/2"	1-3/8"	7/8"	5/16"	15/16"	10	[F]
645-160	160 mm (6-5/16")	6-13/16"	1/2"	1-3/8"	7/8"	5/16"	15/16"	10	[F]
645-192	192 mm (7-9/16")	8-1/16"	1/2"	1-3/8"	7/8"	5/16"	15/16"	10	[G]
645-224	224 mm (8-13/16")	9-5/16"	1/2"	1-3/8"	7/8"	5/16"	15/16"	10	[G]
645-320	320 mm (12-5/8") CC	13-1/16"	1/2"	1-3/8"	7/8"	5/16"	15/16"	10	[H]

Display Description

DBE1044-GRY Knox hardware on Designer Grey display board, 16"W x 11"H

Finishes



MB
Matte Black



PC
Polished Chrome



SN
Satin Nickel



Shown in Matte Black

SUBTLE

A subtle reflection of a warded lock key, Knox pairs leading lines and intentional curves for a simple yet distinctive look. This closed-ended bar pull series offers a generous 1" hand clearance for an aesthetically pleasing option for aging in place and ADA projects.

Design Idea

When choosing hardware, think about how often the drawers or doors are used, as well as who the user is. Longer pulls and pulls with a larger hand clearance are easier to grab, especially for users with limited hand mobility.



Knobs	Description	Overall Length	Width at Center	Projection	Hand Space	Foot Width	Foot Length	Inner Box	Price Code
Z115	round knob	1-1/4"	1-1/4"	1-1/8"	3/4"	3/4"	3/4"	25	[B]
Z115L	oval knob	1-3/8"	13/16"	1-1/8"	11/16"	9/16"	9/16"	25	[B]

Pulls	Center-to-Center	Overall Length	Width at Center	Projection	Hand Space	Foot Width	Foot Length	Inner Box	Price Code
Z115-96	96 mm (3-3/4") CC	4-5/16"	5/8"	1-1/8"	15/16"	5/16"	7/16"	20	[C]
Z115-128	128 mm (5-1/16") CC	5-7/16"	11/16"	1-1/8"	15/16"	3/8"	7/16"	15	[G]

Display	Description
DBE1020-GRY	Lindos hardware on Designer Grey display board, 16" W x 11" H

Finishes





Knobs	Description	Overall Length	Width at Center	Projection	Hand Space	Foot Width	Foot Length	Inner Box	Price Code
3910	round knob	1-3/16"	1-3/16"	1-1/8"	5/8"	11/16"	11/16"	30	[B]

Pulls	Center-to-Center	Overall Length	Width at Center	Projection	Hand Space	Foot Width	Foot Length	Inner Box	Price Code
Z259-3	3" CC	3-3/8"	3/8"	1-1/8"	3/4"	3/8"	3/8"	50	[B]

Display	Description
DBE1040-GRY	Madison hardware on Designer Grey display board, 16"W x 11"H

Finishes





Knobs	Description	Overall Length	Width at Center	Projection	Hand Space	Foot Width	Foot Length	Inner Box	Price Code
897	small oval knob	1-1/8"	3/4"	1-1/4"	7/8"	9/16"	9/16"	20	[B]
897L	large oval knob	1-1/4"	13/16"	1-1/4"	7/8"	5/8"	5/8"	20	[B]

Pulls	Center-to-Center	Overall Length	Width at Center	Projection	Hand Space	Foot Width	Foot Length	Inner Box	Price Code
897-3	3" CC	5-1/8"	1/2"	1"	3/4"	9/16"	1-3/16"	20	[B]

Display	Description
DBE1033-GRY	Merryville hardware on Designer Grey display board, 16"W x 11"H

Finishes





Knobs	Description	Overall Length	Width at Center	Projection	Hand Space	Foot Width	Foot Length	Inner Box	Price Code
183	square knob	1"	1"	1-1/8"	13/16"	3/8"	1/2"	25	[C]

Pulls	Center-to-Center	Overall Length	Width at Center	Projection	Hand Space	Foot Width	Foot Length	Inner Box	Price Code
183-3	3" CC	3-3/4"	3/4"	1-1/8"	7/8"	5/16"	1/2"	15	[D]
183-96	96 mm (3-3/4") CC	4-1/2"	3/4"	1-1/8"	7/8"	5/16"	1/2"	15	[D]

Display	Description
DBE1038-GRY	Park hardware on Designer Grey display board, 16"W x 11"H

Finishes

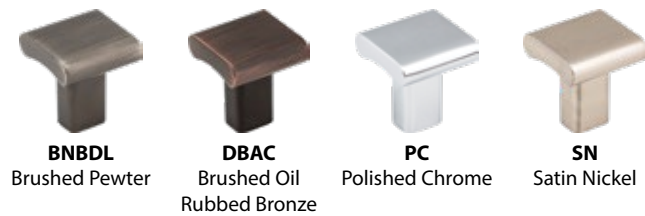

 D833,250
PATENT D833,253



EVERLASTING

This cylindrical and classic bar pull from Naples is an everlasting design, perfect for a variety of cabinet styles. Use this straight-line bar pull collection from Elements to seamlessly update cabinets and furniture, bringing a modern look to any room. Available in solid steel as well as hollow stainless steel, in a variety of lengths and finishes.



Shown in Matte Black

Naples



Shown in Brushed Gold

Design Idea

Coordinate knobs and pulls with other elements in the kitchen like faucets, door hardware, and lighting to create a cohesive look.





Knobs	Description	Overall Length	Width at Center	Projection	Hand Space	Foot Width	Foot Length	Inner Box	Price Code
40	T-knob	1-9/16"	1/2"	1-3/8"	7/8"	3/8"	3/8"	30	[B]
Pulls	Center-to-Center	Overall Length	Width at Center	Projection	Hand Space	Foot Width	Foot Length	Inner Box	Price Code
136	3" CC	5-3/8"	1/2"	1-3/8"	7/8"	3/8"	3/8"	10	[C]
156	96 mm (3-3/4") CC	6-1/8"	1/2"	1-3/8"	7/8"	3/8"	3/8"	10	[D]
176	128 mm (5-1/16") CC	6-15/16"	1/2"	1-3/8"	7/8"	3/8"	3/8"	10	[D]
206	128 mm (5-1/16") CC	8-1/8"	1/2"	1-3/8"	7/8"	3/8"	3/8"	10	[E]
220	160 mm (6-5/16") CC	8-11/16"	1/2"	1-3/8"	7/8"	3/8"	3/8"	10	[E]
272	192 mm (7-9/16") CC	10-11/16"	1/2"	1-3/8"	7/8"	3/8"	3/8"	10	[E]
304	224 mm (8-13/16") CC	11-15/16"	1/2"	1-3/8"	7/8"	3/8"	3/8"	10	[F]
336	256 mm (10-1/16") CC	13-1/4"	1/2"	1-3/8"	7/8"	3/8"	3/8"	10	[F]
368	288 mm (11-5/16") CC	14-1/2"	1/2"	1-3/8"	7/8"	3/8"	3/8"	10	[F]
399	319 mm (12-9/16") CC	15-11/16"	1/2"	1-3/8"	7/8"	3/8"	3/8"	10	[G]
496	416 mm (16-3/8") CC	19-1/2"	1/2"	1-3/8"	7/8"	3/8"	3/8"	10	[G]
560*	480 mm (18-7/8") CC	22-1/16"	1/2"	1-3/8"	7/8"	3/8"	3/8"	10	[H]
624*	544 mm (21-7/16") CC	24-9/16"	1/2"	1-3/8"	7/8"	3/8"	3/8"	10	[H]
720*	640 mm (25-3/16") CC	28-3/8"	1/2"	1-3/8"	7/8"	3/8"	3/8"	10	[J]
763*	673 mm (26-1/2") CC	30-1/16"	1/2"	1-3/8"	7/8"	3/8"	3/8"	10	[J]

*Available only in Polished Chrome and Satin Nickel

Display	Description
DBE1014-GRY	Naples hardware on Designer Grey display board, 16"W x 11"H

Finishes



BG Brushed Gold (up to 416 mm CC) **DBB** Dark Brushed Bronze (up to 416 mm CC) **MB** Matte Black (up to 416 mm CC) **PC** Polished Chrome (all lengths) **SBZ** Satin Bronze (up to 416 mm CC) **SN** Satin Nickel (all lengths)

Hollow Stainless Steel Bar Pulls

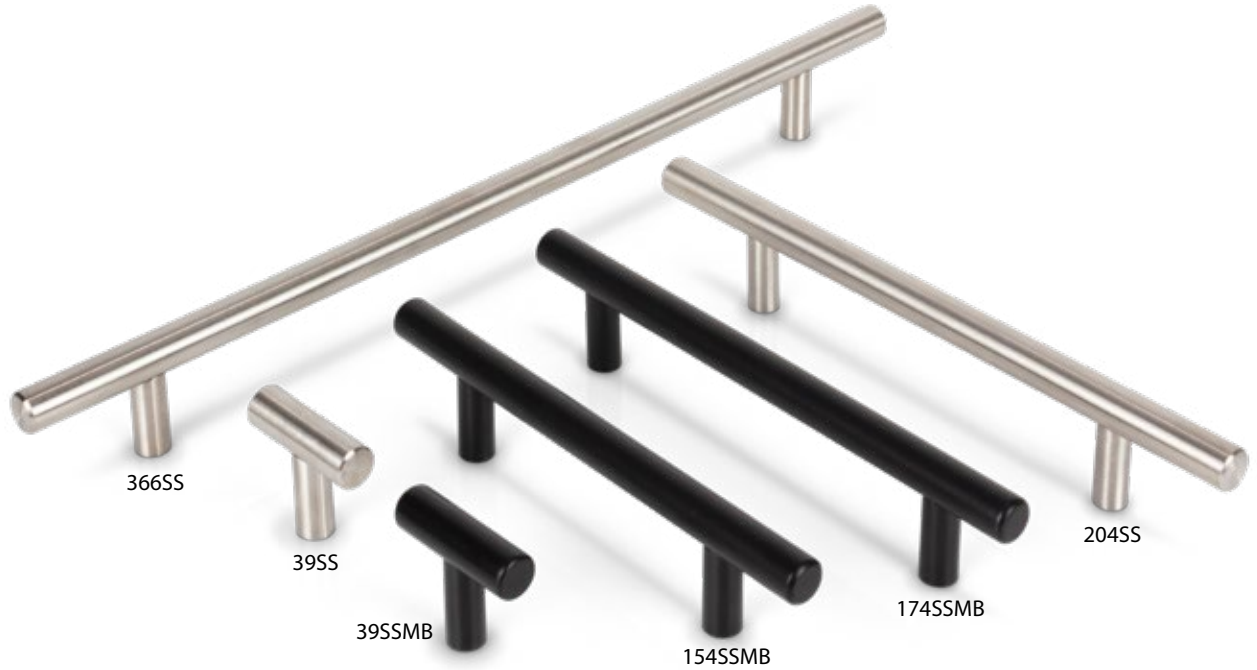

Knobs	Description	Overall Length	Width at Center	Projection	Hand Space	Foot Width	Foot Length	Inner Box	Price Code
39	T-knob	1-9/16"	1/2"	1-3/8"	7/8"	3/8"	3/8"	40	[A]
Pulls	Center-to-Center	Overall Length	Width at Center	Projection	Hand Space	Foot Width	Foot Length	Inner Box	Price Code
154	96 mm (3-3/4") CC	6-1/16"	1/2"	1-3/8"	7/8"	3/8"	3/8"	20	[C]
174	128 mm (5-1/16") CC	6-7/8"	1/2"	1-3/8"	7/8"	3/8"	3/8"	20	[D]
204	128 mm (5-1/16") CC	8-1/16"	1/2"	1-3/8"	7/8"	3/8"	3/8"	20	[E]
218	160 mm (6-5/16") CC	8-9/16"	1/2"	1-3/8"	7/8"	3/8"	3/8"	10	[E]
270	192 mm (7-9/16") CC	10-5/8"	1/2"	1-3/8"	7/8"	3/8"	3/8"	20	[E]
302	224 mm (8-13/16") CC	11-7/8"	1/2"	1-3/8"	7/8"	3/8"	3/8"	20	[E]
334	256 mm (10-1/16") CC	13-1/8"	1/2"	1-3/8"	7/8"	3/8"	3/8"	20	[F]
366	288 mm (11-5/16") CC	14-7/16"	1/2"	1-3/8"	7/8"	3/8"	3/8"	10	[F]
397	319 mm (12-9/16") CC	15-5/8"	1/2"	1-3/8"	7/8"	3/8"	3/8"	10	[F]
494	416 mm (16-3/8") CC	19-7/16"	1/2"	1-3/8"	7/8"	3/8"	3/8"	10	[G]
558	480 mm (18-7/8") CC	21-15/16"	1/2"	1-3/8"	7/8"	3/8"	3/8"	10	[G]
622	544 mm (21-7/16") CC	24-1/2"	1/2"	1-3/8"	7/8"	3/8"	3/8"	10	[H]
719	640 mm (25-3/16") CC	28-5/16"	1/2"	1-3/8"	7/8"	3/8"	3/8"	10	[H]
761	673 mm (26-1/2") CC	29-15/16"	1/2"	1-3/8"	7/8"	3/8"	3/8"	10	[H]

Display	Description
DBE1014-GRY	Naples hardware on Designer Grey display board, 16" W x 11" H

Finishes



SS
Stainless Steel







SSMB
Matte Black
Stainless Steel



Knobs	Description	Overall Length	Width at Center	Projection	Hand Space	Foot Width	Foot Length	Inner Box	Price Code
511	round knob	1-1/4"	1-1/4"	1-1/8"	7/8"	3/8"	3/8"	25	[B]

Pulls	Center-to-Center	Overall Length	Width at Center	Projection	Hand Space	Foot Width	Foot Length	Inner Box	Price Code
511-3	3" CC	4-1/16"	5/8"	1-1/8"	1"	5/8"	11/16"	15	[D]
511-96	96 mm (3-3/4") CC	4-7/8"	5/8"	1-1/8"	1"	5/8"	11/16"	15	[D]

Display	Description
DBE1037-GRY	Seaver hardware on Designer Grey display board, 16"W x 11"H

Finishes			
			
BNBDL Brushed Pewter	DBAC Brushed Oil Rubbed Bronze	PC Polished Chrome	SN Satin Nickel



Shown in Brushed Oil Rubbed Bronze



Knobs	Description	Overall Length	Width at Center	Projection	Hand Space	Foot Width	Foot Length	Inner Box	Price Code
26	round knob	1"	1"	15/16"	7/16"	3/8"	3/8"	30	[B]

Pulls	Center-to-Center	Overall Length	Width at Center	Projection	Hand Space	Foot Width	Foot Length	Inner Box	Price Code
400	3" CC	4"	5/16"	1-1/4"	3/4"	5/16"	5/16"	10	[D]
475	96 mm (3-3/4") CC	4-3/4"	3/8"	1-1/4"	11/16"	5/16"	5/16"	10	[E]
600	128 mm (5-1/16") CC	6"	3/8"	1-1/4"	11/16"	5/16"	5/16"	10	[F]

Display	Description
DBE1017-GRY	Sedona hardware on Designer Grey display board, 16"W x 11"H

Finishes



MB
Matte Black



SBZ
Satin Bronze



SN
Satin Nickel





Knobs	Description	Overall Length	Width at Center	Projection	Hand Space	Foot Width	Foot Length	Inner Box	Price Code
3915	round knob	1"	1"	15/16"	3/4"	11/16"	11/16"	50	[A]

Pulls	Center-to-Center	Overall Length	Width at Center	Projection	Hand Space	Foot Width	Foot Length	Inner Box	Price Code
984-3	3" CC	3-5/16"	7/16"	7/8"	3/4"	5/16"	5/16"	30	[C]
984-96	96 mm (3-3/4") CC	4-1/8"	7/16"	7/8"	3/4"	5/16"	5/16"	25	[C]
984-128	128 mm (5-1/16") CC	5-5/16"	7/16"	7/8"	3/4"	5/16"	5/16"	25	[D]
984-160	160 mm (6-5/16") CC	6-11/16"	1/2"	7/8"	3/4"	5/16"	5/16"	15	[D]
984-192	192 mm (7-9/16") CC	7-7/8"	1/2"	7/8"	3/4"	5/16"	5/16"	15	[E]

Display	Description
DBE1028-GRY	Slade hardware on Designer Grey display board, 16"W x 11"H

Finishes





Pulls	Center-to-Center	Overall Length	Width at Center	Projection	Hand Space	Foot Width	Foot Length	Inner Box	Price Code
8004	96 mm (3-3/4") CC	4-15/16"	3/8"	1-1/16"	15/16"	3/8"	3/4"	30	[C]
81065	128 mm (5-1/16") CC	6-1/8"	3/8"	1-1/8"	1"	7/16"	11/16"	25	[D]
80814	96 mm (3-3/4") CC	5"	7/16"	7/8"	3/4"	1/2"	13/16"	30	[B]
80815	128 mm (5-1/16") CC	6-5/16"	1/2"	1-1/8"	15/16"	9/16"	7/8"	25	[D]

Display	Description
DBE1008-GRY	Somerset hardware on Designer Grey display board, 16"W x 11"H

Finishes

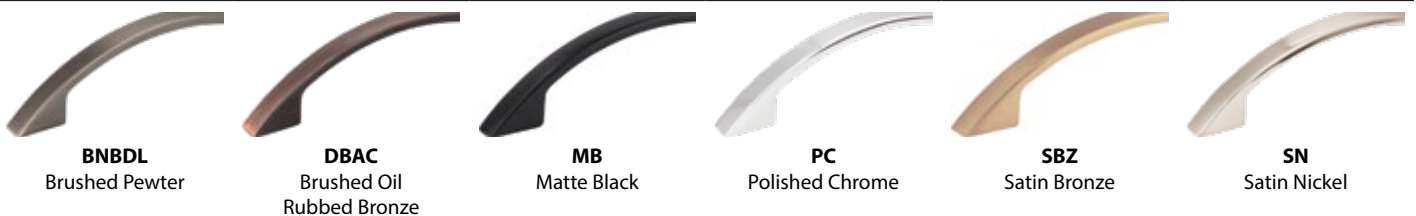



Pulls	Center-to-Center	Overall Length	Width at Center	Projection	Hand Space	Foot Width	Foot Length	Inner Box	Price Code
625-3	3" CC	3-3/8"	3/8"	1-1/8"	3/4"	3/8"	3/8"	20	[D]
625-96	96 mm (3-3/4") CC	4-1/8"	3/8"	1-1/8"	3/4"	3/8"	3/8"	25	[E]
625-128	128 mm (5-1/16") CC	5-3/8"	3/8"	1-1/8"	3/4"	3/8"	3/8"	20	[E]
625-160	160 mm (6-5/16") CC	6-5/8"	3/8"	1-1/8"	3/4"	3/8"	3/8"	10	[F]
625-192	192 mm (7-9/16") CC	7-15/16"	3/8"	1-1/8"	3/4"	3/8"	3/8"	10	[F]
625-224	224 mm (8-13/16") CC	9-3/16"	3/8"	1-1/8"	3/4"	3/8"	3/8"	10	[G]
625-320	320 mm (12-5/8") CC	12-15/16"	3/8"	1-1/8"	3/4"	3/8"	3/8"	10	[H]
625-448	448 mm (17-5/8") CC	18"	3/8"	1-1/8"	3/4"	3/8"	3/8"	10	[J]

Display Description

DBE1021-GRY Stanton hardware on Designer Grey display board, 16" W x 11" H

Finishes

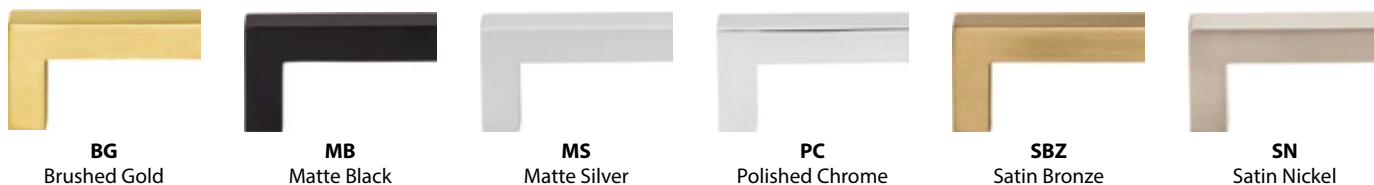

BG
Brushed Gold

MB
Matte Black

MS
Matte Silver

PC
Polished Chrome

SBZ
Satin Bronze

SN
Satin Nickel



Shown in Satin Bronze

CONFIDENT

Sleek, clean, and confident, Stanton is a perfect alternative to the traditional rounded bar pull look. With extended lengths and six finishes to choose from, this pull series flawlessly suits all cabinet styles.



Pulls	Center-to-Center	Overall Length	Width at Center	Projection	Hand Space	Foot Width	Foot Length	Inner Box	Price Code
771-3	3" CC	4-1/2"	5/8"	15/16"	3/4"	5/8"	13/16"	20	[D]
771-96	96 mm (3-3/4") CC	5-3/16"	5/8"	15/16"	13/16"	5/8"	1-1/8"	20	[D]
771-128	128 mm (5-1/16") CC	6-5/16"	5/8"	1"	7/8"	5/8"	1-1/8"	20	[E]
771-160	160 mm (6-5/16") CC	7-11/16"	5/8"	1-1/16"	15/16"	5/8"	1-3/16"	20	[F]

Display	Description
DBE1027-GRY	Strickland hardware on Designer Grey display board, 16"W x 11"H

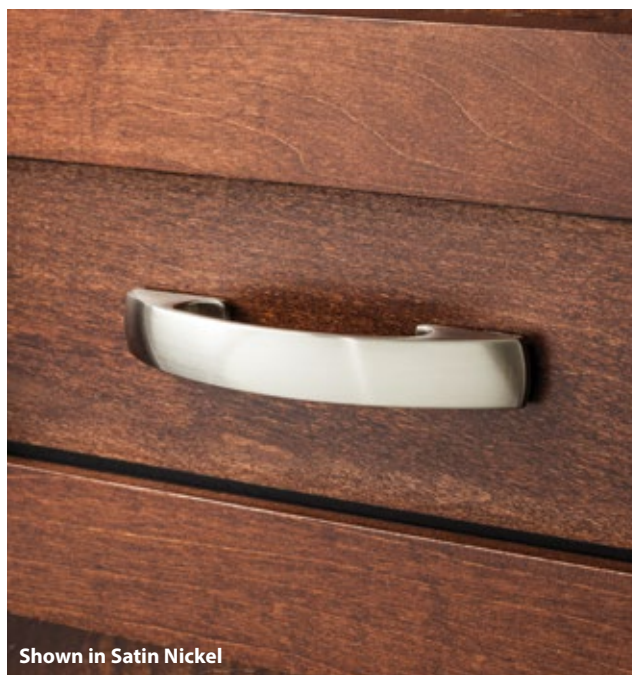



Knobs	Description	Overall Length	Width at Center	Projection	Hand Space	Foot Width	Foot Length	Inner Box	Price Code
575	round knob	1-3/16"	1-3/16"	7/8"	3/4"	3/4"	3/4"	30	[B]

Pulls	Center-to-Center	Overall Length	Width at Center	Projection	Hand Space	Foot Width	Foot Length	Inner Box	Price Code
575-96	96 mm (3-3/4") CC	4-1/2"	5/16"	1-1/8"	13/16"	3/4"	3/4"	20	[D]

Display	Description
DBE1019-GRY	Syracuse hardware on Designer Grey display board, 16" W x 11" H

Finishes



BNBDL
Brushed Pewter



DBAC
Brushed Oil
Rubbed Bronze



PC
Polished Chrome



SN
Satin Nickel



Knobs	Description	Overall Length	Width at Center	Projection	Hand Space	Foot Width	Foot Length	Inner Box	Price Code
859T	T-knob	1-7/16"	7/16"	1-1/16"	13/16"	5/16"	7/16"	25	[B]

Pulls	Center-to-Center	Overall Length	Width at Center	Projection	Hand Space	Foot Width	Foot Length	Inner Box	Price Code
859-3	3" CC	5-5/16"	7/16"	1-1/16"	7/8"	5/16"	7/16"	25	[C]
859-96	96 mm (3-3/4") CC	6-1/8"	7/16"	1-1/8"	7/8"	5/16"	7/16"	25	[C]
859-128	128 mm (5-1/16") CC	7-1/2"	7/16"	1-1/8"	15/16"	5/16"	7/16"	25	[D]
859-160	160 mm (6-5/16") CC	8-9/16"	7/16"	1-3/16"	1"	5/16"	7/16"	25	[E]

Display	Description
DBE1045-GRY	Thatcher hardware on Designer Grey display board, 16"W x 11"H

Finishes





Shown in Brushed Gold

CASUAL

A slightly round strap sitting atop the rounded feet of Thatcher creates a casual, easy-going vibe. A matching T-knob combined with extended lengths and top trending finishes make this collection the perfect match for any style of cabinets.

Design Idea

For kitchens with two-tone cabinets, using the same hardware throughout is a reliable choice that ties everything together flawlessly.



Aluminum Pulls

Aluminum Pulls	Center-to-Center	Overall Length	Width at Center	Projection	Hand Space	Foot Width	Foot Length	Inner Box	Price Code
A271-3AL	3" CC	3-5/16"	5/16"	1-1/4"	15/16"	5/16"	5/16"	30	[A]
A271-3.5AL	3-1/2" CC	3-13/16"	5/16"	1-1/4"	15/16"	5/16"	5/16"	30	[A]
A271-96AL	96 mm (3-3/4") CC	4-1/16"	5/16"	1-1/4"	15/16"	5/16"	5/16"	30	[A]
A271-4AL	4" CC	4-5/16"	5/16"	1-1/4"	15/16"	5/16"	5/16"	30	[A]

Stainless Steel Pulls

Stainless Steel Pulls	Center-to-Center	Overall Length	Width at Center	Projection	Hand Space	Foot Width	Foot Length	Inner Box	Price Code
K271-3SS	3" CC	3-5/16"	5/16"	1-1/4"	15/16"	5/16"	5/16"	30	[D]
K271-3.5-SS	3-1/2" CC	3-13/16"	5/16"	1-1/4"	15/16"	5/16"	5/16"	30	[C]
K271-96-SS	96 mm (3-3/4") CC	4-1/16"	5/16"	1-1/4"	15/16"	5/16"	5/16"	30	[C]
K271-4SS	4" CC	4-5/16"	5/16"	1-1/4"	15/16"	5/16"	5/16"	30	[D]

Steel Pulls

Steel Pulls	Center-to-Center	Overall Length	Width at Center	Projection	Hand Space	Foot Width	Foot Length	Inner Box	Price Code
S271-3	3" CC	3-5/16"	5/16"	1-1/4"	15/16"	5/16"	5/16"	30	[A]
S271-3.5	3-1/2" CC	3-13/16"	5/16"	1-1/4"	15/16"	5/16"	5/16"	30	[A]
S271-96	96 mm (3-3/4") CC	4-1/16"	5/16"	1-1/4"	15/16"	5/16"	5/16"	30	[A]
S271-4	4" CC	4-5/16"	5/16"	1-1/4"	15/16"	5/16"	5/16"	30	[A]
S271-128	128 mm (5-1/16") CC	5-5/16"	5/16"	1-1/4"	15/16"	5/16"	5/16"	20	[A]

Finishes

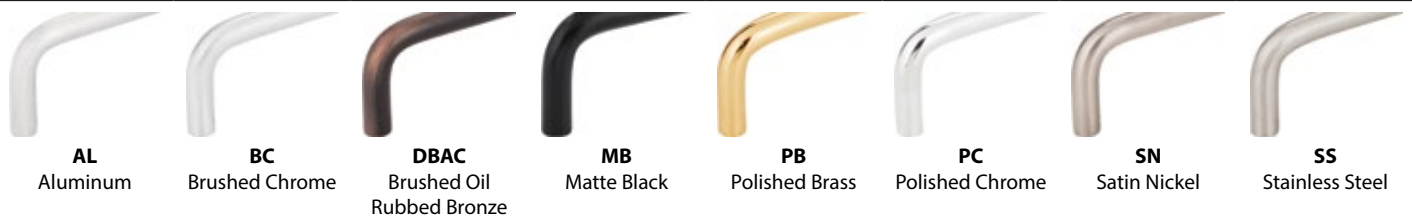



Knobs	Description	Overall Length	Width at Center	Projection	Hand Space	Foot Width	Foot Length	Inner Box	Price Code
413322*	T-knob	1-9/16"	1/2"	7/8"	7/16"	3/8"	3/4"	100	[A]
409222*	T-knob	1-9/16"	1/2"	7/8"	7/16"	3/8"	3/4"	100	[A]

Pulls	Center-to-Center	Overall Length	Width at Center	Projection	Hand Space	Foot Width	Foot Length	Inner Box	Price Code
Z105	3" CC	3-7/8"	1/2"	1-1/16"	3/4"	1/4"	1/4"	50	[B]
4655	128 mm (5-1/16") CC	6-1/4"	3/16"	1-1/4"	1-1/16"	7/16"	13/16"	25	[D]
346564	128 mm (5-1/16") CC	6"	3/8"	1-1/8"	3/4"	3/8"	5/8"	30	[D]
4307305	192 mm (7-9/16") CC	8-5/8"	3/8"	1-3/8"	15/16"	3/8"	3/4"	20	[E]
413321*	128 mm (5-1/16") CC	7-3/8"	9/16"	1-3/8"	7/8"	5/16"	5/16"	20	[E]
409223*	128 mm (5-1/16") CC	7-3/8"	9/16"	1-3/8"	7/8"	5/16"	5/16"	20	[E]
7210	3" CC cup pull	5-3/4"	13/16"	3/4"	5/8"	3/4"	5-3/4"	50	[C]
R1011†	3" CC pull & backplate	3-13/16"	2-1/16"	1/2"	1/16"	2-1/16"	3-13/16"	15	[E]
R1012†	2-1/4" CC vertical pull & backplate	3-13/16"	1-1/2"	1/2"	1/16"	1"	3-13/16"	25	[D]

*M4 attachment screws included with this item

† Attachment screws not included - use item number 32BREAK. This pull has posts that needs an easy extra step to achieve a flush mount. Once you have drilled your hole with a 3/16" bit, use a 1/4" bit to expand the hole on the face of the door/drawer front to seat the post of the pull.

AB	Brushed Antique Brass
BLK/MB	Matte Black
MS	Matte Silver
SN	Satin Nickel



Knobs	Description	Overall Length	Width at Center	Projection	Hand Space	Foot Width	Foot Length	Inner Box	Price Code
110	stacked knob	1-1/4"	1-1/4"	1-1/16"	3/4"	13/16"	13/16"	30	[B]
202	ringed knob	1-1/4"	1-1/4"	1"	5/8"	3/8"	3/8"	50	[A]

Pulls	Center-to-Center	Overall Length	Width at Center	Projection	Hand Space	Foot Width	Foot Length	Inner Box	Price Code
110-3	3" CC	5-1/2"	1/2"	1-3/16"	13/16"	3/4"	1-7/16"	25	[C]
P106	3" CC	5-1/16"	9/16"	15/16"	3/4"	9/16"	3/4"	50	[B]

Finishes



DBAC
Brushed Oil
Rubbed Bronze



SN
Satin Nickel



Shown in Brushed Oil Rubbed Bronze



Knobs	Description	Overall Length	Width at Center	Projection	Hand Space	Foot Width	Foot Length	Inner Box	Price Code
647	round knob	1-1/8"	1-1/8"	15/16"	11/16"	5/8"	5/8"	20	[A]

Pulls	Center-to-Center	Overall Length	Width at Center	Projection	Hand Space	Foot Width	Foot Length	Inner Box	Price Code
647-3	3" CC	4-5/8"	1/2"	1"	3/4"	7/8"	15/16"	15	[B]
647-96	96 mm (3-3/4") CC	5-3/8"	1/2"	1"	3/4"	7/8"	15/16"	20	[D]

Display	Description
DBE1031-GRY	Watervale hardware on Designer Grey display board, 16"W x 11"H

Finishes



BNBDL
Brushed Pewter



DBAC
Brushed Oil Rubbed Bronze



PC
Polished Chrome



SN
Satin Nickel



Shown in Brushed Oil Rubbed Bronze



Walker 1

Knobs	Description	Overall Length	Width at Center	Projection	Hand Space	Foot Width	Foot Length	Inner Box	Price Code
827	square knob	1-1/4"	1-1/4"	1-1/8"	11/16"	3/8"	3/8"	25	[D]
827L	large square knob	1-5/8"	1-5/8"	1-1/4"	11/16"	1/2"	1/2"	10	[D]
Pulls	Center-to-Center	Overall Length	Width at Center	Projection	Hand Space	Foot Width	Foot Length	Inner Box	Price Code
827-96	96 mm (3-3/4") CC	4-1/8"	3/4"	1-1/4"	7/8"	3/4"	3/8"	10	[E]
827-128	128 mm (5-1/16") CC	5-3/8"	3/4"	1-1/4"	7/8"	3/4"	3/8"	10	[F]
827-160	160 mm (6-5/16") CC	6-11/16"	3/4"	1-1/4"	7/8"	3/4"	3/8"	10	[F]
827-192	192 mm (7-9/16") CC	7-15/16"	3/4"	1-1/4"	7/8"	3/4"	3/8"	10	[G]
827-12	12" CC appl. handle	12-1/2"	1-1/8"	1-3/4"	1-1/4"	1-1/8"	1/2"	5	[K]

Walker 2

Pulls	Center-to-Center	Overall Length	Width at Center	Projection	Hand Space	Foot Width	Foot Length	Inner Box	Price Code
727-96	96 mm (3-3/4") CC	4"	1/2"	1-1/8"	7/8"	1/2"	1/4"	25	[D]
727-128	128 mm (5-1/16") CC	5-5/16"	1/2"	1-1/8"	7/8"	1/2"	1/4"	15	[D]
727-160	160 mm (6-5/16") CC	6-9/16"	1/2"	1-1/8"	7/8"	1/2"	1/4"	15	[E]
727-192	192 mm (7-9/16") CC	7-13/16"	1/2"	1-1/8"	7/8"	1/2"	1/4"	15	[E]

Displays

Displays	Description
DBE1050-GRY	Walker 1 hardware (3/4" wide) on Designer Grey display board, 16"W x 11"H
DBE1051-GRY	Walker 2 hardware (1/2" wide) on Designer Grey display board, 16"W x 11"H



Shown in Matte Black

STRIKING

Simplistic yet striking, Walker adds a balanced look to any space with long, clean lines and a comfortable, ergonomic grip. This collection stands apart from others by offering four standard pull lengths in two widths, ½" and ¾", to satisfy all design aesthetics.

Finishes



BG
Brushed Gold



BNBDL
Brushed Pewter



MB
Matte Black



PC
Polished Chrome



SBZ
Satin Bronze



SN
Satin Nickel



Knobs	Description	Overall Length	Width at Center	Projection	Hand Space	Foot Width	Foot Length	Inner Box	Price Code
641	square knob	1-1/4"	1-1/4"	1-3/16"	13/16"	5/16"	9/16"	25	[C]

Pulls	Center-to-Center	Overall Length	Width at Center	Projection	Hand Space	Foot Width	Foot Length	Inner Box	Price Code
641-3	3" CC	4-1/4"	5/8"	1-1/8"	7/8"	1/4"	7/16"	20	[D]
641-96	96 mm (3-3/4") CC	5"	5/8"	1-1/8"	7/8"	1/4"	7/16"	15	[D]
641-128	128 mm (5-1/16") CC	6-1/4"	5/8"	1-1/8"	7/8"	1/4"	7/16"	15	[E]
641-160	160 mm (6-5/16") CC	7-1/2"	5/8"	1-1/8"	7/8"	1/4"	7/16"	10	[F]

Display	Description
DBE1052-GRY	William hardware on Designer Grey display board, 16"W x 11" H

Finishes





Shown in Satin Nickel

SCULPTED





William embodies bold modernistic design, captivating all with its intricately sculpted yet soft geometric form. It offers four pull lengths and a coordinating knob in seven stunning finishes. The collection's angular facets effortlessly infuse a subtle hint of contemporary flair to any cabinet or furniture piece it adorns. Embracing the core of the modernist spirit, William creates an ambiance beyond the ordinary.



Knobs	Description	Overall Length	Width at Center	Projection	Hand Space	Foot Width	Foot Length	Inner Box	Price Code
3898	round knob	1-3/16"	1-3/16"	1-1/4"	3/4"	11/16"	11/16"	20	[C]

Pulls	Center-to-Center	Overall Length	Width at Center	Projection	Hand Space	Foot Width	Foot Length	Inner Box	Price Code
3899	3" CC	5-3/16"	5/16"	15/16"	3/4"	13/16"	1-5/16"	25	[B]

Display	Description
DBE1016-GRY	Westbury hardware on Designer Grey display board, 16" W x 11" H

Finishes			
			
BNBDL Brushed Pewter	DBAC Brushed Oil Rubbed Bronze	PC Polished Chrome	SN Satin Nickel



Shown in Satin Nickel



Knobs	Description	Overall Length	Width at Center	Projection	Hand Space	Foot Width	Foot Length	Inner Box	Price Code
988	round knob	1-1/16"	1-1/16"	1"	3/4"	7/16"	7/16"	25	[A]

Pulls	Center-to-Center	Overall Length	Width at Center	Projection	Hand Space	Foot Width	Foot Length	Inner Box	Price Code
988-3	3" CC	3-3/4"	3/8"	1-3/16"	3/4"	5/16"	9/16"	20	[B]
988-96	96 mm (3-3/4") CC	4-1/2"	3/8"	1-3/16"	3/4"	5/16"	9/16"	20	[D]
988-128	128 mm (5-1/16") CC	5-13/16"	1/2"	1-1/4"	3/4"	5/16"	9/16"	15	[D]
988-160	160 mm (6-5/16") CC	7-1/16"	1/2"	1-1/4"	3/4"	5/16"	9/16"	10	[E]

Display	Description
DBE1030-GRY	Zachary hardware on Designer Grey display board, 16"W x 11"H

Finishes



BNBDL Brushed Pewter **DBAC** Brushed Oil Rubbed Bronze **MB** Matte Black **PC** Polished Chrome **SN** Satin Nickel

Backplates



Shown with Gibson knob 105SN



Shown with Durham pull Z290-96-MB



Plain detail



Rope detail

Item	Description	Finishes	Overall Length	Width	Inner Box	Price Code
B812 [†]	plain knob backplate	AB, ABM-D, ABSB, AEM, ASM, BC, BLK, BNB, BNBDL, DACM, DBAC, ORB, PC, SB, SBN, SN	2-13/16"	1"	50	[C]
B812-96 [†]	plain 96 mm CC backplate	AB, ABM-D, ABSB, AEM, ASM, BC, BK, BNB, BNBDL, DACM, DBAC, ORB, PC, SB, SBN, SN	6-1/8"	1-1/4"	30	[E]
B812-96R [†]	rope 96 mm CC backplate	ABSB, BNB, BNBDL, DACM, DBAC, ORB, SN	6-1/8"	1-1/4"	30	[E]

Finishes



AB
Brushed Antique Brass



ABM-D
Distressed Antique Brass



ABSB
Antique Brushed Satin Brass



AEM
Lightly Distressed Antique Brass



ASM
Distressed Antique Silver



BC
Brushed Chrome



BK/BLK
Matte Black



BNB
Brushed Black Nickel



BNBDL
Brushed Pewter



DACM
Gun Metal



DBAC
Brushed Oil Rubbed Bronze



ORB
Dark Bronze



PC
Polished Chrome



SB
Satin Brass



SBN
Satin Black Nickel



SN
Satin Nickel

These products are being retired. Check availability online or call for products marked with "†"



CL101DBAC



CL101SN



CL101NI

Item	Description	Inner Box	Price Code
CL101 [†]	1-3/4" OL x 1-13/16" W Cabinet Latch (#5 x 5/8" wood screws included)	25	[G]

Finishes



DBAC
Brushed Oil
Rubbed Bronze



NI
Polished Nickel



SN
Satin Nickel

Finial Hinges



0128AB



0148MB
"A" style slim form
minaret tips



0158NI
"B" style rounded
minaret tips



0178SN[†]

Item	Description	Height	Inner Box	Master Carton	Finishes
0128	Full Wrap Around Hinge, 270° opening	2-3/4"	-	250	AB, DBAC, MB, SN
0148	Partial Wrap Around Hinge, 270° opening	2-3/4"	-	250	AB, DBAC, MB, SN
0158	Partial Wrap Around Hinge, 270° opening	2-3/4"	50	300	DBAC, NI, SN
0178 [†]	Partial Wrap Around Hinge, 270° opening	4"	50	200	SN

*Finial hinges are designed for 3/4" frame material and 3/4" thick door

Finishes



AB
Brushed Antique
Brass



DBAC
Brushed Oil
Rubbed Bronze



MB
Matte Black



NI
Polished Nickel



SN
Satin Nickel

SAVE TIME & MONEY

installing decorative hardware



Professional Grade Drilling Jig

- Fast and accurate
- Adjustable for up to 12" CC
- Centers on any width drawer up to 16" wide
- Stile and rail minimum width of 1/2"
- Durable aircraft quality anodized aluminum
- Made in the USA



Professional Grade
Hardware Drilling Jig
Item #: HDJ-300

Includes:

- T-square with center bushing
- 2 sliding drill guides
- End stop
- Top stop
- 5 mm drill bit
- Carrying Case





Drilling Jig Extension Set

- Allows for fast installation of cabinet handles up to 38" CC (960mm) when attached to HDJ-300 (Sold Separately)
- End Stop centers on any width of drawer up to 42" wide
- Doubles as a portable 32mm shelf pin jig
- Stile and rail minimum width of 1/2"
- Durable aircraft quality anodized aluminum
- Made in the USA



Includes:

- Long Pull / Shelf Pin Extensions
- Extended Ruler Attachment w/ Double Bracket
- 5mm Drill Bit

Hardware Drilling Jig Extension Set
Item #: HDJ-960-EXT

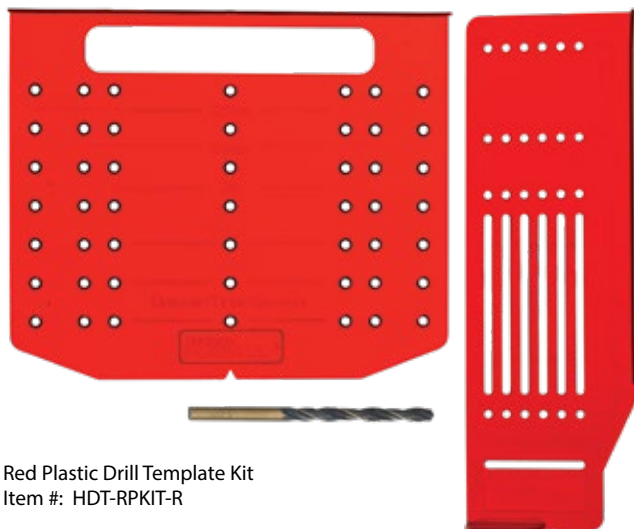

Red Plastic Drill Template Kit
Item #: HDT-RPKIT-R

Knob & Pull Drill Template Kit

- Easily install knobs and pulls ranging from 3" to 128 mm (5-1/16") CC on cabinet doors and drawers in three to four easy steps.
- Align the template on the cabinet door or drawer and mark the desired locations of the hardware. Drill using the 3/16" drill bit, then install!
- Retail packaged

Includes:

- Red Plastic Door Template
- Red Plastic Drawer Template
- 3/16" drill bit



Large Selection – Small Footprint



36-Board Tower
Part number DISPLAY-36
35" x 35" x 81"

36-Board Tower is our most popular display

18-Board Compact Tower

Revolves 360°

24" base footprint

Contemporary design

3 Jeffrey Alexander® headers included

Elements™ headers also available

Over 100 collections

60+ collections and 2,000 products in the Jeffrey Alexander brand

40+ collections and 1,000 products in the Elements brand

Decorative Hardware Boards can be displayed on a 36-Board tower, an 18-Board tower, or wall/slat wall mounted

Ask about the most popular collections in your area



18-Board Tower
Part number DISPLAY-18
24" x 24" x 81"

Display Towers	Description
DISPLAY-36	36-board tower with Jeffrey Alexander headers
DISPLAY-18	18-board tower with Jeffrey Alexander headers

Accessories	Description
D-36-HEAD-ELE	Elements header for DISPLAY-36
D-18-HEAD-ELE	Elements header for DISPLAY-18
DBSWM	Slat wall bracket for display boards
DBWM	Wall mounting bracket for boards

Quickly select decorative hardware

The price code on our Designer Grey display boards under each piece, and a corresponding price code key on the tower edge or wall, make it fast and simple for your staff and your customer to know the approximate price at a glance.

- Price code key available in a sticker for the tower (part number DISPLAY-KEY24) or as a printable PDF for framing.
- Price code key sticker is sized to fit on the edge of the wings of our displays
- Set your own pricing for your market with the digital version of the price code key, which you can update and print yourself
- Change prices each year by changing the price code key, not the display board

Label	Price Range*
[A]	Under \$3.50
[B]	~\$3.50 – \$5.00
[C]	~\$5.00 – \$6.00
[D]	~\$6.00 – \$8.50
[E]	~\$8.50 – \$10.75
[F]	~\$10.75 – \$14.50
[G]	~\$14.50– \$18.00
[H]	~\$18.00 – \$23.75
[J]	~\$23.75 – \$31.00
[K]	See Sales Associate

DISPLAY-KEY24
2-1/4" x 5-1/2"



Price codes are listed on our Designer Grey boards as well as on every collection page in this catalog

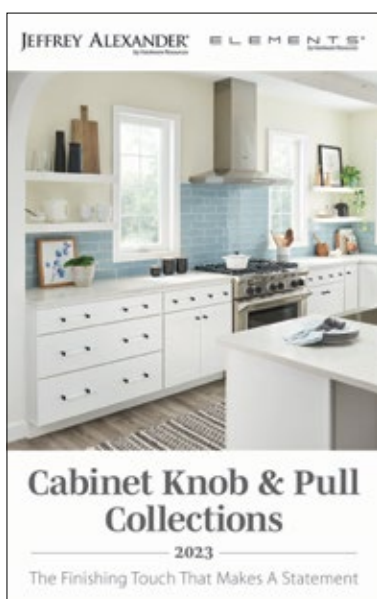

Our most popular collections in a consumer-friendly format

This FREE resource gives your customers a quick view of our popular collections with letter price codes to make quoting knobs and pulls a breeze. This consumer-focused half-size catalog saves you time while helping your customers pick the perfect knobs and pulls for their cabinets.

Ask your sales rep for your complimentary copies today.

◆ Patented & Original Designs



Alvar ◆

DB801-GRY



Annadale ◆

DB982-GRY



Anwick ◆

DB993-GRY



Audrey ◆

DB819-GRY



Belcastel 1 ◆

DB971-GRY



Bella ◆

DB975-GRY

Display boards are 16" x 11"

◆ Patented & Original Designs



Bordeaux

DB925-GRY



Boswell

DB805-GRY



Bremen 1 ◆

DB974-GRY



Bremen 2 ◆

DB973-GRY



Cairo

DB981-GRY



Callie ◆

DB998-GRY

Display boards are 16" x 11"

◆ Patented & Original Designs



Carmen ◆

DB817-GRY



Chesapeake

DB941-GRY



Cordova

DB955-GRY

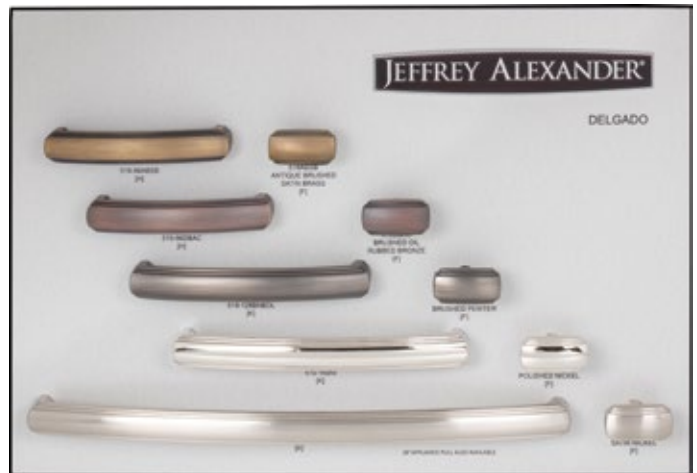

Delgado ◆

DB944-GRY



Delmar ◆

DB980-GRY



Dominique ◆

DB814-GRY

Display boards are 16" x 11"

◆ Patented & Original Designs



Katharine ◆

DB991-GRY



Key Grande

DB963-GRY



Key West & Key Largo

DB905-GRY



Lafayette ◆

DB945-GRY



Larkin 1

DB821-GRY



Larkin 2

DB822-GRY

Display boards are 16" x 11"

◆ Patented & Original Designs



Larkin Combination (1-4) *NEW*

DB827-GRY



Lexa ◆

DB986-GRY



Leyton ◆

DB800-GRY



Loxley ◆ *NEW*

DB826-GRY



Lyon

DB924-GRY



Marie ◆

DB816-GRY

Display boards are 16" x 11"

◆ Patented & Original Designs



Marlo ◆

DB997-GRY



Merrick

DB984-GRY



Milan 1 ◆

DB988-GRY



Mirada

DB929-GRY



Philip ◆

DB815-GRY



Regan

DB985-GRY

Display boards are 16" x 11"

◆ Patented & Original Designs



Renzo ◆

DB818-GRY



Richard ◆

DB820-GRY



Roman ◆

DB812-GRY



Royce

DB990-GRY



Sonoma

DB964-GRY

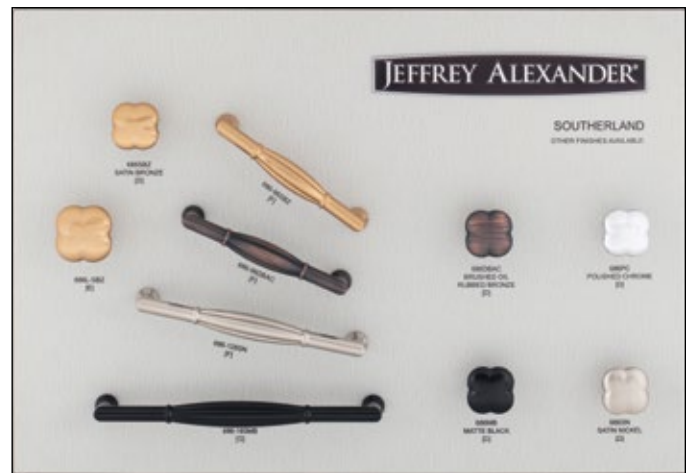

Southerland ◆ **NEW**

DB825-GRY

Display boards are 16" x 11"

◆ Patented & Original Designs

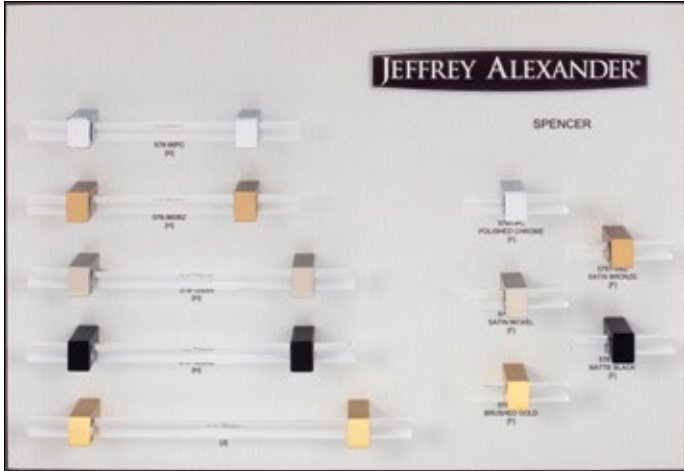

Spencer

DB823-GRY



Sullivan ◆

DB810-GRY



Sutton

DB967-GRY

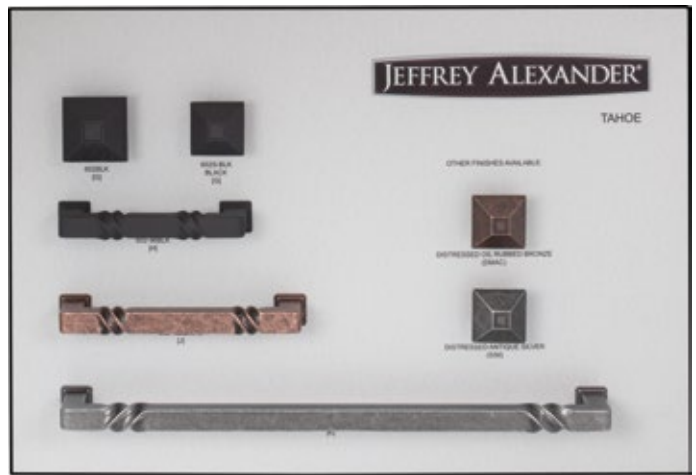

Tahoe ◆

DB949-GRY



Tiffany ◆

DB994-GRY



Wheeler ◆

DB813-GRY

Display boards are 16" x 11"

◆ Patented & Original Designs



Whitlock ◆ *NEW*

DB824-GRY



Zane ◆

DB802-GRY



Matte Black Finish Board

DB806-GRY



Satin Bronze & Brushed Gold Finish Board

DB807-GRY



Brushed Gold Finish Board

DB808-GRY

Display boards are 16" x 11"

◆ Patented & Original Designs



Aiden

DBE1039-GRY



Asher

DBE1023-GRY



Belfast

DBE1018-GRY



Brenton

DBE1024-GRY



Cosgrove ◆

DBE1025-GRY



Edgefield

DBE1029-GRY

Display boards are 16" x 11"



Florence

DBE1012-GRY



Gibson

DBE1046-GRY



Glendale

DBE1013-GRY



Hadly ♦

DBE1036-GRY

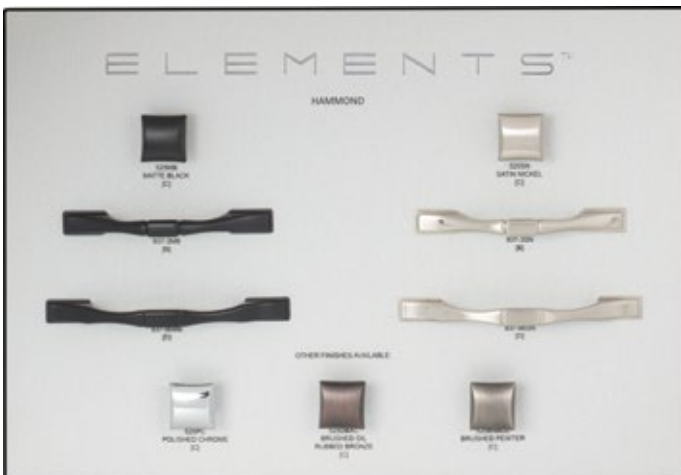

Hammond

DBE1034-GRY



Kenner

DBE1032-GRY

Display boards are 16" x 11"

◆ Patented & Original Designs



Knox

DBE1044-GRY



Lindos

DBE1020-GRY



Madison

DBE1040-GRY



Merryville

DBE1033-GRY



Naples

DBE1014-GRY



Park ◆

DBE1038-GRY

Display boards are 16" x 11"



Seaver ◆

DBE1037-GRY



Sedona

DBE1017-GRY



Slade

DBE1028-GRY



Somerset

DBE1008-GRY



Stanton

DBE1021-GRY



Strickland

DBE1027-GRY

Display boards are 16" x 11"

◆ Patented & Original Designs

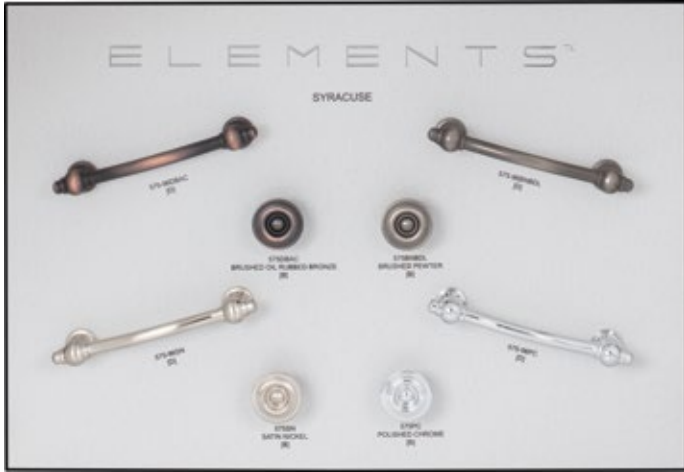

Syracuse ◆

DBE1019-GRY



Thatcher

DBE1045-GRY



Walker 1

DBE1050-GRY



Walker 2

DBE1051-GRY



Watervale

DBE1031-GRY



Westbury

DBE1016-GRY

Display boards are 16" x 11"

Display Boards - Variety



Hooks (see pages 219-222 for Hooks)

DBHKE01-GRY



Elements Variety, Grey

DBEVAR3-FG



Elements Variety, White

DBEVAR3-WH

Display boards are 18" x 24"
Wall mount only, do not fit on our DISPLAY-18 or DISPLAY-36 towers.



Essentials Variety

DBV-A3-FG

24" x 18" (wall mount only, does not fit on display towers)



Plus Variety

DBV-A5-FG

24" x 18" (wall mount only, does not fit on display towers)



Premium Variety

DBV-A7-FG

24" x 18" (wall mount only, does not fit on display towers)

Item Number Index

ITEM NUMBER	PAGE	ITEM NUMBER	PAGE	ITEM NUMBER	PAGE	ITEM NUMBER	PAGE	ITEM NUMBER	PAGE
26	163	193-4	133	329-12	74	484-32	50	598-128	69
39	161	193-96	133	329-18	74	484-305	50	598-160	69
40	160	193-128	133	329-96	74	484-396	50	598-192	69
48	64	193-160	133	329-128	74	484-128160	50	598-305	69
51	62	202	151, 174	329-160	74	484-192224	50	600	163
105	144	204	161	329-192	74	494	161	602	108
105-12	144	206	160	329-305	74	496	160	602-12	108
105-96	144	218	70, 161	329L	74	498T	69	602-96	108
105-128	144	220	160	331	136	511	162	602-128	108
105-160	144	239	135	331-96	136	511-3	162	602S	108
105-192	144	239-96	135	331-128	136	511-96	162	618	49
105-224	144	239-128	135	331L	136	516	132	618L	49
105-305	144	239-160	135	334	161	519	44	622	161
105L	144	239-192	135	336	160	519-12	44	624	160
107	132	242	64	351	136	519-18	44	625-3	166
110	174	0251	43	351-96	136	519-96	44	625-96	166
110-3	174	254-3	150	351-128	136	519-128	44	625-128	166
117	32	254-96	150	351L	136	519-160	44	625-160	166
127	34	259	71	366	161	525	146, 147	625-192	166
136	160	259-96	71	368	160	525-96	146	625-224	166
137	34	259-128	71	370	64	527	32	625-320	166
141	90	259-160	71	382	138	527-12	32	625-448	166
141-96	90	259-192	71	382-96	138	527-128	32	635-32	106
141-128	90	264-3	18	382-128	138	527-160	32	635-96	106
141-160	90	264-96	18	382-160	138	530	64	635-128	106
141-192	90	264-128	18	397	161	535	17	635-160	106
141-305	90	264-160	18	399	160	535-96	17	635-256	106
141L	90	264-192	18	400	163	535-128	17	641	178
146	64	270	161	406-128	134	535-160	17	641-3	178
152	64	272	160	417	70	535L	17	641-96	178
154	161	274	64	431	93, 98	536-96	17	641-128	178
156	160	278	24	435	20	536-128	17	641-160	178
165	52	278-12	24	435-96	20	537	34	645-96	152
165-12	52	278-18	24	435-128	20	537-12	34	645-128	152
165-96	52	278-96	24	435-160	20	537-128	34	645-160	152
165-128	52	278-128	24	435L	20	537-160	34	645-192	152
165-160	52	278-160	24	436-96	20	549-96	80	645-224	152
171	94	278-192	24	436-128	20	549-128	80	645-320	152
171-12	94	278-224	24	445	78	549-160	80	647	175
171-18	94	278-305	24	445-12	78	549-192	80	647-3	175
171-96	94	278L	24	445-18	78	549-320	80	647-96	175
171-128	94	286-96	72	445-96	78	558	161	650	58
171-160	94	286-128	72	445-128	78	560	160	650-12	58
171-192	94	286-160	72	445-160	78	575	169	650-96	58
171-305	94	286-192	72	445-192	78	575-96	169	650-128	58
171L	94	286-224	72	445-224	78	578-96	102	650-160	58
174	161	293-96	116	445-305	78	578-128	102	658	110
176	160	293-128	116	449	148	578-160	102	658-12	110
177-128	30	293-160	116	449-3	148	578T	102	658-96	110
177-160	30	293-192	116	449-96	148	585	45	658-128	110
177-192	30	293-224	116	449-128	148	585-12	45	658-160	110
177-224	30	293-305	116	449-160	148	585-96	45	658-192	110
178	64	293T	116	475	163	585-128	45	658-224	110
183	157	302	161	478-12	68	585-160	45	667	88
183-3	157	304	160	478-18	68	585L	45	667-3	88
183-96	157	308-128	134	478-96	68	595	36, 93	667-12	88
188	60	317	70	478-128	68	595-96	36	667-18	88
188-96	60	317-12	70	478-160	68	595-128	36	667-96	88
188-128	60	317-96	70	478-192	68	596	62	667-128	88
188-160	60	317-128	70	478-305	68	598-12	69	667-160	88
188L	60	317-160	70	478T	68	598-18	69	667-224	88
193-3	133	329	74	484	50	598-96	69	667-305	88

Item Number Index

Knobs & Pulls

ITEM NUMBER	PAGE	ITEM NUMBER	PAGE	ITEM NUMBER	PAGE	ITEM NUMBER	PAGE	ITEM NUMBER	PAGE
667L	88	798-160	93	905-128	114	3960	143	G130L	54
667S	88	818	28	905-160	114	3970	143, 150	G140	54
678	112	818-12	28	905-192	114	3980	48	G140L	54
678-18	112	818-96	28	905-305	114	3990	29	G150	54
678-96	112	818-128	28	915	42	3991	76	G150L	54
678-128	112	818-160	28	937-3	147	4128	98	K271-3.5-SS	172
678-160	112	818L	28	937-96	147	4160	98	K271-3SS	172
686	100	827	176	944	96	4192	98	K271-4SS	172
686-96	100	827-12	176	944-12	96	4288	98	K271-96-SS	172
686-128	100	827-96	176	944-96	96	4655	151, 173	MO6303	26
686-160	100	827-128	176	944-128	96	4656	137	MO6373	26
698-12	69	827-160	176	944-160	96	4690	137	MO6373-12	26
698-18	69	827-192	176	944-192	96	5128	62	MO6373-18	26
698-96	69	827L	176	944-224	96	5192	62	MO6373-128	26
698-128	69	839-3	38	944-305	96	5224	62	MO6373-160	26
698-160	69	839-96	38	950	64	5319	62	P106	174
698-192	69	839-128	38	972	77	5480	62	R1011	173
698-305	69	839-160	38	972-12	77	5673	62	R1012	173
718	49	840	151	972-96	77	5900	62	S271-3	172
718-128	49	845	46	972-128	77	7210	173	S271-3.5	172
719	161	845-12	46	972-160	77	8004	165	S271-4	172
720	160	845-18	46	972-224	77	8233	76	S271-96	172
722	64	845-96	46	972-305	77	8236	29	S271-128	172
727-96	176	845-128	46	972L	77	80152-96	84	S6060	92
727-128	176	845-160	46	972S	77	80152-128	84	WB150	151
727-160	176	845-192	46	976-128	134	80152-160	84	WK150	151
727-192	176	845-305	46	984-3	164	80814	165	WP150	151
737-12	42	845T	46	984-96	164	80815	165	Z105	173
737-96	42	845TL	46	984-128	164	81021	84	Z110	42, 43
737-128	42	847-96	89	984-160	164	81065	165	Z111	43
737-160	42	847-128	89	984-192	164	346564	173	Z115	154
745-128	134	847-160	89	988	181	409222	173	Z115-96	154
749	109	859-3	170	988-3	181	409223	173	Z115-128	154
749-96B	109	859-96	170	988-96	181	411689	137	Z115L	154
749-128	109	859-128	170	988-128	181	412461	137	Z118	139
749-128B	109	859-160	170	988-160	181	413321	173	Z118-3	139
749-160	109	859T	170	993	130	413322	173	Z118-96	139
749-224	109	867	22	993-3	130	417572	137	Z205	137
752-19	104	867-3	22	993-96	130	530142	137	Z259-3	155
752-96	104	867-96	22	993-128	130	530143	137	Z260-3	92
752-128	104	867-128	22	0128	183	530144	137	Z260-12	92
752-160	104	867-160	22	0148	183	4307305	173	Z261-96	92
752-192	104	867-228	22	0158	183	A271-3.5AL	172	Z261-128	92
752-224	104	867-320	22	0178	183	A271-3AL	172	Z280	43
761	161	867L	22	1018	151	A271-4AL	172	Z281	43
763	160	875	151	1091	82	A271-96AL	172	Z281-12	43
767	86	878	151	1092	82	A500-3	140	Z281-18	43
767-96	86	885	56	1092-12	82	A500-4	140	Z281-128	43
767-128	86	885-96	56	1092-128	82	A500-6	140	Z281-160	43
767-160	86	885-128	56	1092-160	82	A500-8	140	Z290-3	48
771-3	168	885-160	56	2980	142	A500-10	140	Z290-12	48
771-96	168	885-192	56	2981	142	A500-12	140	Z290-96	48
771-128	168	885-224	56	3108	143	A500-125	140	Z290-128	48
771-160	168	885-305	56	3208	143, 151	B812	182	Z290-160	48
775	40	885L	56	3211	137	B812-96	92, 182	Z500-128	137
775-96	40	897	156	3308	143	CH3503	151	Z718-12	49
775-128	40	897-3	156	3898	180	CL101	183		
775-160	40	897L	156	3899	180	G110	54		
775L	40	905	114	3910	155	G110L	54		
776-128	134	905-12	114	3915	164	G120	54		
798-96	93	905-18	114	3940	143	G120L	54		
798-128	93	905-96	114	3950	143	G130	54		

Find trending finishes in our most popular collections

JEFFREY ALEXANDER® by Hardware Resources

Collection	Brushed Gold (BG/ABG/MBBG)	Matte Black (MB/BLK/MBSS/MBSN)	Satin Bronze (SBZ/MBSBZ)	See Page
Alvar		✓	✓	18
Annadale		✓		20
Audrey	✓	✓	✓	24
Belcastel 1		✓	✓	26
Boswell		✓		30
Bremen 1			✓	32
Callie		✓	✓	38
Carmen	✓	✓	✓	40
Dominique	✓	✓	✓	46
Durham		✓		48
Elara		✓	✓	50
Hayworth	✓	✓	✓	56
Key Grande	✓	✓		62
Key West & Key Largo	✓	✓	✓	64
Larkin 1 & 2	✓	✓	✓	68
Larkin 3 & 4 <i>NEW</i>	✓	✓	✓	69
Leyton		✓	✓	72
Loxley <i>NEW</i>	✓	✓	✓	74
Lyon	✓	✓	✓	76
Marie		✓	✓	78
Merrick		✓	✓	80
Milan 1		✓		82
Mirada		✓		84
Philip	✓	✓	✓	86
Regan		✓		89
Renzo	✓	✓	✓	90
Richard	✓	✓	✓	94
Roman	✓	✓	✓	96
Sonoma		✓		98
Southerland <i>NEW</i>	✓	✓	✓	100
Spencer	✓	✓	✓	102
Sullivan		✓		104
Sutton	✓	✓	✓	106
Tiffany	✓		✓	110
Wheeler	✓	✓	✓	112
Whitlock <i>NEW</i>	✓	✓	✓	114
Zane		✓		116

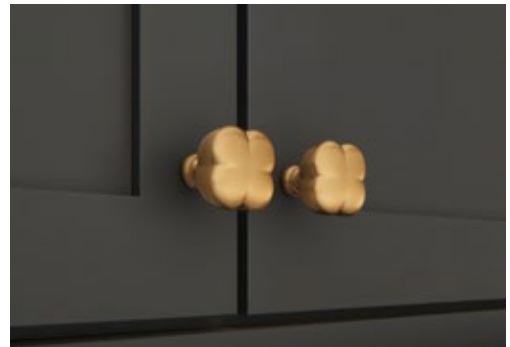

Find trending finishes in our most popular collections

ELEMENTS® by Hardware Resources

Collection	Brushed Gold (BG/ABG/MBBG)	Matte Black (MB/BLK/MBSS/MBSN)	Satin Bronze (SBZ/MBSBZ)	See Page
Asher		✓		133
Belfast		✓		134
Brenton		✓		135
Edgefield	✓	✓		140
Florence		✓	✓	142
Gibson	✓	✓	✓	144
Glendale		✓	✓	146
Hadly	✓	✓	✓	148
Hammond		✓		147
Kenner		✓		150
Knox		✓		152
Madison	✓	✓	✓	155
Merryville		✓		156
Naples	✓	✓	✓	160
Sedona		✓	✓	163
Somerset		✓	✓	165
Stanton	✓	✓	✓	166
Thatcher	✓	✓	✓	170
Torino		✓		172
Walker 1 & 2	✓	✓	✓	176
William NEW	✓	✓	✓	178
Zachary		✓		181

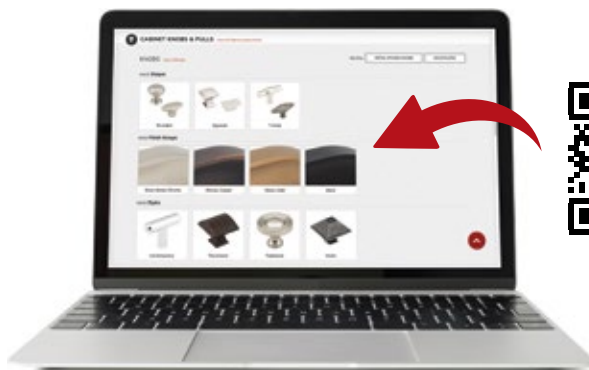

Did you know... you can shop by finish on our website?

To see how, scan the QR code or visit <https://delivr.com/sfjkr>

Relative Scale

Looking for guidance on choosing the right combination of knobs and pulls for new cabinets? We can help!

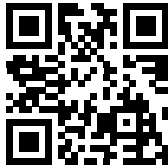

Video

<https://delivr.com/2y8d9>

Scan the QR codes to view a how-to video or download a PDF guide.



PDF

<https://delivr.com/2xfx2>

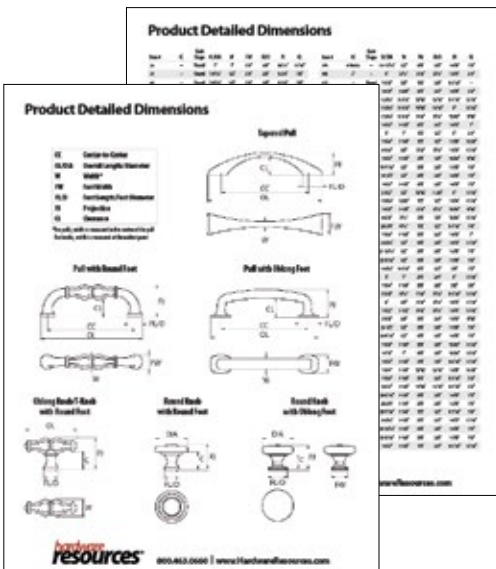

Detailed Product Dimension Guide

Detailed spec drawings and dimensions for knobs & pulls

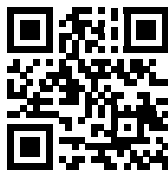

To download the PDF, scan the QR code or visit <https://delivr.com/272a7>

Finish Key

Knobs & Pulls



All brushed, antique, and distressed finishes are created by hand to add texture to the item. We hold a tight range of acceptance for color variation, however, a slight variance in the texture and tone of these items can occur. We consider these variances to be minimal; slight variations are normal.

For best results, use water and a mild soap with a soft cloth. Avoid glass cleaners, general kitchen/bathroom cleaners and other abrasive cleansers, as those cleaners could damage the finish.

Soap & Water Method:

1. Fill a bowl or sink with warm water and add a squirt of dishwashing liquid or olive-based soap. Swish the water around with your hand to make suds.
2. Dip a rag into the soapy water and wring it out.
3. Wipe the cabinet hardware with the soapy rag. For tough grime, dip a soft toothbrush into the soapy water and scrub gently.
4. Rinse the rag, wring it out, and wipe the cabinet hardware to remove the soap residue.
5. Buff the hardware with a dry chamois cloth to polish and shine it.

Vinegar Method

1. For tougher cleaning, use a solution of one part white vinegar to one part water.
2. Moisten a rag with the vinegar solution.
3. Wipe the hardware with the rag. If the rag becomes dirty, rinse the rag with water and remoisten with the vinegar solution.
4. Buff the hardware with a dry chamois cloth for a nice polish and sheen.

To reduce damage to both cabinets and hardware, use a screwdriver to hand tighten the screws to a knob or pull. Do not use a power drill or impact driver. The use of a power drill/impact driver can easily strip screw heads and overtighten hardware, causing damage to the cabinet door or drawer front.



Product Warranty

Hardware Resources believes in quality, integrity, and reliability. We uphold the highest standards of service and responsibility in the industry.

As such, Hardware Resources warrants all decorative cabinet hardware products against defects in material and workmanship as long as the original consumer purchaser owns the products, if the original consumer purchased the products from an authorized distributor of Hardware Resources. Hardware Resources cannot guarantee the quality or condition of products from distributors who do not agree to meet our high standards, and therefore, no warranty is provided for products from unauthorized sellers.

If the finish of any of these items tarnishes, corrodes, rusts, begins to chip or rub off or has any other defect, Hardware Resources will send to the original purchaser, a new replacement product of the same or comparable style and quality at no charge. If a replacement is no longer available, Hardware Resources will refund to the original purchaser, the current wholesale value of the knob or pull.

This warranty is a warranty of replacement only. Hardware Resources specifically does not warrant removal of the product nor installation of replacement new product. This warranty does not apply when the item has been tampered with, misused, improperly installed, altered from the original form, or damaged through improper cleaning, abuse or accident.

All brushed and machined finishes are created by hand to add texture to the item. We hold a tight range of acceptance for color variation, however, a slight variance in the texture and tone of these items can occur. We consider these variances to be minimal and are not considered a defect in the product.

In the unlikely event that a defective decorative cabinet hardware item is encountered, please contact Customer Service at 800.463.0660. Please be able to provide a brief description and photographs of the defect.

Bath Hardware



Elements bath hardware families Fairview, Newbury, and Bridgeport are offered in both plain white box contractor packaging and retail packaging

Contractor Packaging:

Specifically designed for builders who are simply interested in the hardware and don't need eye-catching packaging, this plain white box includes the Elements brand logo.



Retail Packaging:

Specifically designed for retail environments to appeal to the end consumer when planogrammed on the shelf. Attractive packaging with windows that showcase the product for the end consumer. Retail packaging includes a UPC code printed on the box and English, French, and Spanish translations on all packaging. Internal shrink wrap protects the product in the box from dust/external damage.

Bath Hardware

Elements

Bridgeport (BHE1)	214
Fairview (BHE5).....	215
Newbury (BHE3).....	216
Curved Shower Rods.....	217
Safety Grab Bars	218



See page 212 for warranty and care & cleaning information.

BRIDGEPORT



BHE1-01
Paper Holder with
Spring Load System



BHE1-02
Robe Hook



BHE1-06
Towel Ring



BHE1-03
Towel Bar 18"



BHE1-04
Towel Bar 24"

Contractor Pack	Retail Pack	Description	Center-to-Center	Overall Length	Finish
BHE1-01PC	BHE1-01PC-R	Paper Holder	5-13/16"	7-13/16"	Polished Chrome
BHE1-02PC	BHE1-02PC-R	Robe Hook		2-1/4"	Polished Chrome
BHE1-03PC	BHE1-03PC-R	Towel Bar	18"	20"	Polished Chrome
BHE1-04PC	BHE1-04PC-R	Towel Bar	24"	26"	Polished Chrome
BHE1-06PC	BHE1-06PC-R	Towel Ring		7-1/16"	Polished Chrome

Finish



PC
Polished Chrome

FAIRVIEW



BHE5-02
Robe Hook



BHE5-07
Euro Paper Holder



BHE5-06
Towel Ring



BHE5-01
Paper Holder with
Spring Load System



BHE5-03
Towel Bar 18"



BHE5-04
Towel Bar 24"



Contractor Pack	Retail Pack	Description	Center-to-Center	Overall Length	Finish
BHE5-01DBAC	BHE5-01DBAC-R	Paper Holder	6-1/2"	9"	Brushed Oil Rubbed Bronze
BHE5-01PC	BHE5-01PC-R	Paper Holder	6-1/2"	9"	Polished Chrome
BHE5-01SN	BHE5-01SN-R	Paper Holder	6-1/2"	9"	Satin Nickel
BHE5-02DBAC	BHE5-02DBAC-R	Robe Hook		3-3/4"	Brushed Oil Rubbed Bronze
BHE5-02PC	BHE5-02PC-R	Robe Hook		3-3/4"	Polished Chrome
BHE5-02SN	BHE5-02SN-R	Robe Hook		3-3/4"	Satin Nickel
BHE5-03DBAC	BHE5-03DBAC-R	Towel Bar	18"	20-1/2"	Brushed Oil Rubbed Bronze
BHE5-03PC	BHE5-03PC-R-R	Towel Bar	18"	20-1/2"	Polished Chrome
BHE5-03SN	BHE5-03SN	Towel Bar	18"	20-1/2"	Satin Nickel
BHE5-04DBAC	BHE5-04DBAC-R	Towel Bar	24"	26-1/2"	Brushed Oil Rubbed Bronze
BHE5-04PC	BHE5-04PC-R	Towel Bar	24"	26-1/2"	Polished Chrome
BHE5-04SN	BHE5-04SN-R	Towel Bar	24"	26-1/2"	Satin Nickel
BHE5-06DBAC	BHE5-06DBAC-R	Towel Ring		7-9/16"	Brushed Oil Rubbed Bronze
BHE5-06PC	BHE5-06PC-R	Towel Ring		7-9/16"	Polished Chrome
BHE5-06SN	BHE5-06SN-R	Towel Ring		7-9/16"	Satin Nickel
BHE5-07DBAC	BHE5-07DBAC-R	Euro Paper Holder		5-3/8"	Brushed Oil Rubbed Bronze
BHE5-07PC	BHE5-07PC-R	Euro Paper Holder		5-3/8"	Polished Chrome
BHE5-07SN	BHE5-07SN-R	Euro Paper Holder		5-3/8"	Satin Nickel

Finishes



DBAC
Brushed Oil Rubbed Bronze



PC
Polished Chrome



SN
Satin Nickel

NEWBURY



BHE3-02
Robe Hook

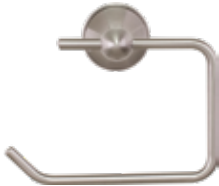

BHE3-01
Euro Paper Holder



BHE3-06
Towel Ring



BHE3-03
Towel Bar 18"



BHE3-04
Towel Bar 24"



Contractor Pack	Retail Pack	Description	Center-to-Center	Overall Length	Finish
BHE3-01DBAC	BHE3-01DBAC-R	Euro Paper Holder		5-3/8"	Brushed Oil Rubbed Bronze
BHE3-01SN	BHE3-01SN-R	Euro Paper Holder		5-3/8"	Satin Nickel
BHE3-02DBAC	BHE3-02DBAC-R	Robe Hook		2-9/16"	Brushed Oil Rubbed Bronze
BHE3-02SN	BHE3-02SN-R	Robe Hook		2-9/16"	Satin Nickel
BHE3-03DBAC	BHE3-03DBAC-R	Towel Bar	18"	19-3/4"	Brushed Oil Rubbed Bronze
BHE3-03SN	BHE3-03SN-R	Towel Bar	18"	19-3/4"	Satin Nickel
BHE3-04DBAC	BHE3-04DBAC-R	Towel Bar	24"	25-3/4"	Brushed Oil Rubbed Bronze
BHE3-04SN	BHE3-04SN-R	Towel Bar	24"	25-3/4"	Satin Nickel
BHE3-06DBAC	BHE3-06DBAC-R	Towel Ring		7-3/16"	Brushed Oil Rubbed Bronze
BHE3-06SN	BHE3-06SN-R	Towel Ring		7-3/16"	Satin Nickel

Finish



DBAC
Brushed Oil Rubbed Bronze



SN
Satin Nickel

CURVED SHOWER ROD



DBAC
Brushed Oil
Rubbed Bronze



PC
Polished Chrome



SN
Satin Nickel

Fits 60"–72" openings

Rust resistant

Increases shower space 25%

Use with any standard shower curtain

Curtain and hooks not included

Retail Pack	Description	Center-to-Center	Overall Length	Finish
SR02-DBAC-R	Curved Shower Rod	adjustable	60" - 72"	Brushed Oil Rubbed Bronze
SR02-PC-R	Curved Shower Rod	adjustable	60" - 72"	Polished Chrome
SR02-SN-R	Curved Shower Rod	adjustable	60" - 72"	Satin Nickel



SAFETY GRAB BARS

Meet strict ADA requirements



GRAB-18-R
18" Safety Grab Bar
Stainless Steel



GRAB-24-R
24" Safety Grab Bar
Stainless Steel



GRAB-36-R
36" Safety Grab Bar
Stainless Steel



GRAB-42-R
42" Safety Grab Bar
Stainless Steel



GRAB-48-R
48" Safety Grab Bar
Stainless Steel

Retail Pack	Description	Center-to-Center	Overall Length	Finish
GRAB-18-R	Safety Grab Bar	18"	21"	Stainless Steel
GRAB-24-R	Safety Grab Bar	24"	27-1/16"	Stainless Steel
GRAB-36-R	Safety Grab Bar	36"	39"	Stainless Steel
GRAB-42-R	Safety Grab Bar	42"	45-1/16"	Stainless Steel
GRAB-48-R	Safety Grab Bar	48"	51"	Stainless Steel



1-1/2" Diameter, 18/8 Stainless Steel, 3" Base Diameter, 1-1/2" Wall Clearance, Concealed Mount.
For persons up to 500 lb. Meets ADA requirements. Installation hardware and instructions included.

Decorative Hooks

A SIMPLE, YET VERSATILE PIECE OF HARDWARE FOR THE HOME THAT IS OFTEN FORGOTTEN



YD55-587DBAC shown in use. See page 220

For kitchens, baths, closets, laundry rooms, mud rooms, and many other places, Elements offers a wide array of decorative wall hooks to complement any project.

Made to Last

Manufactured from durable zinc diecast and weight tested to hold up to 35 lb.

Same Beautiful Finishes

Available in the same classic finishes as our Jeffrey Alexander and Elements decorative cabinet hardware for a cohesive look throughout the house.

Lifetime Warranty

Elements by Hardware Resources believes in quality, integrity, and reliability by offering a lifetime warranty on all of our hooks.



See page 212 for warranty and care & cleaning information.

Hooks

YD50-518	220
YD45-431	220
YD60-550	220
YD55-587	220
YT40C-400	220
YT40-400	220
YD40-450	220
YD40-337	220
YD30-381	221
YD25-256	221
YD20-156	221
YD10-231	221
YD15-187	221
YS05-175	221
YD35-556	221



YD50-518DBAC



YD45-431PC



YD60-550SN



YD55-587SN

Item	Width	Height	Projection	Inner Box	Finishes
YD50-518	1-3/8"	5-3/16"	2-7/16"	20	DBAC, PC, SN
YD45-431	1-3/4"	4-5/16"	2-3/4"	20	DBAC, PC, SN
YD60-550	1-1/2"	5-1/2"	3-1/4"	20	DBAC, PC, SN
YD55-587	1-1/2"	5-7/8"	2-1/2"	20	DBAC, PC, SN

Two 1-1/8" installation screws included



YT40C-400DBAC



YT40-400PC



YD40-450DBAC



YD40-337PC

Item	Width	Height	Projection	Inner Box	Finishes
YT40C-400	2-3/4"	4"	2-3/8"	20	DBAC, PC, SN
YT40-400	2-11/16"	4"	2-1/4"	20	DBAC, PC, SN
YD40-450	1"	4-1/2"	3-9/16"	20	DBAC, PC, SN
YD40-337	13/16"	3-3/8"	2-3/8"	20	DBAC, PC, SN

Two 1-1/8" installation screws included

Finishes Available:

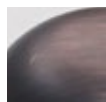

(DBAC)
Brushed Oil
Rubbed Bronze



(PC)
Polished
Chrome



(SN)
Satin Nickel



(PSS)
Polished
Stainless



(SS)
Brushed
Stainless



YD30-381DBAC



YD25-256PC



YD20-156SN



YD10-231PC

Item	Width	Height	Projection	Inner Box	Finishes
YD30-381	1-7/16"	3-9/16"	2-15/16"	20	DBAC, PC, SN
YD25-256	2-15/16"	2-9/16"	1-3/8"	20	DBAC, PC, SN
YD20-156	3"	1-1/2"	2"	20	DBAC, PC, SN
YD10-231	1-1/16"	2-5/16"	2-3/4"	20	DBAC, PC, SN

Two 1-1/8" installation screws included



YD15-187DBAC



YS05-175SN



YD35-556SS

Item	Width	Height	Projection	Inner Box	Finishes
YD15-187	2-13/16"	1-7/8"	1"	20	DBAC, PC, SN
YS05-175*	1"	1-3/4"	1-3/4"	20	DBAC, PC, SN
YD35-556	13/16"	5-9/16"	2-5/8"	20	PSS, SS

Two 1-1/8" installation screws included

*Two 1" installation screws included

Detailed Product Dimensions

Detailed spec drawings and dimensions for hooks

To download the PDF,
scan the QR code or visit
<http://delivr.com/2wb5z>



Bath Vanities

TABLE OF CONTENTS



VANITY & TOP SPECIFICATION DRAWINGS



Specification drawings can be downloaded by scanning the QR code or visiting: <https://delivr.com/2qs6a>

ORDERING	225
VANITY INDEX.....	226–227
PREMIUM FEATURES	228
PART NUMBER KEY	229
WARRANTY.....	229
COLLECTIONS	
GARDNER COMING EARLY 2024	230–233
TEMPEST COMING EARLY 2024	234–237
CADE	238–241
CHATHAM	242–245
DASHWOOD NEW COLLECTION	246–249
JUBILEE NEW COLLECTION	250–253
KATARA	254–257
KIPLING COMING EARLY 2024	258–259
PASCAL NEW COLLECTION	260–263
PERCIVAL	264–265
THEODORA	266–269
WAVECREST	270–273
ASTORIA RETIRED	274–275
SAVINO RETIRED	276–277
VANITY NIGHT LIGHT KIT.....	279
TOP & BOWL INFORMATION	
VANITY TOP OVERVIEW.....	280
BOWLS.....	280
VANITY TOP MATERIALS NEW MATERIALS	281–283
MIRRORS NEW MIRRORS & FINISHES	284–286
RESOURCES	287
FINISH KEY	288

THE POWER OF SELECTION

We understand that when it comes to creating a perfectly personalized space, options are of utmost importance. You now have the power to select the ideal vanity configuration that fits your client's style. Simply choose the style of vanity, vanity top, and bowl shape to complete a look that they'll love. **There are over 4,000 possible combinations!**



The Pascal Collection is featured above to showcase the wide variety of combinations available.

Vanity styles range from classical to sleek and airy. **Multiple top options in Quartz, Natural Stone, and Engineered Materials are available in all sizes.** Color choices range from deep, complex shades to medium, neutral tones to light and tranquil hues. Each vanity top is crafted with care and most are available with either an oval or rectangle bowl cutout.

All vanities, vanity tops, bowls, and mirrors are stocked in our centrally-located warehouse.

Orders typically ship within 24 hours.

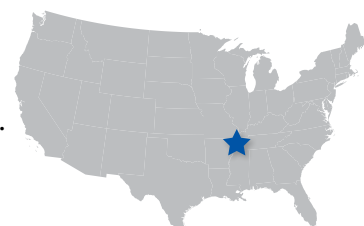

ORDERING MADE EASY



STEP 1

Select a vanity style

- Begin creating the ideal vanity by choosing from our many collections with a wide variety of sizes and trending finishes
- Pages 230–277



STEP 2

Select a vanity top color & material

- Choose from multiple different top colors in 3 types of material
- Matching backsplash included (except White Stone Resin)
- Pages 281–283

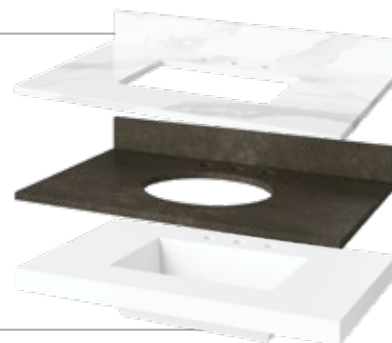

STEP 3

Select a bowl

- Choose a rectangle or oval bowl; available for most vanity tops (White Stone Resin and White Quartz are only available in rectangle)
- Page 280



STEP 4

Select a mirror

- Choose a coordinating mirror to create the ideal bathroom space
- Pages 284–286



COMPLETE THE LOOK

- Sidesplashes are available and will work on either side of the vanity top (see page 283 for more information)
- Check out our complementary product lines: Knobs & Pulls (7–212), Cabinets (601–636), and Lighting (493–600)

Faucet not included with vanity purchase. Top and bowl assembly required.



**Ask about our
Vanity Display
Program!**

When purchased together, all products (vanity, top, bowl, sidesplash, and mirror) will be individually packaged, secured, and shipped together on a pallet.

To place an order, call customer service at 1-800-463-0660, or place an order online at www.JeffreyAlexanderVanities.com.

COMING EARLY 2024

GARDNER

For a complete list of sizes & finish options see pages 230-233



30" BLUE STEEL
VN2GAR-30-BS-NT



36" DARK WALNUT
VN2GAR-36-DW-NT & VNLEGWD36DW



48" WHITE
VN2GAR-48-WH-NT & VNLEGPENS

COMING EARLY 2024

TEMPEST

For a complete list of sizes & finish options see pages 234-237



30" NATURAL OAK
VN2TEM-30-NO-NT



36" BLUE STEEL
VN2TEM-36-BS-NT & VNLEGWD36BS



48" DARK WALNUT
VN2TEM-48-DW-NT & VNLEGSQ48

CADE

For a complete list of sizes & finish options see pages 238-241



18" GREY
VN2CAD-18-GR-NT



24" WHITE
VN2CAD-24-WH-NT



30" BLACK
VN2CAD-30-BK-NT



36" FOREST GREEN
VN2CAD-36-GN-NT



48" HALE BLUE
VN2CAD-48-BL-NT



60" GREY DOUBLE BOWL
VN2CAD-60-GR-NT

CHATHAM

For a complete list of sizes & finish options see pages 242-245



NEW
18" HALE BLUE
VN2CHA-18-BL-NT



24" GREY
VN2CHA-24-GR-NT



30" FOREST GREEN
VN2CHA-30-GN-NT



36" WHITE
VN2CHA-36-WH-NT



48" HALE BLUE
VN2CHA-48-BL-NT



60" CHOCOLATE SINGLE BOWL
VN2CHA-60SCH-NT



60" GREY DOUBLE BOWL
VN2CHA-60-GR-NT

NEW

DASHWOOD

For a complete list of sizes & finish options see pages 246-249



24" DARK WALNUT
VN2DAS-24-DW-NT



30" BLUE STEEL
VN2DAS-30-BS-NT



36" NATURAL OAK
VN2DAS-36-NO-NT



42" WHITE
VN2DAS-42-WH-NT



48" DARK WALNUT
VN2DAS-48-DW-NT



60" NATURAL OAK DOUBLE BOWL
VN2DAS-60-NO-NT

NEW

JUBILEE

For a complete list of sizes & finish options see pages 250-253



24" DARK WALNUT
VN2JUB-24-DW-NT



30" GREY
VN2JUB-30-GR-NT



36" NATURAL OAK
VN2JUB-36-NO-NT



42" WEATHERED GREY
VN2JUB-42-WG-NT



48" WHITE
VN2JUB-48-WH-NT



60" DARK WALNUT DOUBLE BOWL
VN2JUB-60-DW-NT

KATARA

For a complete list of sizes & finish options see pages 254-257



24" BLACK
VN2KAT-24-BK-NT



30" HALE BLUE
VN2KAT-30-BL-NT



36" FOREST GREEN
VN2KAT-36-GN-NT



42" GREY
VN2KAT-42-GR-NT



48" BLUE STEEL
VN2KAT-48-BS-NT



60" WHITE DOUBLE BOWL
VN2KAT-60-WH-NT

VANITY INDEX

COMING EARLY 2024

KIPLING

For a complete list of sizes & finish options see pages 258-259



30" BLACK
VNKIP-30-BK-NT



36" DARK WALNUT
VNKIP-36-DW-NT



48" NATURAL OAK
VNKIP-48-NO-NT



60" WHITE DOUBLE BOWL
VNKIP-60-WH-NT

NEW

PASCAL

For a complete list of sizes & finish options see pages 260-263



24" DARK WALNUT
VN2PAS-24-DW-NT



30" BLUE STEEL
VN2PAS-30-BS-NT



36" GREY
VN2PAS-36-GR-NT



42" NATURAL OAK
VN2PAS-42-NO-NT



48" WEATHERED GREY
VN2PAS-48-WG-NT



60" WHITE DOUBLE BOWL
VN2PAS-60-WH-NT

PERCIVAL

For a complete list of sizes & finish options see pages 264-265



24" GREY
VN2PER-24-GR-NT



30" WHITE
VN2PER-30-WH-NT



36" BLACK
VN2PER-36-BK-NT

THEODORA

For a complete list of sizes & finish options see pages 266-269



24" BLUE STEEL
VN2THE-24-BS-NT



30" WHITE
VN2THE-30-WH-NT



36" FOREST GREEN
VN2THE-36-GN-NT



48" GREY
VN2THE-48-GR-NT



60" BLACK DOUBLE BOWL
VN2THE-60-BK-NT

WAVECREST

For a complete list of sizes & finish options see pages 270-273



24" GREY
VN2WAV-24-GR-NT



30" FOREST GREEN
VN2WAV-30-GN-NT



36" WHITE
VN2WAV-36-WH-NT



48" HALE BLUE
VN2WAV-48-BL-NT



**60" WEATHERED GREY
DOUBLE BOWL**
VN2WAV-60-WG-NT

RETIRED

ASTORIA

For a complete list of sizes & finish options see pages 274-275



24" GREY
VN2AST-24-GR-NT



30" WHITE
VN2AST-30-WH-NT



36" ESPRESSO
VN2AST-36-ES-NT



48" GREY
VN2AST-48-GR-NT

RETIRED

SAVINO

For a complete list of sizes & finish options see pages 276-277



24" GREY
VN2SAV-24-GR-NT



30" WHITE
VN2SAV-30-WH-NT



36" GREY
VN2SAV-36-GR-NT



48" WHITE
VN2SAV-48-WH-NT



60" GREY DOUBLE BOWL
VN2SAV-60-GR-NT

PREMIUM FEATURES

JEFFREY ALEXANDER VANITIES



Furniture-Style Hardwood Construction

- Solid hardwood frame and furniture-grade plywood

Soft-Close EVERYTHING

- Hardware Resources full-extension, soft-close undermount drawer slides
- Hardware Resources soft-close hinges

Maximum Storage

- Adjustable shelves (not shown)
- Rollout drawers
- Custom hardwood tipout trays; no false-front drawers

Dovetail Hardwood Drawer Boxes

- Expertly crafted components for ultimate durability

ALL OF OUR VANITIES FEATURE:



Safety Compliant Material

All wood is compliant with CARB2/TSCA Title VI safety standards



Lifetime Warranty

Lifetime warranty for the original purchaser



Popular Styles and Finishes



Enhanced Packaging

Extra padding and supports protect against damage in shipping



To learn more about our vanity quality features, scan the QR code or visit <http://delivr.com/2y92a>



To learn more about our enhanced packaging, scan the QR code or visit <http://delivr.com/2dgrv>

VANITY PART NUMBER KEY

Example (60" Grey Katara Vanity with No Top):

VN2KAT-60-GR-NT

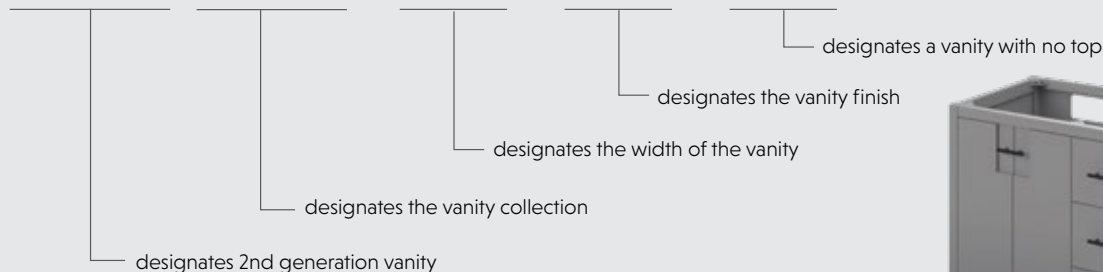

CODE ABBREVIATIONS

AST	Astoria	18	18" vanity	BK	Black
CAD	Cade	24	24" vanity	BL	Hale Blue
CHA	Chatham	30	30" vanity	BS	Blue Steel
DAS	Dashwood	36	36" vanity	CH	Chocolate
GAR	Gardner	42	42" vanity	DW	Dark Walnut
JUB	Jubilee	48	48" vanity	ES	Espresso
KAT	Katara	60	60" vanity (double bowl)	GN	Forest Green
KIP	Kipling	60S	60" vanity (single bowl)	GR	Grey
PAS	Pascal			NO	Natural Oak
PER	Percival			WG	Weathered Grey
SAV	Savino			WH	White
TEM	Tempest				
THE	Theodora				
WAV	Wavecrest				



Vanity Finish Swatch Kits

Jeffrey Alexander finish swatch kits are available from your sales representative.

SKU: VNSWATCH-KIT



Product Warranty

Hardware Resources believes in quality, integrity, and reliability. We uphold the highest standards of service and responsibility in the industry.

As such, Hardware Resources warrants all vanities, mirrors, vanity tops, bowls, and their components to be free from any defects in material and workmanship as long as the original consumer/purchaser owns the products and if the original consumer purchased the products from an authorized distributor of Hardware Resources. Hardware Resources cannot guarantee the quality or condition of products from distributors who do not agree to meet our high standards, and therefore, no warranty is provided for products from unauthorized sellers.

If a defect is found, Hardware Resources will send to the original purchaser a new replacement product or component at no charge. If a replacement is no longer available, Hardware Resources will offer a product that is comparable to the original product's purchased price or will refund to the original purchaser the current wholesale value of the defective product or component. This warranty is a warranty of replacement only. Hardware Resources specifically does not warrant removal of the product nor installation of replacement new product.

This warranty does not apply when the item has been tampered with, misused, improperly installed, altered from the original design, or damaged through abuse or accident. Finishes for all vanities and mirrors are multi-layered, therefore, variations may occur, which add to the uniqueness of each item.

Natural stone countertops possess naturally occurring characteristics such as variations in grain and color as well as mineral streaks and deposits and are not considered a defect in the product. Cultured marble and quartz countertops are manufactured to resemble natural stone patterns, and as a result, variations in grain and color are not considered a defect in the product. Exact shading or grain of the vanity top cannot be guaranteed.

In the unlikely event that a defective vanity, mirror, vanity top, or component is encountered, please contact Customer Service at 800.463.0660. Please be able to provide a brief description and photographs of the defect.



Gardner Collection

Vanity: VN2GAR-48-NO-NT | Top: TOPR4919RE-1 | Mirror: VMIR-METC-30MB

COMING EARLY 2024

NEW

**Bath
Vanities**

GARDNER COLLECTION

When contemporary living demands innovation, the Gardner floating vanity collection by Jeffrey Alexander emerges as the ideal choice. Gardner is a symphony of sleek design and purposeful functionality with the clean lines of slab drawer fronts and minimalistic tab pulls, harmonized by large drawers for storage that boast sturdy dovetail joinery. Gardner's 18" depth is optimized to provide ample room for all bathroom essentials while maintaining a compact and space-efficient footprint.

Transform the Gardner floating vanity into a free-standing furniture-style vanity by adding any of our three distinct leg options. Opt for the mid-century allure of matte black steel pencil legs, embrace the modern-industrial vibe with the 1-1/2" matte black square steel frame, or maintain a sleek coherence with a coordinating wood frame that elegantly complements the vanity. For available mirrors, please see pages 284–286.



Gardner Collection

Vanity: VN2GAR-48-NO-NT | Legs: VNLEGPEN5 | Top: TOPR4919RE-1 | Mirror: VMIR-METC-30MB

PREMIUM FEATURES

- 18" depth for small spaces
- Three different leg styles to create individualized free-standing vanity options
- Premium undermount drawer slides feature soft-close and full-extension opening
- Hardwood drawers with strong & beautiful dovetail joinery
- Hardwood tipout trays replace false-front drawers beneath the sink
- Durable furniture-style wood construction
- Lifetime warranty for original purchaser



GARDNER COLLECTION

COMING EARLY 2024

AVAILABLE FINISHES



(WH)
White



(BS)
Blue Steel



NEW (DW)
Dark Walnut



NEW (NO)
Natural Oak

VANITY OPTIONS

Vanities can be mounted directly to the wall for a floating application



VN2GAR-30-WH-NT
White Stone Resin top sold separately.

30" VANITY

FINISH	VANITY	HARDWARE	MIRROR OPTIONS
White	VN2GAR-30-WH-NT 30" x 21-1/2" x 35"	Matte Black	24" or 28" wide See pages 284-286
Blue Steel	VN2GAR-30-BS-NT 30" x 21-1/2" x 35"	Matte Black	24" or 28" wide See pages 284-286
Dark Walnut	VN2GAR-30-DW-NT 30" x 21-1/2" x 35"	Matte Black	24" or 28" wide See pages 284-286
Natural Oak	VN2GAR-30-NO-NT 30" x 21-1/2" x 35"	Matte Black	24" or 28" wide See pages 284-286



VN2GAR-36-BS-NT
White Stone Resin top sold separately.

36" VANITY

FINISH	VANITY	HARDWARE	MIRROR OPTIONS
White	VN2GAR-36-WH-NT 36" x 21-1/2" x 35"	Matte Black	33" or smaller See pages 284-286
Blue Steel	VN2GAR-36-BS-NT 36" x 21-1/2" x 35"	Matte Black	33" or smaller See pages 284-286
Dark Walnut	VN2GAR-36-DW-NT 36" x 21-1/2" x 35"	Matte Black	33" or smaller See pages 284-286
Natural Oak	VN2GAR-36-NO-NT 36" x 21-1/2" x 35"	Matte Black	33" or smaller See pages 284-286



VN2GAR-48-DW-NT
White Stone Resin top sold separately.

48" VANITY

FINISH	VANITY	HARDWARE	MIRROR OPTIONS
White	VN2GAR-48-WH-NT 48" x 21-1/2" x 35"	Matte Black	33", 40" or 42" wide See pages 284-286
Blue Steel	VN2GAR-48-BS-NT 48" x 21-1/2" x 35"	Matte Black	33", 40" or 42" wide See pages 284-286
Dark Walnut	VN2GAR-48-DW-NT 48" x 21-1/2" x 35"	Matte Black	33", 40" or 42" wide See pages 284-286
Natural Oak	VN2GAR-48-NO-NT 48" x 21-1/2" x 35"	Matte Black	33", 40" or 42" wide See pages 284-286



Watch this video to learn about
wall-mounting and leg installation.
Scan the QR Code or visit
<http://delivr.com/2c5ve>



Care should be taken when installing floating vanities.
Please follow the instructions and mount the vanities to
a properly installed header board for safety and stability.

LEG OPTIONS

Transform a floating vanity into a free-standing furniture-style vanity by adding any of our three distinct leg options.

Vanity: VN2GAR-30-NO-NT
Legs: VNLEGWD30NO
Top: TOPR3119RE-1



Vanity: VN2GAR-30-DW-NT
Legs: VNLEGPEN4
Top: TOPR3119RE-1



WOOD LEGS

FINISH	SKU	DIMENSIONS	VANITY SIZE
White	VNLEGWD30WH	29-7/8" W x 18-3/8" D x 13" H	30"
White	VNLEGWD36WH	35-7/8" W x 18-3/8" D x 13" H	36"
White	VNLEGWD48WH	47-7/8" W x 18-3/8" D x 13" H	48"
Blue Steel	VNLEGWD30BS	29-7/8" W x 18-3/8" D x 13" H	30"
Blue Steel	VNLEGWD36BS	35-7/8" W x 18-3/8" D x 13" H	36"
Blue Steel	VNLEGWD48BS	47-7/8" W x 18-3/8" D x 13" H	48"
Dark Walnut	VNLEGWD30DW	29-7/8" W x 18-3/8" D x 13" H	30"
Dark Walnut	VNLEGWD36DW	35-7/8" W x 18-3/8" D x 13" H	36"
Dark Walnut	VNLEGWD48DW	47-7/8" W x 18-3/8" D x 13" H	48"
Natural Oak	VNLEGWD30NO	29-7/8" W x 18-3/8" D x 13" H	30"
Natural Oak	VNLEGWD36NO	35-7/8" W x 18-3/8" D x 13" H	36"
Natural Oak	VNLEGWD48NO	47-7/8" W x 18-3/8" D x 13" H	48"

METAL PENCIL LEGS

FINISH	SKU	DIMENSIONS	VANITY SIZE
Matte Black	VNLEGPEN4	1-1/2" W x 13"H (top) 3/4" W x 13" H (bottom)	30" & 36"
Matte Black	VNLEGPEN5	1-1/2" W x 13"H (top) 3/4" W x 13" H (bottom)	48"

Vanity: VN2GAR-30-BS-NT
Legs: VNLEGSQ30
Top: TOPR3119RE-1



SQUARE STEEL FRAME LEGS

FINISH	SKU	DIMENSIONS	VANITY SIZE
Matte Black	VNLEGSQ30	29-7/8" W x 18-3/8" D x 13" H	30"
Matte Black	VNLEGSQ36	35-7/8" W x 18-3/8" D x 13" H	36"
Matte Black	VNLEGSQ48	47-7/8" W x 18-3/8" D x 13" H	48"

ADD A TOP

Coordinating tops are available in glossy White Stone Resin



FINISH	SKU	DIMENSIONS	VANITY SIZE
White Stone Resin	TOPR3119RE-1	31" x 19" x 2-1/2"	30"
White Stone Resin	TOPR3719RE-1	37" x 19" x 2-1/2"	36"
White Stone Resin	TOPR4919RE-1	49" x 19" x 2-1/2"	48"



Design Idea—Mix it Up

For a trendy look that will make the vanity the focal point of the bathroom, mix and match vanity and leg finishes. Try a Dark Walnut vanity with White legs, or a Blue Steel vanity with Dark Walnut legs.

WHERE CAN I FIND THAT HARDWARE?

The decorative hardware included on this vanity is from the Edgefield Collection. Find it in the Knobs & Pulls section of this catalog on page 140.



Tempest Collection

Vanity: VN2TEM-48-BS-NT | Top: TOPR4919RE-1 | Mirror: VMIR-METR-33MB

COMING EARLY 2024

NEW

TEMPEST

COLLECTION

Create a moody, atmospheric space with Jeffrey Alexander's Tempest floating vanity collection. The sensation of spaciousness that Tempest's 18" depth offers enhances the bathroom's space and seamlessly integrates storage. Sleek doors are adorned with Jeffrey Alexander's Dominique pulls, adding to this collection's luxurious allure.

Transform the Tempest floating vanity into a free-standing furniture-style vanity by adding any of our three distinct leg options. Opt for the mid-century allure of matte black steel pencil legs, embrace the modern-industrial vibe with the 1-1/2" matte black square steel frame, or maintain a sleek coherence with a coordinating wood frame that elegantly complements the vanity. For available mirrors, please see pages 284–286.



PREMIUM FEATURES

- 18" depth for small spaces
- Three different leg styles to create individualized free-standing vanity options
- Premium undermount drawer slides feature soft-close and full-extension opening
- Hardwood drawers with strong & beautiful dovetail joinery
- Hardwood tipout trays replace false-front drawers beneath the sink
- Durable furniture-style wood construction
- Lifetime warranty for original purchaser



TEMPEST COLLECTION

COMING EARLY 2024

AVAILABLE FINISHES



(WH)
White



(BS)
Blue Steel



NEW (DW)
Dark Walnut

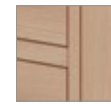

NEW (NO)
Natural Oak

VANITY OPTIONS

Vanities can be mounted directly to the wall for a floating application



VN2TEM-30-WH-NT
White Stone Resin top sold separately.

30" VANITY

FINISH	VANITY	HARDWARE	MIRROR OPTIONS
White	VN2TEM-30-WH-NT 30" x 21-1/2" x 35"	Matte Black	24" or 28" wide See pages 284–286
Blue Steel	VN2TEM-30-BS-NT 30" x 21-1/2" x 35"	Matte Black	24" or 28" wide See pages 284–286
Dark Walnut	VN2TEM-30-DW-NT 30" x 21-1/2" x 35"	Matte Black	24" or 28" wide See pages 284–286
Natural Oak	VN2TEM-30-NO-NT 30" x 21-1/2" x 35"	Matte Black	24" or 28" wide See pages 284–286



VN2TEM-36-BS-NT
White Stone Resin top sold separately.

36" VANITY

FINISH	VANITY	HARDWARE	MIRROR OPTIONS
White	VN2TEM-36-WH-NT 36" x 21-1/2" x 35"	Matte Black	33" or smaller See pages 284–286
Blue Steel	VN2TEM-36-BS-NT 36" x 21-1/2" x 35"	Matte Black	33" or smaller See pages 284–286
Dark Walnut	VN2TEM-36-DW-NT 36" x 21-1/2" x 35"	Matte Black	33" or smaller See pages 284–286
Natural Oak	VN2TEM-36-NO-NT 36" x 21-1/2" x 35"	Matte Black	33" or smaller See pages 284–286



VN2TEM-48-DW-NT
White Stone Resin top sold separately.

48" VANITY

FINISH	VANITY	HARDWARE	MIRROR OPTIONS
White	VN2TEM-48-WH-NT 48" x 21-1/2" x 35"	Matte Black	33", 40" or 42" wide See pages 284–286
Blue Steel	VN2TEM-48-BS-NT 48" x 21-1/2" x 35"	Matte Black	33", 40" or 42" wide See pages 284–286
Dark Walnut	VN2TEM-48-DW-NT 48" x 21-1/2" x 35"	Matte Black	33", 40" or 42" wide See pages 284–286
Natural Oak	VN2TEM-48-NO-NT 48" x 21-1/2" x 35"	Matte Black	33", 40" or 42" wide See pages 284–286



**Watch this video to learn about
wall-mounting and leg installation.**
Scan the QR Code or visit
<http://delivr.com/2c5ve>



Care should be taken when installing floating vanities. Please follow the instructions and mount the vanities to a properly installed header board for safety and stability.

LEG OPTIONS

Transform a floating vanity into a free-standing furniture-style vanity by adding any of our three distinct leg options.

Vanity: VN2TEM-30-NO-NT
Legs: VNLEGWD30NO
Top: TOPR3119RE-1



Vanity: VN2TEM-30-BS-NT
Legs: VNLEGSQ30
Top: TOPR3119RE-1



WOOD LEGS

FINISH	SKU	DIMENSIONS	VANITY SIZE
White	VNLEGWD30WH	29-7/8" W x 18-3/8" D x 13" H	30"
White	VNLEGWD36WH	35-7/8" W x 18-3/8" D x 13" H	36"
White	VNLEGWD48WH	47-7/8" W x 18-3/8" D x 13" H	48"
Blue Steel	VNLEGWD30BS	29-7/8" W x 18-3/8" D x 13" H	30"
Blue Steel	VNLEGWD36BS	35-7/8" W x 18-3/8" D x 13" H	36"
Blue Steel	VNLEGWD48BS	47-7/8" W x 18-3/8" D x 13" H	48"
Dark Walnut	VNLEGWD30DW	29-7/8" W x 18-3/8" D x 13" H	30"
Dark Walnut	VNLEGWD36DW	35-7/8" W x 18-3/8" D x 13" H	36"
Dark Walnut	VNLEGWD48DW	47-7/8" W x 18-3/8" D x 13" H	48"
Natural Oak	VNLEGWD30NO	29-7/8" W x 18-3/8" D x 13" H	30"
Natural Oak	VNLEGWD36NO	35-7/8" W x 18-3/8" D x 13" H	36"
Natural Oak	VNLEGWD48NO	47-7/8" W x 18-3/8" D x 13" H	48"

METAL PENCIL LEGS

FINISH	SKU	DIMENSIONS	VANITY SIZE
Matte Black	VNLEGPEN4	1-1/2" W x 13"H (top) 3/4" W x 13" H (bottom)	30" & 36"
Matte Black	VNLEGPEN5	1-1/2" W x 13"H (top) 3/4" W x 13" H (bottom)	48"

Vanity: VN2TEM-30-DW-NT
Legs: VNLEGPEN4
Top: TOPR3119RE-1



SQUARE STEEL FRAME LEGS

FINISH	SKU	DIMENSIONS	VANITY SIZE
Matte Black	VNLEGSQ30	29-7/8" W x 18-3/8" D x 13" H	30"
Matte Black	VNLEGSQ36	35-7/8" W x 18-3/8" D x 13" H	36"
Matte Black	VNLEGSQ48	47-7/8" W x 18-3/8" D x 13" H	48"

ADD A TOP

Coordinating tops are available in glossy White Stone Resin



FINISH	SKU	DIMENSIONS	VANITY SIZE
White Stone Resin	TOPR3119RE-1	31" x 19" x 2-1/2"	30"
White Stone Resin	TOPR3719RE-1	37" x 19" x 2-1/2"	36"
White Stone Resin	TOPR4919RE-1	49" x 19" x 2-1/2"	48"



Design Idea—Mix it Up

For a trendy look that will make the vanity the focal point of the bathroom, mix and match vanity and leg finishes. Try a Natural Oak vanity with White legs, or a Blue Steel vanity with Dark Walnut legs.

WHERE CAN I FIND THAT HARDWARE?



The decorative hardware included on this vanity is from the Dominique Collection. Find it in the Knobs & Pulls section of this catalog on page 46.



Cade Collection

Vanity: VN2CAD-36-BL-NT | Top: TOPR37WCCAD-ADD

Bowl: VN2-RECT-19 | Mirror: MIR2CAD-33-BL

CADE COLLECTION

Sleek lines and raised panels come together to create a unique design for the sophisticated Cade Vanity Collection. Contemporary Stanton pulls adorn this vanity collection, adding elegance and class. Cade's design styles merge to create a perfectly transitional vanity collection. With a myriad of finishes, this vanity complements any bathroom with the perfect touch. For available mirrors, please see pages 284–286.



PREMIUM FEATURES

- Premium undermount drawer slides feature soft-close and full-extension opening
- Hardwood drawers with strong & beautiful dovetail joinery
- Durable furniture-style wood construction
- Select from Jeffrey Alexander's top & bowl options to complete your design
- Lifetime warranty for original purchaser



CADE COLLECTION

See pages 280–283 for available top & bowl options

AVAILABLE FINISHES



(WH)
White



(GR)
Grey



(BK)
Black



(BL)
Hale Blue

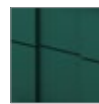

(GN)
Forest Green

18" VANITY



VN2CAD-18-WH-NT

FINISH	VANITY	HARDWARE	MIRROR OPTION
Grey	VN2CAD-18-GR-PO* 17-3/8" x 13-1/2" x 36"	Polished Chrome	16" wide See pages 284–286
Grey	VN2CAD-18-GR-NT** 18" x 13" x 33-1/2"	Polished Chrome	16" wide See pages 284–286
White	VN2CAD-18-WH-NT** 18" x 13" x 33-1/2"	Polished Chrome	16" wide See pages 284–286

*This vanity is pre-assembled with the white porcelain vessel top. Call for availability.
**White Stone Resin top available only.

24" VANITY



VN2CAD-24-GR-NT

FINISH	VANITY	HARDWARE	MIRROR OPTIONS
Black	VN2CAD-24-BK-NT 24" x 21-1/2" x 35"	Polished Chrome	22" or 24" wide See pages 284–286
Grey	VN2CAD-24-GR-NT 24" x 21-1/2" x 35"	Polished Chrome	22" or 24" wide See pages 284–286
White	VN2CAD-24-WH-NT 24" x 21-1/2" x 35"	Polished Chrome	22" or 24" wide See pages 284–286

30" VANITY



VN2CAD-30-BK-NT

FINISH	VANITY	HARDWARE	MIRROR OPTIONS
Black	VN2CAD-30-BK-NT 30" x 21-1/2" x 35"	Polished Chrome	24" or 28" wide See pages 284–286
Grey	VN2CAD-30-GR-NT 30" x 21-1/2" x 35"	Polished Chrome	24" or 28" wide See pages 284–286
White	VN2CAD-30-WH-NT 30" x 21-1/2" x 35"	Polished Chrome	24" or 28" wide See pages 284–286

36" VANITY



VN2CAD-36-GN-NT

FINISH	VANITY	HARDWARE	MIRROR OPTIONS
Black	VN2CAD-36-BK-NT 36" x 21-1/2" x 35"	Polished Chrome	33" or smaller See pages 284-286
Grey	VN2CAD-36-GR-NT 36" x 21-1/2" x 35"	Polished Chrome	33" or smaller See pages 284-286
White	VN2CAD-36-WH-NT 36" x 21-1/2" x 35"	Polished Chrome	33" or smaller See pages 284-286
Hale Blue	VN2CAD-36-BL-NT 36" x 21-1/2" x 35"	Satin Bronze	33" or smaller See pages 284-286
Forest Green	VN2CAD-36-GN-NT 36" x 21-1/2" x 35"	Satin Bronze	33" or smaller See pages 284-286

This vanity has a left offset bowl and requires a 37" top ending in CAD-ADD

48" VANITY



VN2CAD-48-BL-NT

FINISH	VANITY	HARDWARE	MIRROR OPTIONS
Black	VN2CAD-48-BK-NT 48" x 21-1/2" x 35"	Polished Chrome	33" or 40" wide See pages 284-286
Grey	VN2CAD-48-GR-NT 48" x 21-1/2" x 35"	Polished Chrome	33" or 40" wide See pages 284-286
White	VN2CAD-48-WH-NT 48" x 21-1/2" x 35"	Polished Chrome	33" or 40" wide See pages 284-286
Hale Blue	VN2CAD-48-BL-NT 48" x 21-1/2" x 35"	Satin Bronze	33" or 40" wide See pages 284-286

60" VANITY DOUBLE BOWL



VN2CAD-60-BK-NT

FINISH	VANITY	HARDWARE	MIRROR OPTIONS
Black	VN2CAD-60-BK-NT 60" x 21-1/2" x 35"	Polished Chrome	22" or 24" wide See pages 284-286
Grey	VN2CAD-60-GR-NT 60" x 21-1/2" x 35"	Polished Chrome	22" or 24" wide See pages 284-286
White	VN2CAD-60-WH-NT 60" x 21-1/2" x 35"	Polished Chrome	22" or 24" wide See pages 284-286

WHERE CAN I FIND THAT HARDWARE?



The decorative hardware included on this vanity is from the Stanton Collection. Find it in the Knobs & Pulls section of this catalog on page 166.

**Bath
Vanities**



Chatham Collection
Vanity: VN2CHA-36-WH-NT | Top: TOPO37MG
Bowl: VN2-OVAL-15 | Mirror: MIR2CHA-28-WH

CHATHAM

COLLECTION

The Chatham Vanity Collection embraces the classic Shaker style with refined elegance. Our popular Chatham collection is available in a diverse selection of colors and sizes that provides a variety of options. For available mirrors, please see pages 284–286.



Chatham Collection

Vanity: VN2CHA-60-GR-NT | Top: TOPO61WC
Bowl: VN2-OVAL-15 | Mirror: MIR2CHA-40-GR

PREMIUM FEATURES

- Premium undermount drawer slides feature soft-close and full-extension opening
- Hardwood drawers with strong & beautiful dovetail joinery
- Hardwood tipout trays replace false-front drawers beneath the sink
- Durable furniture-style wood construction
- Select from Jeffrey Alexander's top & bowl options to complete your design
- Lifetime warranty for original purchaser



CHATHAM COLLECTION

See pages 280–283 for available top & bowl options

AVAILABLE FINISHES



(WH)
White



(GR)
Grey



(CH)
Chocolate



(BL)
Hale Blue

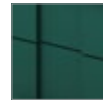

(GN)
Forest Green



(BS)
Blue Steel
NEW

18" VANITY



VN2CHA-18-GR-NT

FINISH	VANITY	HARDWARE	MIRROR OPTIONS
NEW Grey	VN2CHA-18-GR-NT 18" x 13" x 33-1/2"	Satin Nickel	16" wide See pages 284–286
NEW White	VN2CHA-18-WH-NT 18" x 13" x 33-1/2"	Satin Nickel	16" wide See pages 284–286
NEW Hale Blue	VN2CHA-18-BL-NT 18" x 13" x 33-1/2"	Satin Bronze	16" wide See pages 284–286

White Stone Resin top available only.

24" VANITY



VN2CHA-24-WH-NT

FINISH	VANITY	HARDWARE	MIRROR OPTIONS
Chocolate	VN2CHA-24-CH-NT 24" x 21-1/2" x 35"	Satin Nickel	22" or 24" wide See pages 284–286
Grey	VN2CHA-24-GR-NT 24" x 21-1/2" x 35"	Satin Nickel	22" or 24" wide See pages 284–286
White	VN2CHA-24-WH-NT 24" x 21-1/2" x 35"	Satin Nickel	22" or 24" wide See pages 284–286
Hale Blue	VN2CHA-24-BL-NT 24" x 21-1/2" x 35"	Satin Bronze	22" or 24" wide See pages 284–286
NEW Blue Steel	VN2CHA-24-BS-NT 24" x 21-1/2" x 35"	Matte Black	22" or 24" wide See pages 284–286

30" VANITY



VN2CHA-30-GN-NT

FINISH	VANITY	HARDWARE	MIRROR OPTIONS
Chocolate	VN2CHA-30-CH-NT 30" x 21-1/2" x 35"	Satin Nickel	24" or 28" wide See pages 284–286
Grey	VN2CHA-30-GR-NT 30" x 21-1/2" x 35"	Satin Nickel	24" or 28" wide See pages 284–286
White	VN2CHA-30-WH-NT 30" x 21-1/2" x 35"	Satin Nickel	24" or 28" wide See pages 284–286
Hale Blue	VN2CHA-30-BL-NT 30" x 21-1/2" x 35"	Satin Bronze	24" or 28" wide See pages 284–286
Forest Green	VN2CHA-30-GN-NT 30" x 21-1/2" x 35"	Satin Bronze	24" or 28" wide See pages 284–286
NEW Blue Steel	VN2CHA-30-BS-NT 30" x 21-1/2" x 35"	Matte Black	24" or 28" wide See pages 284–286

36" VANITY



VN2CHA-36-BL-NT

FINISH	VANITY	HARDWARE	MIRROR OPTIONS
Chocolate	VN2CHA-36-CH-NT 36" x 21-1/2" x 35"	Satin Nickel	33" or smaller See pages 284-286
Grey	VN2CHA-36-GR-NT 36" x 21-1/2" x 35"	Satin Nickel	33" or smaller See pages 284-286
White	VN2CHA-36-WH-NT 36" x 21-1/2" x 35"	Satin Nickel	33" or smaller See pages 284-286
Hale Blue	VN2CHA-36-BL-NT 36" x 21-1/2" x 35"	Satin Bronze	33" or smaller See pages 284-286
NEW Blue Steel	VN2CHA-36-BS-NT 36" x 21-1/2" x 35"	Matte Black	33" or smaller See pages 284-286

48" VANITY



VN2CHA-48-BS-NT

FINISH	VANITY	HARDWARE	MIRROR OPTIONS
Chocolate	VN2CHA-48-CH-NT 48" x 21-1/2" x 35"	Satin Nickel	33" or 40" wide See pages 284-286
Grey	VN2CHA-48-GR-NT 48" x 21-1/2" x 35"	Satin Nickel	33" or 40" wide See pages 284-286
White	VN2CHA-48-WH-NT 48" x 21-1/2" x 35"	Satin Nickel	33" or 40" wide See pages 284-286
Hale Blue	VN2CHA-48-BL-NT 48" x 21-1/2" x 35"	Satin Bronze	33" or 40" wide See pages 284-286
NEW Blue Steel	VN2CHA-30-BS-NT 48" x 21-1/2" x 35"	Matte Black	33" or 40" wide See pages 284-286

60" VANITY SINGLE BOWL



VN2CHA-60SCH-NT

FINISH	VANITY	HARDWARE	MIRROR OPTIONS
Chocolate	VN2CHA-60SCH-NT* 60" x 21-1/2" x 35"	Satin Nickel	30" or larger See pages 284-286
Grey	VN2CHA-60SGR-NT* 60" x 21-1/2" x 35"	Satin Nickel	30" or larger See pages 284-286
White	VN2CHA-60SWH-NT* 60" x 21-1/2" x 35"	Satin Nickel	30" or larger See pages 284-286

*The "S" in the item number designates this 60" vanity is designed for a single bowl.

60" VANITY DOUBLE BOWL



VN2CHA-60-GR-NT

FINISH	VANITY	HARDWARE	MIRROR OPTIONS
Chocolate	VN2CHA-60-CH-NT 60" x 21-1/2" x 35"	Satin Nickel	22" or 24" wide See pages 284-286
Grey	VN2CHA-60-GR-NT 60" x 21-1/2" x 35"	Satin Nickel	22" or 24" wide See pages 284-286
White	VN2CHA-60-WH-NT 60" x 21-1/2" x 35"	Satin Nickel	22" or 24" wide See pages 284-286

WHERE CAN I FIND THAT HARDWARE?



The decorative hardware included on this vanity are from the Bremen 1, Cordova, and Renzo (Blue Steel only) Collections. Find them in the Knobs & Pulls section of this catalog on pages 32 (Bremen 1), 43 (Cordova), and 90 (Renzo).



Dashwood Collection

Vanity: VN2DAS-48-NO-NT | Top: TOPR49CQ

Bowl: VN2-RECT-19 | Mirror: VMIR-METR-33MB

Featured wallpaper: Deconstructed Stripe by Schumacher

NEW

DASHWOOD

COLLECTION

Dashwood's mid-century modern design combines classic lines and understated luxury to provide an enduring fashionable appeal. This vanity collection by Jeffrey Alexander provides a touch of retro charm, while its practical design makes it perfect for modern living. For available mirrors, please see pages 284-286.



Ask about our
Vanity Display
Program!

PREMIUM FEATURES

- Premium undermount drawer slides feature soft-close and full-extension opening
- Hardwood drawers with strong & beautiful dovetail joinery
- Durable furniture-style wood construction
- Select from Jeffrey Alexander's top & bowl options to complete your design
- Lifetime warranty for original purchaser



FIND YOUR PEACE IN BLUE STEEL

From deep within the earth comes natural beauty and color. Between a tranquil bouquet of silver artemisia and a soothing natural blue celestite lies Jeffrey Alexander's Blue Steel finish.

See Blue Steel options in the following collections: Chatham, Dashwood, Gardner, Katara, Pascal, Tempest, and Theodora.

DASHWOOD COLLECTION

See pages 280–283 for available top & bowl options

AVAILABLE FINISHES



(WH)
White



(BS)
Blue Steel



NEW (DW)
Dark Walnut



NEW (NO)
Natural Oak

24" VANITY



VN2DAS-24-NO-NT

FINISH	VANITY	HARDWARE	MIRROR OPTIONS
White	VN2DAS-24-WH-NT 24" x 21-1/2" x 35"	Brushed Gold	22" or 24" wide See pages 284–286
NEW Dark Walnut	VN2DAS-24-DW-NT 24" x 21-1/2" x 35"	Brushed Gold	22" or 24" wide See pages 284–286
NEW Natural Oak	VN2DAS-24-NO-NT 24" x 21-1/2" x 35"	Matte Black	22" or 24" wide See pages 284–286

30" VANITY



VN2DAS-30-BS-NT

FINISH	VANITY	HARDWARE	MIRROR OPTIONS
White	VN2DAS-30-WH-NT 30" x 21-1/2" x 35"	Brushed Gold	24" or 28" wide See pages 284–286
Blue Steel	VN2DAS-30-BS-NT 30" x 21-1/2" x 35"	Brushed Gold	24" or 28" wide See pages 284–286
NEW Dark Walnut	VN2DAS-30-DW-NT 30" x 21-1/2" x 35"	Brushed Gold	24" or 28" wide See pages 284–286
NEW Natural Oak	VN2DAS-30-NO-NT 30" x 21-1/2" x 35"	Matte Black	24" or 28" wide See pages 284–286

36" VANITY



VN2DAS-36-DW-NT

FINISH	VANITY	HARDWARE	MIRROR OPTIONS
White	VN2DAS-36-WH-NT 36" x 21-1/2" x 35"	Brushed Gold	33" or smaller See pages 284–286
Blue Steel	VN2DAS-36-BS-NT 36" x 21-1/2" x 35"	Brushed Gold	33" or smaller See pages 284–286
NEW Dark Walnut	VN2DAS-36-DW-NT 36" x 21-1/2" x 35"	Brushed Gold	33" or smaller See pages 284–286
NEW Natural Oak	VN2DAS-36-NO-NT 36" x 21-1/2" x 35"	Matte Black	33" or smaller See pages 284–286

This vanity has a left offset bowl and requires a 37" top ending in CAD-ADD

42" VANITY



VN2DAS-42-WH-NT

FINISH	VANITY	HARDWARE	MIRROR OPTIONS
White	VN2DAS-42-WH-NT 42" x 21-1/2" x 35"	Brushed Gold	33" or 40" wide See pages 284-286
NEW Dark Walnut	VN2DAS-42-DW-NT 42" x 21-1/2" x 35"	Brushed Gold	33" or 40" wide See pages 284-286
NEW Natural Oak	VN2DAS-42-NO-NT 42" x 21-1/2" x 35"	Matte Black	33" or 40" wide See pages 284-286

This vanity has a left offset bowl and requires a 43" top ending in LFT

48" VANITY



VN2DAS-48-NO-NT

FINISH	VANITY	HARDWARE	MIRROR OPTIONS
White	VN2DAS-48-WH-NT 48" x 21-1/2" x 35"	Brushed Gold	33" or 40" wide See pages 284-286
Blue Steel	VN2DAS-48-BS-NT 48" x 21-1/2" x 35"	Brushed Gold	33" or 40" wide See pages 284-286
NEW Dark Walnut	VN2DAS-48-DW-NT 48" x 21-1/2" x 35"	Brushed Gold	33" or 40" wide See pages 284-286
NEW Natural Oak	VN2DAS-48-NO-NT 48" x 21-1/2" x 35"	Matte Black	33" or 40" wide See pages 284-286

60" VANITY DOUBLE BOWL



VN2DAS-60-DW-NT

FINISH	VANITY	HARDWARE	MIRROR OPTIONS
White	VN2DAS-60-WH-NT 60" x 21-1/2" x 35"	Brushed Gold	22" or 24" wide See pages 284-286
NEW Dark Walnut	VN2DAS-60-DW-NT 60" x 21-1/2" x 35"	Brushed Gold	22" or 24" wide See pages 284-286
NEW Natural Oak	VN2DAS-60-NO-NT 60" x 21-1/2" x 35"	Matte Black	22" or 24" wide See pages 284-286

WHERE CAN I FIND THAT HARDWARE?



The decorative hardware included on this vanity is from the Sutton Collection. Find it in the Knobs & Pulls section of this catalog on page 106.



Jubilee Collection

Vanity: VN2JUB-36-NO-NT | Top: TOPR37CQCAD-ADD

Bowl: VN2-RECT-19 | Mirror: VMIR-METC-30MB

Featured wallpaper: Solandra Vine by Schumacher

NEW

JUBILEE

COLLECTION

Jeffrey Alexander's Jubilee Vanity Collection is a celebration of tranquil minimalism. The uncomplicated design and purposeful storage generate a simple aesthetic. Gola-style hardware accents the dovetail drawers and hardwood tipouts, adding to Jubilee's understated elegance. Featuring an expansive open bottom shelf, Jubilee vanities provide a light, airy look without compromising functionality. For available mirrors, please see pages 284–286.



PREMIUM FEATURES

- Premium undermount drawer slides feature soft-close and full-extension opening
- Hardwood drawers with strong & beautiful dovetail joinery
- Hardwood tipout trays replace false-front drawers beneath the sink
- Durable furniture-style wood construction
- Select from Jeffrey Alexander's top & bowl options to complete your design
- Lifetime warranty for original purchaser



EMBRACE NATURE WITH NATURAL OAK

Natural Oak, with its warm, organic tones and subtle grain patterns, is an elegant vanity finish that effortlessly creates a sophisticated and inviting atmosphere in any bathroom space.

JUBILEE COLLECTION

See pages 280–283 for available top & bowl options

AVAILABLE FINISHES



(GR)
Grey



(WH)
White



(WG)
Weathered
Grey



NEW (DW)
Dark Walnut



NEW (NO)
Natural Oak

24" VANITY



VN2JUB-24-GR-NT

FINISH	VANITY	HARDWARE	MIRROR OPTIONS
Grey	VN2JUB-24-GR-NT 24" x 21-1/2" x 35"	Matte Black	22" or 24" wide See pages 284–286
White	VN2JUB-24-WH-NT 24" x 21-1/2" x 35"	Matte Black	22" or 24" wide See pages 284–286
Weathered Grey	VN2JUB-24-WG-NT 24" x 21-1/2" x 35"	Matte Black	22" or 24" wide See pages 284–286
NEW Dark Walnut	VN2JUB-24-DW-NT 24" x 21-1/2" x 35"	Satin Bronze	22" or 24" wide See pages 284–286
NEW Natural Oak	VN2JUB-24-NO-NT 24" x 21-1/2" x 35"	Matte Black	22" or 24" wide See pages 284–286

30" VANITY



VN2JUB-30-DW-NT

FINISH	VANITY	HARDWARE	MIRROR OPTIONS
Grey	VN2JUB-30-GR-NT 30" x 21-1/2" x 35"	Matte Black	24" or 28" wide See pages 284–286
White	VN2JUB-30-WH-NT 30" x 21-1/2" x 35"	Matte Black	24" or 28" wide See pages 284–286
Weathered Grey	VN2JUB-30-WG-NT 30" x 21-1/2" x 35"	Matte Black	24" or 28" wide See pages 284–286
NEW Dark Walnut	VN2JUB-30-DW-NT 30" x 21-1/2" x 35"	Satin Bronze	24" or 28" wide See pages 284–286
NEW Natural Oak	VN2JUB-30-NO-NT 30" x 21-1/2" x 35"	Matte Black	24" or 28" wide See pages 284–286

36" VANITY



VN2JUB-36-NO-NT

FINISH	VANITY	HARDWARE	MIRROR OPTIONS
Grey	VN2JUB-36-GR-NT 36" x 21-1/2" x 35"	Matte Black	33" or smaller See pages 284–286
White	VN2JUB-36-WH-NT 36" x 21-1/2" x 35"	Matte Black	33" or smaller See pages 284–286
Weathered Grey	VN2JUB-36-WG-NT 36" x 21-1/2" x 35"	Matte Black	33" or smaller See pages 284–286
NEW Dark Walnut	VN2JUB-36-DW-NT 36" x 21-1/2" x 35"	Satin Bronze	33" or smaller See pages 284–286
NEW Natural Oak	VN2JUB-36-NO-NT 36" x 21-1/2" x 35"	Matte Black	33" or smaller See pages 284–286

This vanity has a left offset bowl and requires a 37" top ending in CAD-ADD

42" VANITY



VN2JUB-42-WG-NT

FINISH	VANITY	HARDWARE	MIRROR OPTIONS
Grey	VN2JUB-42-GR-NT 42" x 21-1/2" x 35"	Matte Black	33" or 40" wide See pages 284-286
White	VN2JUB-42-WH-NT 42" x 21-1/2" x 35"	Matte Black	33" or 40" wide See pages 284-286
Weathered Grey	VN2JUB-42-WG-NT 42" x 21-1/2" x 35"	Matte Black	33" or 40" wide See pages 284-286
NEW Dark Walnut	VN2JUB-42-DW-NT 42" x 21-1/2" x 35"	Satin Bronze	33" or 40" wide See pages 284-286
NEW Natural Oak	VN2JUB-42-NO-NT 42" x 21-1/2" x 35"	Matte Black	33" or 40" wide See pages 284-286

This vanity has a left offset bowl and requires a 43" top ending in LFT

48" VANITY



VN2JUB-48-WH-NT

FINISH	VANITY	HARDWARE	MIRROR OPTIONS
Grey	VN2JUB-48-GR-NT 48" x 21-1/2" x 35"	Matte Black	33" or 40" wide See pages 284-286
White	VN2JUB-48-WH-NT 48" x 21-1/2" x 35"	Matte Black	33" or 40" wide See pages 284-286
Weathered Grey	VN2JUB-48-WG-NT 48" x 21-1/2" x 35"	Matte Black	33" or 40" wide See pages 284-286
NEW Dark Walnut	VN2JUB-48-DW-NT 48" x 21-1/2" x 35"	Satin Bronze	33" or 40" wide See pages 284-286
NEW Natural Oak	VN2JUB-48-NO-NT 48" x 21-1/2" x 35"	Matte Black	33" or 40" wide See pages 284-286

60" VANITY DOUBLE BOWL



VN2JUB-60-GR-NT

FINISH	VANITY	HARDWARE	MIRROR OPTIONS
Grey	VN2JUB-60-GR-NT 60" x 21-1/2" x 35"	Matte Black	22" or 24" wide See pages 284-286
White	VN2JUB-60-WH-NT 60" x 21-1/2" x 35"	Matte Black	22" or 24" wide See pages 284-286
Weathered Grey	VN2JUB-60-WG-NT 60" x 21-1/2" x 35"	Matte Black	22" or 24" wide See pages 284-286
NEW Dark Walnut	VN2JUB-60-DW-NT 60" x 21-1/2" x 35"	Satin Bronze	22" or 24" wide See pages 284-286
NEW Natural Oak	VN2JUB-60-NO-NT 60" x 21-1/2" x 35"	Matte Black	22" or 24" wide See pages 284-286



Katara Collection

Vanity: VN2KAT-60-BL-NT | Top: TOPR61CQ

Bowl: VN2-RECT-19 | Mirror: MIR2CAD-22-BL

KATARA

COLLECTION

In a world of chaos, the bathroom can be transformed into your utopian Zen space with a Jeffrey Alexander Katara vanity. The smooth calmness of the doors and drawer fronts is accentuated by a slight recession behind the pulls. Everything needed to create an oasis can be stored in the fully maximized storage spaces. For available mirrors, please see pages 284–286.



PREMIUM FEATURES

- Premium undermount drawer slides feature soft-close and full-extension opening
- Hardwood drawers with strong & beautiful dovetail joinery
- Hardwood tipout trays replace false-front drawers beneath the sink
- Durable furniture-style wood construction
- Select from Jeffrey Alexander's top & bowl options to complete your design
- Lifetime warranty for original purchaser



KATARA COLLECTION

See pages 280–283 for available top & bowl options

AVAILABLE FINISHES



(WH)
White



(GR)
Grey



(BK)
Black



(BL)
Hale Blue



(GN)
Forest Green



(BS)
Blue Steel

24" VANITY



VN2KAT-24-BK-NT

FINISH	VANITY	HARDWARE	MIRROR OPTIONS
Black	VN2KAT-24-BK-NT 24" x 21-1/2" x 35"	Polished Chrome	22" or 24" wide See pages 284–286
Grey	VN2KAT-24-GR-NT 24" x 21-1/2" x 35"	Matte Black	22" or 24" wide See pages 284–286
White	VN2KAT-24-WH-NT 24" x 21-1/2" x 35"	Matte Black	22" or 24" wide See pages 284–286
Hale Blue	VN2KAT-24-BL-NT 24" x 21-1/2" x 35"	Satin Bronze	22" or 24" wide See pages 284–286

30" VANITY



VN2KAT-30-BL-NT

FINISH	VANITY	HARDWARE	MIRROR OPTIONS
Black	VN2KAT-30-BK-NT 30" x 21-1/2" x 35"	Polished Chrome	24" or 28" wide See pages 284–286
Grey	VN2KAT-30-GR-NT 30" x 21-1/2" x 35"	Matte Black	24" or 28" wide See pages 284–286
White	VN2KAT-30-WH-NT 30" x 21-1/2" x 35"	Matte Black	24" or 28" wide See pages 284–286
Hale Blue	VN2KAT-30-BL-NT 30" x 21-1/2" x 35"	Satin Bronze	24" or 28" wide See pages 284–286
Forest Green	VN2KAT-30-GN-NT 30" x 21-1/2" x 35"	Satin Bronze	24" or 28" wide See pages 284–286
Blue Steel	VN2KAT-30-BS-NT 30" x 21-1/2" x 35"	Brushed Gold	24" or 28" wide See pages 284–286

36" VANITY



VN2KAT-36-BS-NT

FINISH	VANITY	HARDWARE	MIRROR OPTIONS
Black	VN2KAT-36-BK-NT 36" x 21-1/2" x 35"	Polished Chrome	33" or smaller See pages 284–286
Grey	VN2KAT-36-GR-NT 36" x 21-1/2" x 35"	Matte Black	33" or smaller See pages 284–286
White	VN2KAT-36-WH-NT 36" x 21-1/2" x 35"	Matte Black	33" or smaller See pages 284–286
Hale Blue	VN2KAT-36-BL-NT 36" x 21-1/2" x 35"	Satin Bronze	33" or smaller See pages 284–286
Forest Green	VN2KAT-36-GN-NT 36" x 21-1/2" x 35"	Satin Bronze	33" or smaller See pages 284–286
Blue Steel	VN2KAT-36-BS-NT 36" x 21-1/2" x 35"	Brushed Gold	33" or smaller See pages 284–286

This vanity has a left offset bowl and requires a 37" top ending in CAD-ADD

42" VANITY



VN2KAT-42-GN-NT

FINISH	VANITY	HARDWARE	MIRROR OPTIONS
Black	VN2KAT-42-BK-NT 42" x 21-1/2" x 35"	Polished Chrome	33" or 40" wide See pages 284-286
Grey	VN2KAT-42-GR-NT 42" x 21-1/2" x 35"	Matte Black	33" or 40" wide See pages 284-286
White	VN2KAT-42-WH-NT 42" x 21-1/2" x 35"	Matte Black	33" or 40" wide See pages 284-286
Hale Blue	VN2KAT-42-BL-NT 42" x 21-1/2" x 35"	Satin Bronze	33" or 40" wide See pages 284-286
Forest Green	VN2KAT-42-GN-NT 42" x 21-1/2" x 35"	Satin Bronze	33" or 40" wide See pages 284-286
Blue Steel	VN2KAT-42-BS-NT 42" x 21-1/2" x 35"	Brushed Gold	33" or 40" wide See pages 284-286

This vanity has a left offset bowl and requires a 43" top ending in LFT

48" VANITY



VN2KAT-48-WH-NT

FINISH	VANITY	HARDWARE	MIRROR OPTIONS
Black	VN2KAT-48-BK-NT 48" x 21-1/2" x 35"	Polished Chrome	33" or 40" wide See pages 284-286
Grey	VN2KAT-48-GR-NT 48" x 21-1/2" x 35"	Matte Black	33" or 40" wide See pages 284-286
White	VN2KAT-48-WH-NT 48" x 21-1/2" x 35"	Matte Black	33" or 40" wide See pages 284-286
Hale Blue	VN2KAT-48-BL-NT 48" x 21-1/2" x 35"	Satin Bronze	33" or 40" wide See pages 284-286
Forest Green	VN2KAT-48-GN-NT 48" x 21-1/2" x 35"	Satin Bronze	33" or 40" wide See pages 284-286
Blue Steel	VN2KAT-48-BS-NT 48" x 21-1/2" x 35"	Brushed Gold	33" or 40" wide See pages 284-286

60" VANITY DOUBLE BOWL



VN2KAT-60-GR-NT

FINISH	VANITY	HARDWARE	MIRROR OPTIONS
Black	VN2KAT-60-BK-NT 60" x 21-1/2" x 35"	Polished Chrome	22" or 24" wide See pages 284-286
Grey	VN2KAT-60-GR-NT 60" x 21-1/2" x 35"	Matte Black	22" or 24" wide See pages 284-286
White	VN2KAT-60-WH-NT 60" x 21-1/2" x 35"	Matte Black	22" or 24" wide See pages 284-286
Hale Blue	VN2KAT-60-BL-NT 60" x 21-1/2" x 35"	Satin Bronze	22" or 24" wide See pages 284-286

WHERE CAN I FIND THAT HARDWARE?



The decorative hardware included on this vanity is from the Dominique Collection. Find it in the Knobs & Pulls section of this catalog on page 46.

NEW KIPLING COLLECTION

COMING EARLY 2024



Kipling Collection
Vanity: VN2KIP-36-BK-NT | Top: TOPR37CQ
Bowl: VN2-RECT-19 | Mirror: MIR2CAD-24-BK

AVAILABLE FINISHES



(WH)
White



(BK)
Black

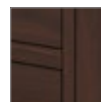

NEW (DW)
Dark Walnut

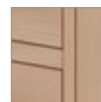

NEW (NO)
Natural Oak

See pages 280–283 for available top & bowl options

Discover the Kipling Vanity Collection by Jeffrey Alexander—a Shaker-style classic exquisitely reimagined. This collection seamlessly blends timeless Shaker aesthetics with modern functionality. Hardwood craftsmanship, square legs, and an open bottom shelf gracefully unite style and practicality. Dovetail drawers and hardwood tipout trays provide functional storage while being adorned by Jeffrey Alexander’s Richard pulls to emphasize both quality and elegance. For available mirrors, please see pages 284–286.

PREMIUM FEATURES

- Premium undermount drawer slides feature soft-close and full-extension opening
- Hardwood drawers with strong & beautiful dovetail joinery
- Hardwood tipout trays replace false-front drawers beneath the sink
- Durable furniture-style wood construction
- Select from Jeffrey Alexander’s top & bowl options to complete your design
- Lifetime warranty for original purchaser



WHERE CAN I FIND THAT HARDWARE?



The decorative hardware included on this vanity are from the Richard Collection. Find it in the Knobs & Pulls section of this catalog on page 94.

30" VANITY



VN2KIP-30-BK-NT

FINISH	VANITY	HARDWARE	MIRROR OPTIONS
White	VN2KIP-30-WH-NT 30" x 21-1/2" x 35"	Brushed Gold	24" or 28" wide See pages 284-286
Black	VN2KIP-30-BK-NT 30" x 21-1/2" x 35"	Satin Bronze	24" or 28" wide See pages 284-286
NEW Dark Walnut	VN2KIP-30-DW-NT 30" x 21-1/2" x 35"	Brushed Gold	24" or 28" wide See pages 284-286
NEW Natural Oak	VN2KIP-30-NO-NT 30" x 21-1/2" x 35"	Matte Black	24" or 28" wide See pages 284-286

36" VANITY



VN2KIP-36-DW-NT

FINISH	VANITY	HARDWARE	MIRROR OPTIONS
White	VN2KIP-36-WH-NT 36" x 21-1/2" x 35"	Brushed Gold	33" or smaller See pages 284-286
Black	VN2KIP-36-BK-NT 36" x 21-1/2" x 35"	Satin Bronze	33" or smaller See pages 284-286
NEW Dark Walnut	VN2KIP-36-DW-NT 36" x 21-1/2" x 35"	Brushed Gold	33" or smaller See pages 284-286
NEW Natural Oak	VN2KIP-36-NO-NT 36" x 21-1/2" x 35"	Matte Black	33" or smaller See pages 284-286

48" VANITY



VN2KIP-48-NO-NT

FINISH	VANITY	HARDWARE	MIRROR OPTIONS
White	VN2KIP-48-WH-NT 48" x 21-1/2" x 35"	Brushed Gold	33" or 40" wide See pages 284-286
Black	VN2KIP-48-BK-NT 48" x 21-1/2" x 35"	Satin Bronze	33" or 40" wide See pages 284-286
NEW Dark Walnut	VN2KIP-48-DW-NT 48" x 21-1/2" x 35"	Brushed Gold	33" or 40" wide See pages 284-286
NEW Natural Oak	VN2KIP-48-NO-NT 48" x 21-1/2" x 35"	Matte Black	33" or 40" wide See pages 284-286

60" VANITY DOUBLE BOWL



VN2KIP-60-WH-NT

FINISH	VANITY	HARDWARE	MIRROR OPTIONS
White	VN2KIP-60-WH-NT 60" x 21-1/2" x 35"	Brushed Gold	22" or 24" wide See pages 284-286
Black	VN2KIP-60-BK-NT 60" x 21-1/2" x 35"	Satin Bronze	22" or 24" wide See pages 284-286
NEW Dark Walnut	VN2KIP-60-DW-NT 60" x 21-1/2" x 35"	Brushed Gold	22" or 24" wide See pages 284-286
NEW Natural Oak	VN2KIP-60-NO-NT 60" x 21-1/2" x 35"	Matte Black	22" or 24" wide See pages 284-286



Pascal Collection

Vanity: VN2PAS-48-DW-NT | Top: TOPR49CQ

Bowl: VN2-RECT-19 | Mirror: VMIR-METC-30BG

Featured wallpaper: *Queen of Spain* from Schumacher

NEW

PASCAL

COLLECTION

The Pascal Vanity Collection by Jeffrey Alexander combines elements of nature with a touch of heavy metal to create an elegant yet substantial collection. Pascal features exteriors of natural wood and a metal frame that gives the vanity a subtle vibe of industrial edginess. The unique design includes ample storage behind soft-close doors and drawers as well as an open lower shelf. For available mirrors, please see pages 284–286.



PREMIUM FEATURES

- Premium undermount drawer slides feature soft-close and full-extension opening
- Durable furniture-style wood construction
- Hardwood drawers with strong & beautiful dovetail joinery
- Select from Jeffrey Alexander's top & bowl options to complete your design
- Lifetime warranty for original purchaser



PASCAL COLLECTION

See pages 280–283 for available top & bowl options

24" VANITY



VN2PAS-24-DW-NT

30" VANITY



VN2PAS-30-BS-NT

36" VANITY



VN2PAS-36-GR-NT

AVAILABLE FINISHES



(GR)
Grey



(WH)
White



(BS)
Blue Steel



(WG)
Weathered
Grey



NEW (DW)
Dark Walnut



NEW (NO)
Natural Oak

FINISH	VANITY	HARDWARE	MIRROR OPTIONS
Grey	VN2PAS-24-GR-NT 24" x 21-1/2" x 35"	Matte Black	22" or 24" wide See pages 284–286
White	VN2PAS-24-WH-NT 24" x 21-1/2" x 35"	Matte Black	22" or 24" wide See pages 284–286
Blue Steel	VN2PAS-24-BS-NT 24" x 21-1/2" x 35"	Matte Black	22" or 24" wide See pages 284–286
Weathered Grey	VN2PAS-24-WG-NT 24" x 21-1/2" x 35"	Matte Black	22" or 24" wide See pages 284–286
NEW Dark Walnut	VN2PAS-24-DW-NT 24" x 21-1/2" x 35"	Matte Black and Brushed Gold	22" or 24" wide See pages 284–286
NEW Natural Oak	VN2PAS-24-NO-NT 24" x 21-1/2" x 35"	Matte Black	22" or 24" wide See pages 284–286

FINISH	VANITY	HARDWARE	MIRROR OPTIONS
Grey	VN2PAS-30-GR-NT 30" x 21-1/2" x 35"	Matte Black	24" or 28" wide See pages 284–286
White	VN2PAS-30-WH-NT 30" x 21-1/2" x 35"	Matte Black	24" or 28" wide See pages 284–286
Blue Steel	VN2PAS-30-BS-NT 30" x 21-1/2" x 35"	Matte Black	24" or 28" wide See pages 284–286
Weathered Grey	VN2PAS-30-WG-NT 30" x 21-1/2" x 35"	Matte Black	24" or 28" wide See pages 284–286
NEW Dark Walnut	VN2PAS-30-DW-NT 30" x 21-1/2" x 35"	Matte Black and Brushed Gold	24" or 28" wide See pages 284–286
NEW Natural Oak	VN2PAS-30-NO-NT 30" x 21-1/2" x 35"	Matte Black	24" or 28" wide See pages 284–286

FINISH	VANITY	HARDWARE	MIRROR OPTIONS
Grey	VN2PAS-36-GR-NT 36" x 21-1/2" x 35"	Matte Black	33" or smaller See pages 284–286
White	VN2PAS-36-WH-NT 36" x 21-1/2" x 35"	Matte Black	33" or smaller See pages 284–286
Blue Steel	VN2PAS-36-BS-NT 36" x 21-1/2" x 35"	Matte Black	33" or smaller See pages 284–286
Weathered Grey	VN2PAS-36-WG-NT 36" x 21-1/2" x 35"	Matte Black	33" or smaller See pages 284–286
NEW Dark Walnut	VN2PAS-36-DW-NT 36" x 21-1/2" x 35"	Matte Black and Brushed Gold	33" or smaller See pages 284–286
NEW Natural Oak	VN2PAS-36-NO-NT 36" x 21-1/2" x 35"	Matte Black	33" or smaller See pages 284–286

This vanity has a left offset bowl and requires a 37" top ending in CAD-ADD

42" VANITY



VN2PAS-42-WH-NT

FINISH	VANITY	HARDWARE	MIRROR OPTIONS
Grey	VN2PAS-42-GR-NT 42" x 21-1/2" x 35"	Matte Black	33" or 40" wide See pages 284-286
White	VN2PAS-42-WH-NT 42" x 21-1/2" x 35"	Matte Black	33" or 40" wide See pages 284-286
NEW Dark Walnut	VN2PAS-42-DW-NT 42" x 21-1/2" x 35"	Matte Black and Brushed Gold	33" or 40" wide See pages 284-286
NEW Natural Oak	VN2PAS-42-NO-NT 42" x 21-1/2" x 35"	Matte Black	33" or 40" wide See pages 284-286

This vanity has a left offset bowl and requires a 43" top ending in LFT

48" VANITY



VN2PAS-48-WG-NT

FINISH	VANITY	HARDWARE	MIRROR OPTIONS
Grey	VN2PAS-48-GR-NT 48" x 21-1/2" x 35"	Matte Black	33" or 40" wide See pages 284-286
White	VN2PAS-48-WH-NT 48" x 21-1/2" x 35"	Matte Black	33" or 40" wide See pages 284-286
Blue Steel	VN2PAS-48-BS-NT 48" x 21-1/2" x 35"	Matte Black	33" or 40" wide See pages 284-286
Weathered Grey	VN2PAS-48-WG-NT 48" x 21-1/2" x 35"	Matte Black	33" or 40" wide See pages 284-286
NEW Dark Walnut	VN2PAS-48-DW-NT 48" x 21-1/2" x 35"	Matte Black and Brushed Gold	33" or 40" wide See pages 284-286
NEW Natural Oak	VN2PAS-48-NO-NT 48" x 21-1/2" x 35"	Matte Black	33" or 40" wide See pages 284-286

60" VANITY DOUBLE BOWL



VN2PAS-60-NO-NT

FINISH	VANITY	HARDWARE	MIRROR OPTIONS
Grey	VN2PAS-60-GR-NT 60" x 21-1/2" x 35"	Matte Black	22" or 24" wide See pages 284-286
White	VN2PAS-60-WH-NT 60" x 21-1/2" x 35"	Matte Black	22" or 24" wide See pages 284-286
Weathered Grey	VN2PAS-60-WG-NT 60" x 21-1/2" x 35"	Matte Black	22" or 24" wide See pages 284-286
NEW Dark Walnut	VN2PAS-60-DW-NT 60" x 21-1/2" x 35"	Matte Black and Brushed Gold	22" or 24" wide See pages 284-286
NEW Natural Oak	VN2PAS-60-NO-NT 60" x 21-1/2" x 35"	Matte Black	22" or 24" wide See pages 284-286

WHERE CAN I FIND THAT HARDWARE?



The decorative hardware included on this vanity is from the Larkin Collection. Find it in the Knobs & Pulls section of this catalog on page 68.

PERCIVAL COLLECTION

AVAILABLE FINISHES



(WH)
White

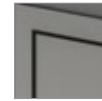

(GR)
Grey



(BK)
Black



(BL)
Hale Blue

See pages 280–283 for available top & bowl options

The Percival Vanity Collection by Jeffrey Alexander simply enriches a room with dignified grace. Refined elegance is accentuated through Percival's quiet and peaceful nature. The doors are adorned with a subtle metal accent trim to perfectly complement the vanity's finish. This stylish trim is all the ornamentation needed to generate a resplendent presence in a room designed with class. For available mirrors, please see pages 284–286.



Percival Collection

Vanity: VN2PER-36-WH-NT | Top: TOPR37ASCAD-ADD
Bowl: VN2-RECT-19 | Mirror: MIR2CAD-33-WH

PREMIUM FEATURES

- Stylish metal accent trim on each vanity door
- Premium undermount drawer slides feature soft-close and full-extension opening
- Hardwood drawers with strong & beautiful dovetail joinery
- Durable furniture-style wood construction
- Select from Jeffrey Alexander's top & bowl options to complete your design
- Lifetime warranty for original purchaser



24" VANITY



VN2PER-24-BL-NT

FINISH	VANITY	METAL TRIM	MIRROR OPTIONS
Black	VN2PER-24-BK-NT 24" x 21-1/2" x 35"	Chrome	22" or 24" wide See pages 284-286
Grey	VN2PER-24-GR-NT 24" x 21-1/2" x 35"	Matte Black	22" or 24" wide See pages 284-286
White	VN2PER-24-WH-NT 24" x 21-1/2" x 35"	Bronze	22" or 24" wide See pages 284-286
Hale Blue	VN2PER-24-BL-NT 24" x 21-1/2" x 35"	Bronze	22" or 24" wide See pages 284-286

30" VANITY



VN2PER-30-GR-NT

FINISH	VANITY	METAL TRIM	MIRROR OPTIONS
Black	VN2PER-30-BK-NT 24" x 21-1/2" x 35"	Chrome	24" or 28" wide See pages 284-286
Grey	VN2PER-30-GR-NT 24" x 21-1/2" x 35"	Matte Black	24" or 28" wide See pages 284-286
White	VN2PER-30-WH-NT 24" x 21-1/2" x 35"	Bronze	24" or 28" wide See pages 284-286
Hale Blue	VN2PER-30-BL-NT 24" x 21-1/2" x 35"	Bronze	24" or 28" wide See pages 284-286

36" VANITY



VN2PER-36-BK-NT

FINISH	VANITY	METAL TRIM	MIRROR OPTIONS
Black	VN2PER-36-BK-NT 24" x 21-1/2" x 35"	Chrome	33" or smaller See pages 284-286
Grey	VN2PER-36-GR-NT 24" x 21-1/2" x 35"	Matte Black	33" or smaller See pages 284-286
White	VN2PER-36-WH-NT 24" x 21-1/2" x 35"	Bronze	33" or smaller See pages 284-286
Hale Blue	VN2PER-36-BL-NT 24" x 21-1/2" x 35"	Bronze	33" or smaller See pages 284-286

This vanity has a left offset bowl and requires a 37" top ending in CAD-ADD

**Bath
Vanities**



Theodora Collection

Vanity: VN2THE-36-GN-NT | Top: TOPR37RE-LFT

Bowl: Integrated | Mirror: MIR2CAD-33-GN

THEODORA

COLLECTION

Jeffrey Alexander's Theodora vanity collection possesses an aesthetic cleanse through slab doors, simple lines, and minimal footprint tab pulls. The timeless mid-century elements that Theodora illustrates merge gracefully with the modern style of today's homes. Remaining true to the style, these vanities are largely un-ornamented on the exterior, yet boast an exorbitant amount of functionality within. For available mirrors, please see pages 284–286.



Theodora Collection

Vanity: VN2THE-60-GR-NT | Top: TOPR61CQ
Bowl: VN2-RECT-19 | Mirror: MIR2CAD-22-GR

PREMIUM FEATURES

- Premium undermount drawer slides feature soft-close and full-extension opening
- Hardwood drawers with strong & beautiful dovetail joinery
- Durable furniture-style wood construction
- Select from Jeffrey Alexander's top & bowl options to complete your design
- Lifetime warranty for original purchaser



THEODORA COLLECTION

See pages 280–283 for available top & bowl options

AVAILABLE FINISHES



(WH)
White



(GR)
Grey



(BK)
Black



(BL)
Hale Blue



(GN)
Forest Green



(BS)
Blue Steel

24" VANITY



VN2THE-24-BS-NT

FINISH	VANITY	HARDWARE	MIRROR
Black	VN2THE-24-BK-NT 24" x 21-1/2" x 35"	Polished Chrome	22" or 24" wide See pages 284–286
Grey	VN2THE-24-GR-NT 24" x 21-1/2" x 35"	Polished Chrome	22" or 24" wide See pages 284–286
White	VN2THE-24-WH-NT 24" x 21-1/2" x 35"	Polished Chrome	22" or 24" wide See pages 284–286
Hale Blue	VN2THE-24-BL-NT 24" x 21-1/2" x 35"	Satin Bronze	22" or 24" wide See pages 284–286
Blue Steel	VN2THE-24-BS-NT 24" x 21-1/2" x 35"	Polished Chrome	22" or 24" wide See pages 284–286

30" VANITY



VN2THE-30-BK-NT

FINISH	VANITY	HARDWARE	MIRROR
Black	VN2THE-30-BK-NT 30" x 21-1/2" x 35"	Polished Chrome	24" or 28" wide See pages 284–286
Grey	VN2THE-30-GR-NT 30" x 21-1/2" x 35"	Polished Chrome	24" or 28" wide See pages 284–286
White	VN2THE-30-WH-NT 30" x 21-1/2" x 35"	Polished Chrome	24" or 28" wide See pages 284–286
Hale Blue	VN2THE-30-BL-NT 30" x 21-1/2" x 35"	Satin Bronze	24" or 28" wide See pages 284–286
Forest Green	VN2THE-30-GN-NT 30" x 21-1/2" x 35"	Satin Bronze	24" or 28" wide See pages 284–286
Blue Steel	VN2THE-30-BS-NT 30" x 21-1/2" x 35"	Polished Chrome	24" or 28" wide See pages 284–286

36" VANITY



VN2THE-36-GN-NT

FINISH	VANITY	HARDWARE	MIRROR
Black	VN2THE-36-BK-NT 36" x 21-1/2" x 35"	Polished Chrome	33" or smaller See pages 284–286
Grey	VN2THE-36-GR-NT 36" x 21-1/2" x 35"	Polished Chrome	33" or smaller See pages 284–286
White	VN2THE-36-WH-NT 36" x 21-1/2" x 35"	Polished Chrome	33" or smaller See pages 284–286
Hale Blue	VN2THE-36-BL-NT 36" x 21-1/2" x 35"	Satin Bronze	33" or smaller See pages 284–286
Forest Green	VN2THE-36-GN-NT 36" x 21-1/2" x 35"	Satin Bronze	33" or smaller See pages 284–286
Blue Steel	VN2THE-36-BS-NT 36" x 21-1/2" x 35"	Polished Chrome	33" or smaller See pages 284–286

This vanity has a left offset bowl and requires a 37" top ending in CAD-ADD

48" VANITY



VN2THE-48-GR-NT

FINISH	VANITY	HARDWARE	MIRROR
Black	VN2THE-48-BK-NT 48" x 21-1/2" x 35"	Polished Chrome	33" or 40" wide See pages 284-286
Grey	VN2THE-48-GR-NT 48" x 21-1/2" x 35"	Polished Chrome	33" or 40" wide See pages 284-286
White	VN2THE-48-WH-NT 48" x 21-1/2" x 35"	Polished Chrome	33" or 40" wide See pages 284-286
Hale Blue	VN2THE-48-BL-NT 48" x 21-1/2" x 35"	Satin Bronze	33" or 40" wide See pages 284-286
Forest Green	VN2THE-48-GN-NT 48" x 21-1/2" x 35"	Satin Bronze	33" or 40" wide See pages 284-286
Blue Steel	VN2THE-48-BS-NT 48" x 21-1/2" x 35"	Polished Chrome	33" or 40" wide See pages 284-286

60" VANITY DOUBLE BOWL



VN2THE-60-BL-NT

FINISH	VANITY	HARDWARE	MIRROR
Black	VN2THE-60-BK-NT 60" x 21-1/2" x 35"	Polished Chrome	22" or 24" wide See pages 284-286
Grey	VN2THE-60-GR-NT 60" x 21-1/2" x 35"	Polished Chrome	22" or 24" wide See pages 284-286
White	VN2THE-60-WH-NT 60" x 21-1/2" x 35"	Polished Chrome	22" or 24" wide See pages 284-286
Hale Blue	VN2THE-60-BL-NT 60" x 21-1/2" x 35"	Satin Bronze	22" or 24" wide See pages 284-286
Blue Steel	VN2THE-60-BS-NT 60" x 21-1/2" x 35"	Polished Chrome	22" or 24" wide See pages 284-286



Theodora Collection
Vanity: VN2THE-24-BS-NT | Top: TOPR25WC
Bowl: VN2-RECT-16 | Mirror: MIR2CAD-22-BS



Wavecrest Collection
Vanity: VN2WAV-48-GR-NT | Top: TOPR49WC
Bowl: VN2-RECT-19 | Mirror: MIR2CAD-33-GR

WAVECREST COLLECTION

Escape to the seaside with the Wavecrest vanity collection. Crisp, clean edges and a slatted bottom shelf evoke a feeling of stepping out into the calm of the seaside. False-front drawers with breezy Key West pulls are transformed into hidden tipout storage space with solid wood trays. For available mirrors, please see pages 284–286.



Wavecrest Collection
Vanity: VN2WAV-60-WH-NT | Top: Custom
Bowl: VN2-RECT-19 | Mirror: MIR2CAD-22-WH

PREMIUM FEATURES

- Premium undermount drawer slides feature soft-close and full-extension opening
- Hardwood drawers with strong & beautiful dovetail joinery
- Hardwood tipout trays replace false-front drawers beneath the sink
- Durable furniture-style wood construction
- Select from Jeffrey Alexander's top & bowl options to complete your design
- Lifetime warranty for original purchaser



WAVECREST COLLECTION

See pages 280–283 for available top & bowl options

AVAILABLE FINISHES



(WH)
White



(GR)
Grey



(BL)
Hale Blue



(GN)
Forest Green



(WG)
Weathered
Grey

24" VANITY



VN2WAV-24-GR-NT

FINISH	VANITY	HARDWARE	MIRROR OPTIONS
Grey	VN2WAV-24-GR-NT 24" x 21-1/2" x 35"	Satin Nickel	22" or 24" wide See pages 284–286
White	VN2WAV-24-WH-NT 24" x 21-1/2" x 35"	Matte Black	22" or 24" wide See pages 284–286
Weathered Grey	VN2WAV-24-WG-NT 24" x 21-1/2" x 35"	Matte Black	22" or 24" wide See pages 284–286

30" VANITY



VN2WAV-30-BL-NT

FINISH	VANITY	HARDWARE	MIRROR OPTIONS
Grey	VN2WAV-30-GR-NT 30" x 21-1/2" x 35"	Satin Nickel	24" or 28" wide See pages 284–286
White	VN2WAV-30-WH-NT 30" x 21-1/2" x 35"	Matte Black	24" or 28" wide See pages 284–286
Hale Blue	VN2WAV-30-BL-NT 30" x 21-1/2" x 35"	Satin Bronze	24" or 28" wide See pages 284–286
Forest Green	VN2WAV-30-GN-NT 30" x 21-1/2" x 35"	Satin Bronze	24" or 28" wide See pages 284–286
Weathered Grey	VN2WAV-30-WG-NT 30" x 21-1/2" x 35"	Matte Black	24" or 28" wide See pages 284–286

36" VANITY



VN2WAV-36-GN-NT

FINISH	VANITY	HARDWARE	MIRROR OPTIONS
Grey	VN2WAV-36-GR-NT 36" x 21-1/2" x 35"	Satin Nickel	33" or smaller See pages 284–286
White	VN2WAV-36-WH-NT 36" x 21-1/2" x 35"	Matte Black	33" or smaller See pages 284–286
Hale Blue	VN2WAV-36-BL-NT 36" x 21-1/2" x 35"	Satin Bronze	33" or smaller See pages 284–286
Forest Green	VN2WAV-36-GN-NT 36" x 21-1/2" x 35"	Satin Bronze	33" or smaller See pages 284–286
Weathered Grey	VN2WAV-36-WG-NT 36" x 21-1/2" x 35"	Matte Black	33" or smaller See pages 284–286

48" VANITY



VN2WAV-48-WG-NT

FINISH	VANITY	HARDWARE	MIRROR OPTIONS
Grey	VN2WAV-48-GR-NT 48" x 21-1/2" x 35"	Satin Nickel	33" or 40" wide See pages 284-286
White	VN2WAV-48-WH-NT 48" x 21-1/2" x 35"	Matte Black	33" or 40" wide See pages 284-286
Hale Blue	VN2WAV-48-BL-NT 48" x 21-1/2" x 35"	Satin Bronze	33" or 40" wide See pages 284-286
Forest Green	VN2WAV-48-GN-NT 48" x 21-1/2" x 35"	Satin Bronze	33" or 40" wide See pages 284-286
Weathered Grey	VN2WAV-48-WG-NT 48" x 21-1/2" x 35"	Matte Black	33" or 40" wide See pages 284-286

60" VANITY DOUBLE BOWL



VN2WAV-60-GR-NT

FINISH	VANITY	HARDWARE	MIRROR OPTIONS
Grey	VN2WAV-60-GR-NT 60" x 21-1/2" x 35"	Satin Nickel	22" or 24" wide See pages 284-286
White	VN2WAV-60-WH-NT 60" x 21-1/2" x 35"	Matte Black	22" or 24" wide See pages 284-286
Weathered Grey	VN2WAV-60-WG-NT 60" x 21-1/2" x 35"	Matte Black	22" or 24" wide See pages 284-286

WHERE CAN I FIND THAT HARDWARE?



The decorative hardware included on this vanity is from the Key West Collection. Find it in the Knobs & Pulls section of this catalog on page 64.



Wavecrest Collection

Vanity: VN2WAV-60-WG-NT | Top: TOPR61LS

Bowl: VN2-RECT-19 | Mirror: MIR2CAD-22-WG

ASTORIA COLLECTION

AVAILABLE FINISHES



(WH)
White



(GR)
Grey



(ES)
Espresso

See pages 280–283 for
available top & bowl options

RETIRED

This hardwood vanity features clean lines with a stepped door profile for a modern look. The deep Espresso, soft White, or modern Grey finish with Slade knobs in Satin Nickel complements the style. For available mirrors, please see pages 284–286.



Astoria Collection

Vanity: VN2AST-48-WH-NT | Top: TOPR49LS
Bowl: VN2-RECT-19 | Mirror: MIR2AST-28-WH

PREMIUM FEATURES

- Premium undermount drawer slides feature soft-close and full-extension opening
- Hardwood drawers with strong & beautiful dovetail joinery
- Hardwood tipout trays replace false-front drawers beneath the sink
- Durable furniture-style wood construction
- Select from Jeffrey Alexander's top & bowl options to complete your design
- Lifetime warranty for original purchaser



24" VANITY



VN2AST-24-ES-NT

FINISH	VANITY	HARDWARE	MIRROR OPTIONS
Espresso	VN2AST-24-ES-NT 24" x 21-1/2" x 35"	Satin Nickel	22" or 24" wide See pages 284–286
Grey	VN2AST-24-GR-NT 24" x 21-1/2" x 35"	Satin Nickel	22" or 24" wide See pages 284–286
White	VN2AST-24-WH-NT 24" x 21-1/2" x 35"	Satin Nickel	22" or 24" wide See pages 284–286

30" VANITY



VN2AST-30-GR-NT

FINISH	VANITY	HARDWARE	MIRROR OPTIONS
Espresso	VN2AST-30-ES-NT 30" x 21-1/2" x 35"	Satin Nickel	24" or 28" wide See pages 284–286
Grey	VN2AST-30-GR-NT 30" x 21-1/2" x 35"	Satin Nickel	24" or 28" wide See pages 284–286
White	VN2AST-30-WH-NT 30" x 21-1/2" x 35"	Satin Nickel	24" or 28" wide See pages 284–286

36" VANITY



VN2AST-36-WH-NT

FINISH	VANITY	HARDWARE	MIRROR OPTIONS
Espresso	VN2AST-36-ES-NT 36" x 21-1/2" x 35"	Satin Nickel	33" wide or smaller See pages 284–286
Grey	VN2AST-36-GR-NT 36" x 21-1/2" x 35"	Satin Nickel	33" wide or smaller See pages 284–286
White	VN2AST-36-WH-NT 36" x 21-1/2" x 35"	Satin Nickel	33" wide or smaller See pages 284–286

This vanity has a right offset bowl and requires a 37" top ending in AST

48" VANITY



VN2AST-48-GR-NT

FINISH	VANITY	HARDWARE	MIRROR OPTIONS
Espresso	VN2AST-48-ES-NT 48" x 21-1/2" x 35"	Satin Nickel	33", 40" or 42" wide See pages 284–286
Grey	VN2AST-48-GR-NT 48" x 21-1/2" x 35"	Satin Nickel	33", 40" or 42" wide See pages 284–286
White	VN2AST-48-WH-NT 48" x 21-1/2" x 35"	Satin Nickel	33", 40" or 42" wide See pages 284–286

WHERE CAN I FIND THAT HARDWARE?



The decorative hardware included on this vanity is from the Slade Collection. Find it in the Knobs & Pulls section of this catalog on page 164.

SAVINO COLLECTION

AVAILABLE FINISHES



(WH)
White



(GR)
Grey

See pages 280–283 for
available top & bowl options

RETIRED



Savino Collection

Vanity: VN2SAV-24-WH-NT | Top: TOPO25LS
Bowl: VN2-OVAL-15 | Mirror: MIR2CHA-22-WH

Savino provides a fresh twist on the classic Shaker style and includes innovative features to enhance the beauty of this vanity. Rollout drawers are integrated into the cabinet to make storage easier and more convenient. The White or Grey finish is complemented by Annadale knobs from Jeffrey Alexander. For available mirrors, please see pages 284–286.

PREMIUM FEATURES

- Premium undermount drawer slides feature soft-close and full-extension opening
- Hardwood drawers with strong & beautiful dovetail joinery
- Hardwood tipout trays replace false-front drawers beneath the sink
- Durable furniture-style wood construction
- Select from Jeffrey Alexander's top & bowl options to complete your design
- Lifetime warranty for original purchaser



24" VANITY



VN2SAV-24-GR-NT

FINISH	VANITY	HARDWARE	MIRROR OPTIONS
Grey	VN2SAV-24-GR-NT 24" x 21-1/2" x 35"	Satin Nickel	22" or 24" wide See pages 284–286
White	VN2SAV-24-WH-NT 24" x 21-1/2" x 35"	Matte Black	22" or 24" wide See pages 284–286

30" VANITY



VN2SAV-30-WH-NT

FINISH	VANITY	HARDWARE	MIRROR OPTIONS
Grey	VN2SAV-30-GR-NT 30" x 21-1/2" x 35"	Satin Nickel	24" or 28" wide See pages 284–286
White	VN2SAV-30-WH-NT 30" x 21-1/2" x 35"	Matte Black	24" or 28" wide See pages 284–286

36" VANITY



VN2SAV-36-GR-NT

FINISH	VANITY	HARDWARE	MIRROR OPTIONS
Grey	VN2SAV-36-GR-NT 36" x 21-1/2" x 35"	Satin Nickel	33" or smaller See pages 284–286
White	VN2SAV-36-WH-NT 36" x 21-1/2" x 35"	Matte Black	33" or smaller See pages 284–286

48" VANITY



VN2SAV-48-WH-NT

FINISH	VANITY	HARDWARE	MIRROR OPTIONS
Grey	VN2SAV-48-GR-NT 48" x 21-1/2" x 35"	Satin Nickel	33", 40" or 42" wide See pages 284–286
White	VN2SAV-48-WH-NT 48" x 21-1/2" x 35"	Matte Black	33", 40" or 42" wide See pages 284–286

60" VANITY DOUBLE BOWL



VN2SAV-60-GR-NT

FINISH	VANITY	HARDWARE	MIRROR OPTIONS
Grey	VN2SAV-60-GR-NT 60" x 21-1/2" x 35"	Satin Nickel	22" or 24" wide See pages 284–286
White	VN2SAV-60-WH-NT 60" x 21-1/2" x 35"	Matte Black	22" or 24" wide See pages 284–286

WHERE CAN I FIND THAT HARDWARE?



The decorative hardware included on this vanity is from the Annadale Collection. Find it in the Knobs & Pulls section of this catalog on page 20.

MAKING ROOM FOR NEW

The following vanity collections are being discontinued to make way for newer, trendier collections coming soon! Please contact customer service for availability while supplies last.

SILVER
LABEL

ADLER COLLECTION



SILVER
LABEL

ADDINGTON COLLECTION



SILVER
LABEL

DOUGLAS COLLECTION

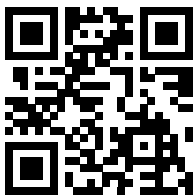

To learn more or to place an order, scan the QR code or visit <http://delivr.com/22vug>

VANITY NIGHT LIGHT KIT

L-VNLK-05-40



MOTION
ACTIVATED



PEEL & STICK
3M™ TAPE



CUT
TO SIZE



PLUG-IN
READY



IP65 RATED
WATERPROOF

36" Black Katara vanity shown
VN2KAT-36-BK-NT

Task Lighting & Power's Vanity Night Light Kit enhances the bath space and improves night-time visibility with combined LED lighting and a Doppler motion sensor switch. When the Doppler sensor detects motion, a radiant LED glow emanates beneath the vanity.

EASY TO INSTALL—No electrician required

The Doppler motion sensor can be installed inside or beneath the cabinet, completely out of sight, and detects motion up to 15 feet without direct line of sight. Installation is easy with a plug-in power supply that can be used with a new or existing outlet. Once installed, select an illumination duration from 1 minute to 4 minutes on the Doppler sensor switch based on customer preference.

TASK[™]
lighting & power

For more information on the Doppler motion sensor technology, please see pages 493–600.

hardware
resources[™]

800.463.0660
www.HardwareResources.com



SKU: L-VNLK-05-40

KIT INCLUDES:

- 60" of 120 lumens/ft. single-white, easy peel-and-stick LED tape lighting in Cool White 4000K*
- Doppler motion sensor
- 12-volt, 12-watt plug-in power supply
- 8 ft. of stranded wire
- 6-pack of EZ screw-down connectors
- Task Lighting multi-bit screwdriver
- 3M™ adhesive wipe for prepping the surface

*Can be cut to fit vanities 60" or smaller



Watch a quick overview video!

Scan the QR code or visit
<https://delivr.com/2crzv>

JEFFREY ALEXANDER[®]
by Hardware Resources

TOP IT OFF

The power of selection is yours with the largest range of vanity tops. In keeping with industry trends, we offer 3 types of vanity tops at 3 tiered price points—Quartz, Natural Stone, and Engineered Materials. Most vanity tops are cut with an 8" 3-hole faucet spread, either an oval or rectangle bowl, and include a 4" tall matching backsplash (except White Stone Resin). Optional sidesplashes are also available (see page 283).

SPECIAL TOP CONFIGURATIONS:



36" Left Offset—have a left offset bowl, so a special top is required. "CAD-ADD" is added to the part number to designate this configuration. **Example: TOPO37SGCAD-ADD**



42" Left Offset—This new top size is designated with the suffix "-LFT"
Example: TOPR43WC-LFT



60" Single Bowl—Used with the 60" single bowl vanity (Chatham collection). "61S" is added to the part number to designate this configuration. **Example: TOPO61SBO**

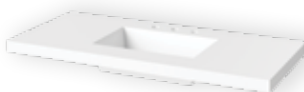

RE - White Stone Resin—This top comes with an integrated rectangle bowl and no backsplash. No bowl addition is required. **Example: TOPR37RE**



WQ - White Quartz—This top has a single-hole faucet configuration for 25" & 31" tops.
Example: TOPR31WQ-1

Vanity Top Swatch Kits

Jeffrey Alexander top swatch kits are available from your sales representative.

SKU: VNTOPSWATCH-KIT



**Ask about our
Vanity Display
Program!**

Top swatch kits are included FREE with participation in our Vanity Display Program.

BOWL OPTIONS



VN2-OVAL-15 - Oval Bowl
Used on all sizes of tops



VN2-RECT-16 - Rectangle Bowl
Used on 25" tops



VN2-RECT-19 - Rectangle Bowl
Used on all 31", 37", 43", 49", and 61" tops

For more information on porcelain bowls, see page 294.

THE BEAUTY IS IN THE DETAILS

Create the ideal space with the exact textures and beauty that the space deserves. Accentuate your bathroom design by selecting from 12 carefully curated Jeffrey Alexander tops available in an array of colors, veining, and price points.

QUARTZ



CALACATTA VIENNA QUARTZ (CQ)

This quintessential quartz pattern showcases the flow of refined veining throughout a white core. Calacatta Vienna Quartz mimics the movement of natural stone while possessing the strength and durability of quartz.

Note: The veining thickness ranges from 4 mm to 63 mm and averages between 30 mm and 50 mm thick.

Material thickness: 18 mm

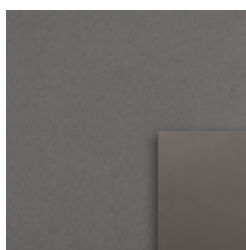

GREY QUARTZ (GQ)

Classically smooth, warm grey tones are consistent throughout the entire quartz surface. The visual versatility of grey is combined with the durability of quartz to create a vanity top that will pair well with most any vanity base finish.

Material thickness: 18 mm

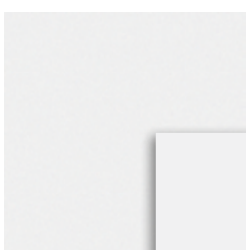

WHITE QUARTZ (WQ) **NEW**

Elevate your bathroom with the ethereal allure of White Quartz. The soft white hue and sleek surface create a tranquil ambiance, transforming your daily routines into moments of luxurious indulgence.

Material thickness: 18 mm

Only available with rectangle bowl cutout option.

Available with single hole faucet option (25" and 31" only).

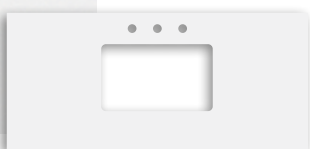

CALACATTA BLACK QUARTZ (BQ) **RETIRED**

The intense contrast of black and white is amplified in this polished Calacatta Black Quartz. Light and dark merge with the strength and durability of quartz to make a bold statement.

Note: The veining thickness ranges from 4 mm to 63 mm and averages between 30 mm and 50 mm thick.

Material thickness: 18 mm

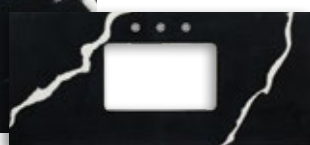

NATURAL STONE



WHITE CARRARA MARBLE (WC)

White Carrara Marble is a timeless natural stone that creates a neutral, clean space. Dark grey veining undulates throughout the stone as it weaves its way across the surface.



Material thickness: 25 mm

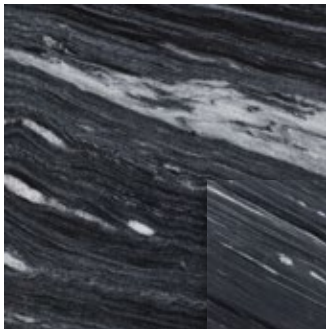

GREY MARBLE (MG)

The multitude of natural striations leads your eyes across this gorgeous surface. The grey ranges from deep charcoal to matte white and everything in between.



Material thickness: 18 mm

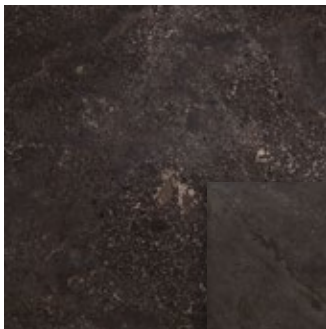

BLUE LIMESTONE (LS)

Blue Limestone exudes personality with the wide array of natural earthy tones that meld together to create a fusion of polished texture. Colors range from soft brown undertones to shale grey flecks.



Material thickness: 25 mm

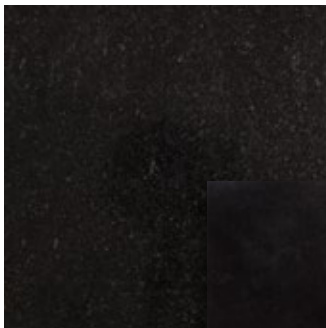

BLACK GRANITE (BG)

Golden flecks bring out the natural elements of this polished black surface. Granite continues as a trending countertop material and is a great option for bathrooms.



Material thickness: 25 mm

ENGINEERED MATERIALS



WHITE STONE RESIN (RE) *NEW*

This crisp, glossy white engineered material is made from a stone composite and features an integrated rectangular bowl, giving any vanity a sleek, contemporary feel.

Material thickness: 64 mm

Only available with an integrated rectangle bowl.

Tops for Gardner & Tempest have a single-hole faucet configuration.



ARCTIC STONE (AS) **RETIRED**

Soft specks of white and subtle striations of grey create a light and airy alabaster pattern that is incorporated throughout the entire stone.

Material thickness: 25 mm

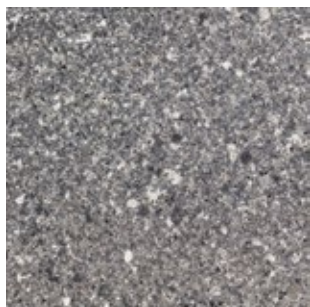

BOULDER (BO) **RETIRED**

Grey mid-tones and flecks of white blend to create a warm, deep grey visual texture that is reminiscent of majestic boulders glistening in the bright sun.

Material thickness: 25 mm



STEEL GREY (SG) **RETIRED**

Small bits of white and grey merge into a neutral salt and pepper finish. This neutral grey is spread evenly throughout, creating an ideal surface.

Material thickness: 25 mm



We have sidesplashes, too! The sidesplashes are manufactured to be universal and can be used in both left and right configurations. Each piece is 4" tall and will be the same thickness as the matching top material.

To order a sidesplash, simply choose the same material as the vanity top and use the part number key to determine the item number.

MIRRORS

The power of selection extends to choosing a mirror that coordinates with your style. Mix and match any mirror to complete the look!

16" MIRRORS



FINISH	MIRROR
Grey	MIR2CAD-16-GR 16" x 1" x 27-15/16"
White	MIR2CAD-16-WH 16" x 1" x 27-15/16"
NEW Hale Blue	MIR2CAD-16-BL 16" x 1" x 27-15/16"

22" MIRRORS



FINISH	MIRROR
Espresso	MIR2AST-22-ES 22" x 1-1/4" x 34"
White	MIR2AST-22-WH 22" x 1-1/4" x 34"

RETIRED



FINISH	MIRROR
NEW Black	MIR2CHA-22-BK 22" x 1-1/2" x 34"
Hale Blue	MIR2CHA-22-BL 22" x 1-1/2" x 34"
NEW Forest Green	MIR2CHA-22-GN 22" x 1-1/2" x 34"
Chocolate	MIR2CHA-22-CH 22" x 1-1/2" x 34"
Grey	MIR2CHA-22-GR 22" x 1-1/2" x 34"
White	MIR2CHA-22-WH 22" x 1-1/2" x 34"
NEW Blue Steel	MIR2CHA-22-BS 22" x 1-1/2" x 34"

24" MIRRORS



RETIRED

FINISH	MIRROR
Black	MIR2ADL-24-BK 24" x 1-1/2" x 28"
Forest Green	MIR2ADL-24-GN 24" x 1-1/2" x 28"
White	MIR2ADL-24-WH 24" x 1-1/2" x 28"



FINISH	MIRROR
Black	MIR2CAD-24-BK 24" x 1" x 28"
Hale Blue	MIR2CAD-24-BL 24" x 1" x 28"
Blue Steel	MIR2CAD-24-BS 24" x 1" x 28"
Forest Green	MIR2CAD-24-GN 24" x 1" x 28"
Grey	MIR2CAD-24-GR 24" x 1" x 28"
White	MIR2CAD-24-WH 24" x 1" x 28"
Weathered Grey	MIR2CAD-24-WG 24" x 1" x 28"
NEW Dark Walnut	MIR2CAD-24-DW 24" x 1" x 28"
NEW Natural Oak	MIR2CAD-24-NO 24" x 1" x 28"



FINISH	MIRROR
Black	MIR2CAD-22-BK 22" x 1" x 28"
Hale Blue	MIR2CAD-22-BL 22" x 1" x 28"
Blue Steel	MIR2CAD-22-BS 22" x 1" x 28"
NEW Forest Green	MIR2CAD-22-GN 22" x 1" x 28"
Grey	MIR2CAD-22-GR 22" x 1" x 28"
White	MIR2CAD-22-WH 22" x 1" x 28"
Weathered Grey	MIR2CAD-22-WG 22" x 1" x 28"
NEW Dark Walnut	MIR2CAD-22-DW 22" x 1" x 28"
NEW Natural Oak	MIR2CAD-22-NO 22" x 1" x 28"

28" MIRRORS



RETIRED

FINISH	MIRROR
Espresso	MIR2AST-28-ES 28" x 1-1/4" x 34"



FINISH	MIRROR
NEW Black	MIR2CHA-28-BK 28" x 1-1/2" x 34"
Hale Blue	MIR2CHA-28-BL 28" x 1-1/2" x 34"
Chocolate	MIR2CHA-28-CH 28" x 1-1/2" x 34"
Forest Green	MIR2CHA-28-GN 28" x 1-1/2" x 34"
Grey	MIR2CHA-28-GR 28" x 1-1/2" x 34"
White	MIR2CHA-28-WH 28" x 1-1/2" x 34"
NEW Blue Steel	MIR2CHA-28-BS 28" x 1-1/2" x 34"

33" MIRRORS



FINISH	MIRROR
Black	MIR2CAD-33-BK 33" x 1" x 28"
Hale Blue	MIR2CAD-33-BL 33" x 1" x 28"
Blue Steel	MIR2CAD-33-BS 33" x 1" x 28"
Forest Green	MIR2CAD-33-GN 33" x 1" x 28"
Grey	MIR2CAD-33-GR 33" x 1" x 28"
White	MIR2CAD-33-WH 33" x 1" x 28"
Weathered Grey	MIR2CAD-33-WG 33" x 1" x 28"
NEW Dark Walnut	MIR2CAD-33-DW 33" x 1" x 28"
NEW Natural Oak	MIR2CAD-33-NO 33" x 1" x 28"

40" MIRRORS



FINISH	MIRROR
NEW Black	MIR2CHA-40-BK 40" x 1-1/2" x 34"
Hale Blue	MIR2CHA-40-BL 40" x 1-1/2" x 34"
Chocolate	MIR2CHA-40-CH 40" x 1-1/2" x 34"
Grey	MIR2CHA-40-GR 40" x 1-1/2" x 34"
White	MIR2CHA-40-WH 40" x 1-1/2" x 34"
NEW Blue Steel	MIR2CHA-40-BS 40" x 1-1/2" x 34"

MIRROR FRAME FINISHES



MIRRORS

The power of selection extends to choosing a mirror that coordinates with your style. Mix and match any mirror to complete the look!

NEW

Jeffrey Alexander's new minimalistic metal frame mirrors add a luxurious touch to bathroom décor with clean lines and trendy style. These mirrors are crafted from durable steel, finished with meticulous attention to detail, and feature premium glass with a shatter-proof backing. Hanging mirrors is easy with our new wide, durable mounting system.



VMIR-METC-30BG



VMIR-METR-22MB



VMIR-METR-24SBZ

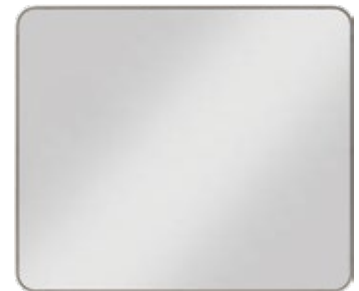

VMIR-METR-33SN

FINISH	MIRROR
Brushed Gold	VMIR-METC-30BG 30" x 1"
Matte Black	VMIR-METC-30MB 30" x 1"
Satin Bronze	VMIR-METC-30SBZ 30" x 1"
Satin Nickel	VMIR-METC-30SN 30" x 1"

FINISH	MIRROR
Brushed Gold	VMIR-METR-22BG 22" x 1" x 30"
Matte Black	VMIR-METR-22MB 22" x 1" x 30"
Satin Bronze	VMIR-METR-22SBZ 22" x 1" x 30"
Satin Nickel	VMIR-METR-22SN 22" x 1" x 30"

FINISH	MIRROR
Brushed Gold	VMIR-METR-24BG 24" x 1" x 30"
Matte Black	VMIR-METR-24MB 24" x 1" x 30"
Satin Bronze	VMIR-METR-24SBZ 24" x 1" x 30"
Satin Nickel	VMIR-METR-24SN 24" x 1" x 30"

FINISH	MIRROR
Brushed Gold	VMIR-METR-33BG 33" x 1" x 28"
Matte Black	VMIR-METR-33MB 33" x 1" x 28"
Satin Bronze	VMIR-METR-33SBZ 33" x 1" x 28"
Satin Nickel	VMIR-METR-33SN 33" x 1" x 28"

— MIRROR FRAME FINISHES —

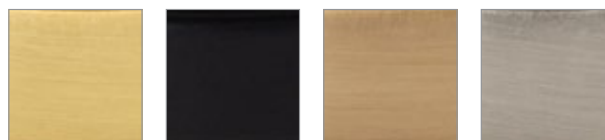

(BG) Brushed Gold (MB) Matte Black (SBZ) Satin Bronze (SN) Satin Nickel

VANITY SELECTION GUIDE



SKU: CATVANSLCT23-1

SHOWROOM DISPLAY

Ask your sales representative for special pricing discount on vanity displays!



Dashwood Collection
 Vanity: VN2DAS-36-WH-NT
 Top: Not Shown
 Bowl: Not Shown
 Mirror: VMIR-METR-33BG

VANITY ORDERING TOOL



VANITY CONFIGURATOR



VANITY SWATCH KITS



SKU: VNWATCH-KIT



SKU: VNTOPSWATCH-KIT

For more information on these helpful resources, contact your local sales representative.

FINISH KEY

	Black	Blue Steel	Chocolate	Dark Walnut	Espresso	Forest Green	Grey	Hale Blue	Natural Oak	Weathered Grey	White
24" Astoria*					•		•				•
30" Astoria*					•		•				•
36" Astoria*					•		•				•
48" Astoria*					•		•				•
18" Cade							•				•
24" Cade	•						•				•
30" Cade	•						•				•
36" Cade	•				•		•	•			•
48" Cade	•						•	•			•
60" Cade (Double)	•						•				•
18" Chatham							•	•			•
24" Chatham		•	•				•	•			•
30" Chatham		•	•			•	•	•			•
36" Chatham		•	•				•	•			•
48" Chatham		•	•				•	•			•
60" Chatham (Single)			•				•				•
60" Chatham (Double)			•				•				•
24" Dashwood				•					•		•
30" Dashwood		•		•					•		•
36" Dashwood		•		•					•		•
42" Dashwood				•					•		•
48" Dashwood		•		•					•		•
60" Dashwood (Double)				•					•		•
30" Gardner		•		•					•		•
36" Gardner		•		•					•		•
48" Gardner		•		•					•		•
30" Kipling	•			•					•		•
36" Kipling	•			•					•		•
48" Kipling	•			•					•		•
60" Kipling (Double)	•			•					•		•
24" Jubilee				•			•		•	•	•
30" Jubilee				•			•		•	•	•
36" Jubilee				•			•		•	•	•
42" Jubilee				•			•		•	•	•
48" Jubilee				•			•		•	•	•
60" Jubilee (Double)				•			•		•	•	•
24" Katara	•						•	•			•
30" Katara	•	•				•	•	•			•
36" Katara	•	•				•	•	•			•
42" Katara	•	•				•	•	•			•
48" Katara	•	•				•	•	•			•
60" Katara (Double)	•					•	•				•

	Black	Blue Steel	Chocolate	Dark Walnut	Espresso	Forest Green	Grey	Hale Blue	Natural Oak	Weathered Grey	White
24" Pascal				•			•		•	•	•
30" Pascal		•		•			•		•	•	•
36" Pascal		•		•			•		•	•	•
42" Pascal				•			•		•		•
48" Pascal		•		•			•		•	•	•
60" Pascal (Double)				•			•		•	•	•
24" Percival	•						•	•			•
30" Percival	•						•	•			•
36" Percival	•						•	•			•
24" Savino*							•				•
30" Savino*							•				•
36" Savino*							•				•
48" Savino*							•				•
60" Savino (Double)*							•				•
30" Tempest		•		•					•		•
36" Tempest		•		•					•		•
48" Tempest		•		•					•		•
24" Theodora	•	•					•	•			•
30" Theodora	•	•					•	•	•		•
36" Theodora	•	•					•	•	•		•
48" Theodora	•	•					•	•	•		•
60" Theodora (Double)	•	•					•	•			•
24" Wavecrest							•			•	•
30" Wavecrest							•	•	•		•
36" Wavecrest							•	•	•		•
48" Wavecrest							•	•	•		•
60" Wavecrest (Double)							•			•	•

*This collection is retired. Call for availability.

Kitchen & Bath Sinks

Stainless Steel Sinks

In the kitchens of today's modern homes, we no longer find just a cook, we find aspiring chefs. All great chefs need a handy helper, space, and convenience. Find just that in a Stainless Steel Sink from Hardware Resources.



All Hardware Resources Stainless Steel Sinks are:

- Made of high-quality materials—SUS304 Stainless Steel, with 18/8 chromium/nickel content, has a high resistance to rust, corrosion, and oxidation.
- Insulated—Strong and quiet, these sinks have an added layer of insulation on the bottom to reduce sound.
- Durable—Reinforced plates on the sides and bottom of the sink help prevent bending or buckling.
- Manufactured responsibly—Care has been taken to protect the environment while providing an easy-to-clean, quality product.
- UPC Certified—These codes are designed to provide consumers with safe and sanitary plumbing systems. Unless otherwise specified, all stainless steel sinks are UPC Certified.
- Lifetime Warranty—Hardware Resources believes in quality, integrity, and reliability by offering a lifetime warranty on all of our Stainless Steel Sinks and accessories (see page 300).



Complies with ASME
A112.19.3-2008/CSA
B45.4-08



Sinks

Stainless Steel Sinks

Apron-Front/Farmhouse.....	290
Premium Handmade	291
Premium	292
Economy.....	292
Accessories (Strainer).....	292
Utility & Bar	293

Porcelain Vanity Sinks

Oval Vanity Sinks	295
Rectangle Vanity Sinks	295
Specifications.....	296-299
Care & Cleaning.....	300
Warranty	300

Mounting Kits

All stainless steel sinks ship with mounting kit and a paper template.

DXF cutting template files are available for download at www.HardwareResources.com.

Premium Stainless Steel Sinks



HA200 shown in use



HA225 shown in use

APRON-FRONT/FARMHOUSE

304 SS with Satin Finish • Insulated Bottom • UPC Certified



HA200 - 16-Gauge
Stainless Steel
Apron-Front/Farmhouse Sink
35-7/8" L x 20-3/4" W x 10" D

*Grid sold separately (HA200-GRID)
Strainer sold separately (STRAINER-200)*



HA225 - 16-Gauge
Stainless Steel
Apron-Front/Farmhouse Sink
with two unequal bowls
35-7/8" L x 20-3/4" W x 10" D

*Grid sold separately (HA225-GRID)
Strainer sold separately (STRAINER-200)*

See pages 296-299 for specifications and dimensions.

PREMIUM HANDMADE

304 SS with Satin Finish • Insulated Bottom • UPC Certified



HMS190 & HMS190-GRID shown in use



HMS250 - 16-Gauge
Stainless Steel Undermount Sink
with two equal bowls
32" L x 19" W x 10-3/8" D
*Grid sold separately (HMS250-GRID)
Strainer sold separately (STRAINER-200)*



HMS260L - 16-Gauge
Stainless Steel Undermount Sink
with two unequal bowls
32" L x 19" W x 10-3/8" D
*Grid sold separately (HMS260-GRID)
Strainer sold separately (STRAINER-200)*



HMS200 - 16-Gauge
Stainless Steel Undermount Sink
32" L x 19" W x 10-3/8" D
*Grid sold separately (HMS200-GRID)
Strainer sold separately (STRAINER-200)*



HMS190 - 16-Gauge
Stainless Steel Undermount Sink
30" L x 18" W x 10-3/8" D
*Grid sold separately (HMS190-GRID)
Strainer sold separately (STRAINER-200)*



HMS175 shown in use



HMS175 - 16-Gauge
Stainless Steel Undermount Sink
23" L x 18" W x 10-3/8" D
*Grid sold separately (HMS175-GRID)
Strainer sold separately (STRAINER-200)*

**See pages 296-299
for specifications
and dimensions.**

Stainless Steel Sinks

PREMIUM

304 SS with Satin Finish • Insulated Bottom • UPC Certified

**801L** - 16-Gauge

Stainless Steel Undermount Sink
with two unequal bowls
(larger bowl on left)

32" L x 20-3/4" W x 9" D*Strainer sold separately (STRAINER-200)***802** - 16-Gauge

Stainless Steel Undermount Sink
with two equal bowls

32-1/4" L x 18-1/2" W x 9" D*Strainer sold separately (STRAINER-200)*

802 shown in use

ECONOMY

304 SS with Satin Finish • Insulated Bottom • UPC Certified

**807L** - 18-Gauge

Stainless Steel Undermount Sink
with two unequal bowls
(larger bowl on left)

31-1/2" L x 20-1/2" W x 9" D*Strainer sold separately (STRAINER-200)***801L-18/801R-18** - 18-Gauge

Stainless Steel Undermount Sink
with two unequal bowls
(larger bowl on left (801L)
or right (801R))

32" L x 20-5/8" W x 9" D*Strainer sold separately (STRAINER-200)***802-18** - 18-Gauge

Stainless Steel Undermount Sink
with two equal bowls

32-1/4" L x 18-1/2" W x 9" D*Strainer sold separately (STRAINER-200)***868** - 18-Gauge

Stainless Steel Rectangular
Undermount Sink

30" L x 18" W x 9" D*Strainer sold separately (STRAINER-200)***910-1*** - 20-Gauge

Stainless Steel Drop-in Sink
with two equal bowls

33" L x 22" W x 9" D*Strainer sold separately (STRAINER-200)*

**See pages 296-299 for
specifications and dimensions.**

ACCESSORIES

**STRAINER-200**

Stainless Steel Sink Strainer
for 3-1/2" Drain Openings

**Does not comply with UPC Certification*



861 shown in use

UTILITY & BAR

304 SS with Satin Finish • Insulated Bottom • UPC Certified



861 - 18-Gauge
Stainless Steel Large D-Bowl
Undermount Sink
23-1/4" L x 20-7/8" W x 9" D
Strainer sold separately (STRAINER-200)



862 - 18-Gauge
Stainless Steel
Undermount Sink
23-1/2" L x 17-3/4" W x 9" D
Strainer sold separately (STRAINER-200)



863* - 18-Gauge
Stainless Steel D-Bowl
Undermount Sink
19-3/4" L x 20-1/2" W x 9" D
Strainer sold separately (STRAINER-200)



869 - 18-Gauge
Stainless Steel
Undermount Bar Sink
14-1/2" L x 13" W x 7" D
Strainer sold separately (STRAINER-200)



869 shown
in use

**See pages 296-299 for
specifications and dimensions.**

Porcelain Vanity Sinks

In today's bathrooms, sinks need to hold up against life yet still look sophisticated and elegant. Hardware Resources offers just that in our undermount Porcelain Vanity Sinks with the classic oval and the more trendy rectangle designs, both offered in two popular sizes.



H8810WH shown in use

For beautiful furniture-style vanities that coordinate with these sinks, please see page 229.

All Hardware Resources Porcelain Vanity Sinks are:

- Designed with the customer in mind—Featuring a deep bowl, our Porcelain Vanity Sinks allow more usable space and include an overflow drain.
- Made of high-quality materials—Porcelain is durable, easy-to-clean, and resistant to corrosion.
- Manufactured responsibly—Care has been taken to protect the environment while providing a quality product.
- UPC Certified—These codes are designed to provide consumers with safe and sanitary plumbing systems. All porcelain sinks are UPC Certified.
- Lifetime Warranty—Hardware Resources believes in quality, integrity, and reliability by offering a lifetime warranty on all of our porcelain sinks (see page 300).



Complies with ASME
A112.19.3-2008/CSA
B45.4-08



Mounting Kits

All porcelain sinks ship with mounting kit and a paper template.

DXF cutting template files are available for download at www.HardwareResources.com.



H8910WH shown in use

PORCELAIN VANITY

Highly Durable Porcelain • Overflow Drain • UPC Certified



H8809 - Parchment[†]
Small Oval Porcelain
Undermount Sink
17-1/2" L x 14-9/16" W x 7" D



H8809WH - White
Small Oval Porcelain
Undermount Sink
17-1/2" L x 14-9/16" W x 7" D



H8909WH - White
Small Rectangle Porcelain
Undermount Sink
18-1/8" L x 12" W x 6-7/8" D



H8810 - Parchment[†]
Large Oval Porcelain
Undermount Sink
19-11/16" L x 15-3/4" W x 6-7/8" D



H8810WH - White
Large Oval Porcelain
Undermount Sink
19-11/16" L x 15-3/4" W x 6-7/8" D



H8910WH - White
Large Rectangle Porcelain
Undermount Sink
20-7/8" L x 13-3/8" W x 6-7/8" D

See pages 296-299 for specifications and dimensions.

Specifications & Dimensions

APRON-FRONT/FARMHOUSE

Undermount/Flush Mount

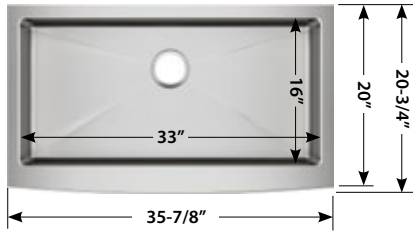
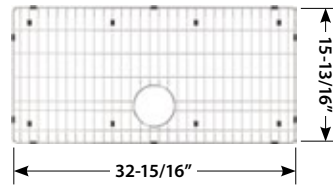
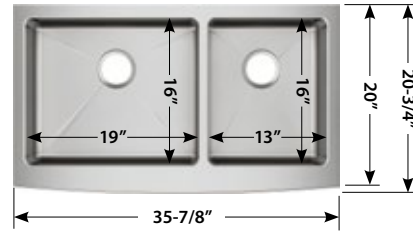
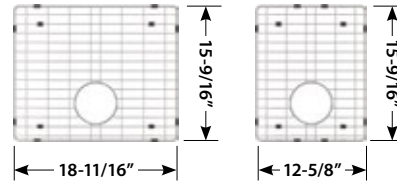
HA200**HA200-GRID****HA225****HA225-GRID**

PREMIUM HANDMADE

Undermount

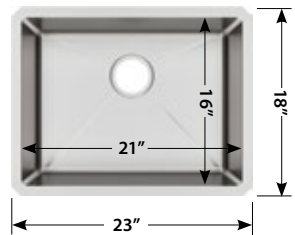
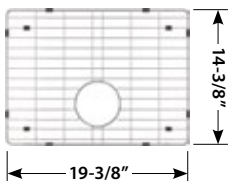
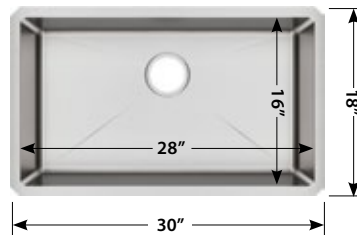
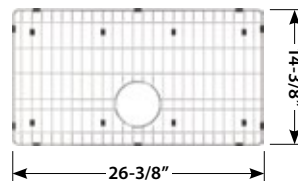
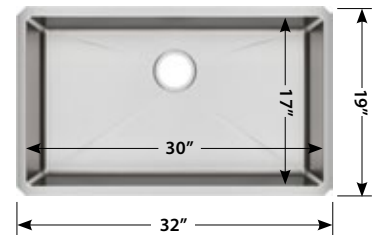
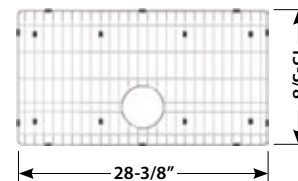
HMS175**HMS175-GRID****HMS190****HMS190-GRID****HMS200****HMS200-GRID**

PREMIUM HANDMADE

Undermount

HMS250

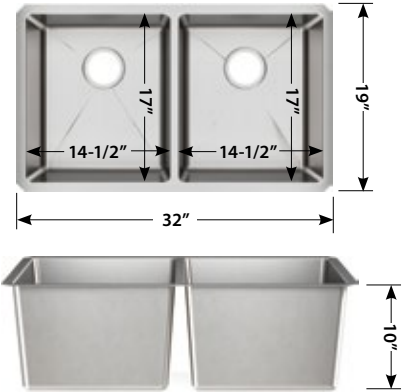

HMS260L

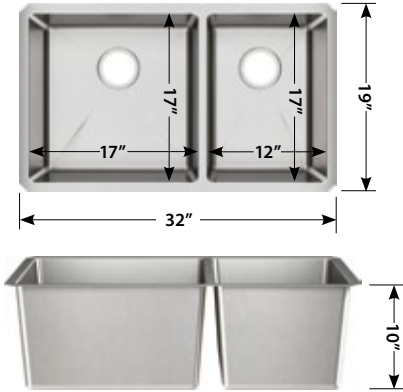

HMS250-GRID

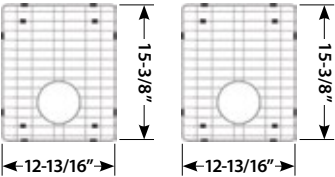

HMS260-GRID

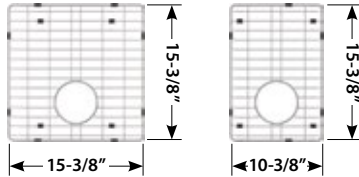

PREMIUM

Undermount

801L

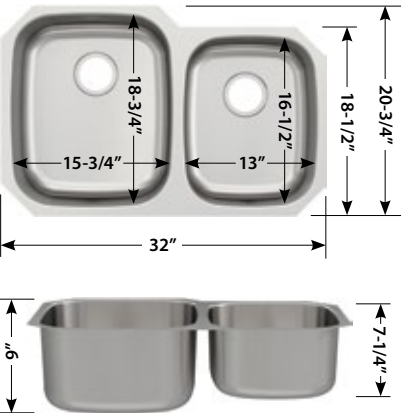

802

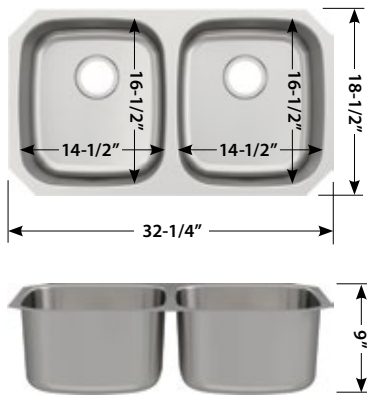

Specifications & Dimensions

ECONOMY

Undermount (except 910-1 which is drop-in)

801L-18

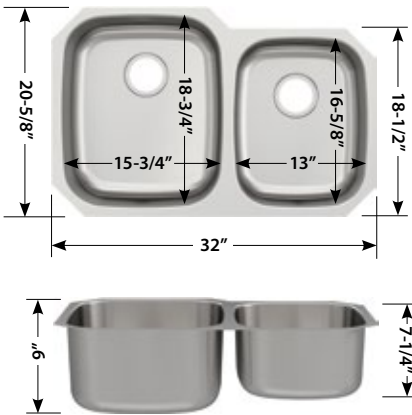

801R-18

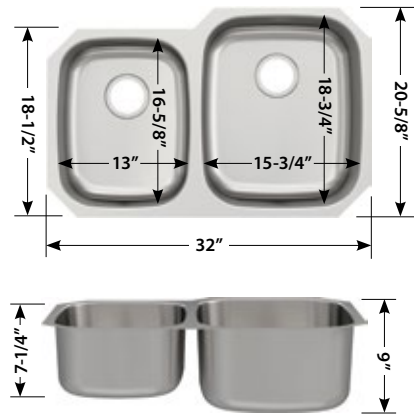

802-18

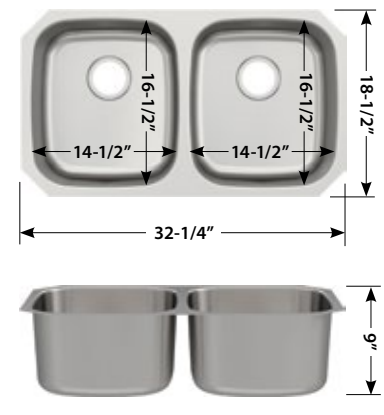

807L

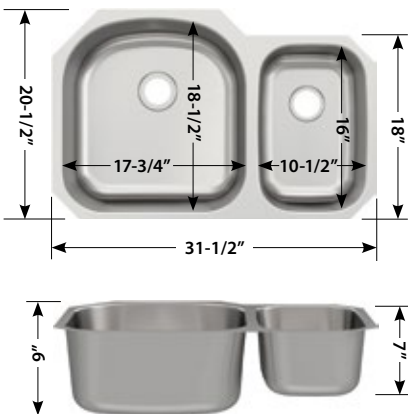

868

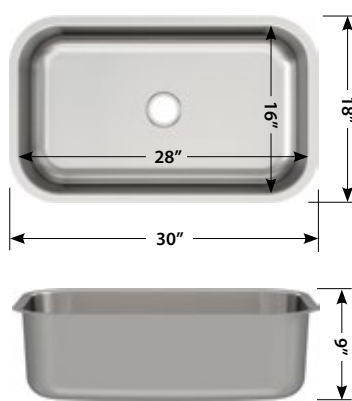

910-1

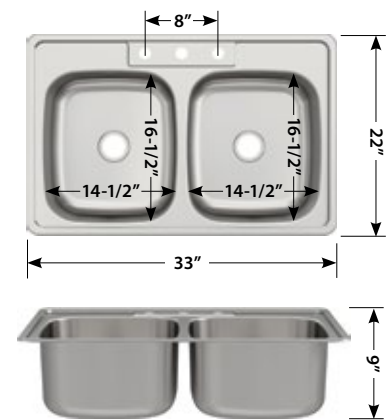

UTILITY & BAR

Undermount

861



862

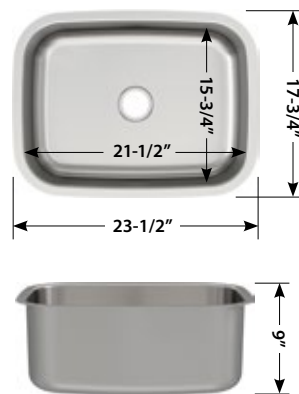

863

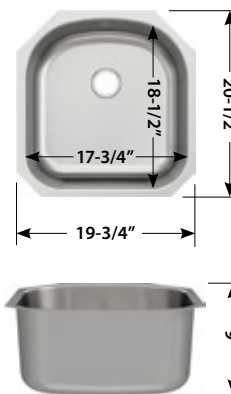

869

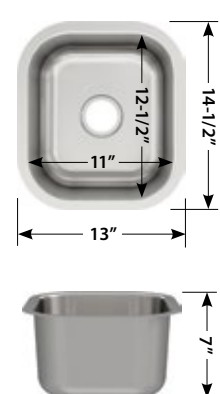

ACCESSORIES

STRAINER-200



PORCELAIN VANITY

Undermount

H8809/H8809WH

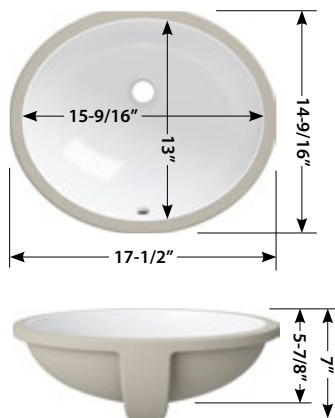

H8810/H8810WH

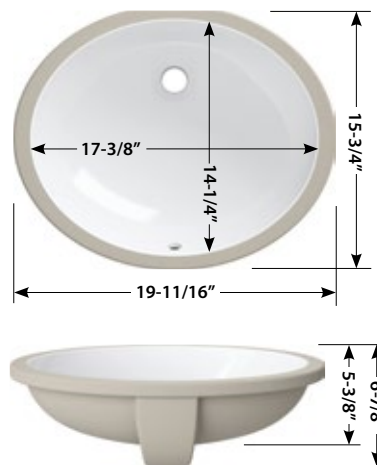

H8909WH

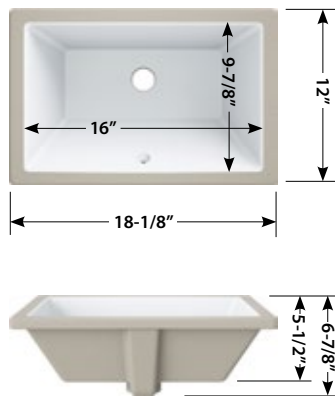

H8910WH

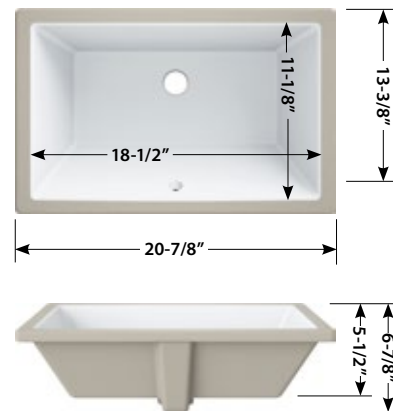

Care & Cleaning

Do:

1. When it comes to maintenance, the best thing is to be consistent in cleaning. Frequent light cleaning is preferable to heavy-duty cleaning every once in a while.
2. Make sure the sink is clean and dry when not in use. This is the best method of preventative maintenance.
3. Keep the drain clog-free to prevent standing water, which can lead to mineral deposit build up. If a mineral build up should occur, use a mixture of vinegar and hot water to remove the deposit.
4. To clean the stainless steel sink, use a non abrasive cleaning cloth combined with a mild cleaning product or baking soda. For tougher stains use a mild abrasive cleaner like Barkeeper's Friend™, Ajax™ or Comet™.
5. Follow the direction of the stainless steel grain when cleaning or scrubbing stains because scrubbing against the grain will show as a scratch.



Do Not:

1. Don't leave soaps and other cleaners in the sink overnight. Do not use solutions with bleach in the sink. All of these items contain chemicals that may damage the sink if left on the surface.
2. Don't use steel wool on the sink. If aggressive cleaning is needed, use a Scotch-Brite pad and rub in the direction of the satin finish lines.
3. Don't leave bars of soap, wet sponges or cleaning pads on the faucet ledge. These items over time will dull and possibly pit the surface of the sink.
4. Don't leave salt, vinegar, citrus fruit juices, mustard, or pickles on the sink; wipe them up immediately as they contain citric acids. Over time, these items can etch the surface.
5. Don't leave any steel or cast iron cookware in the sink for a long period of time. This may also leave iron particles that will corrode the sink.
6. Don't use Lime-A-Way™ or similar cleaners as they will damage the sink's surface and cause rusting.



Product Warranty

Hardware Resources believes in quality, integrity, and reliability. We uphold the highest standards of service and responsibility in the industry.

As such, Hardware Resources warrants all stainless steel and porcelain sinks against defects in material and workmanship as long as the original consumer purchaser owns the products, if the original consumer purchased the products from an authorized distributor of Hardware Resources. Hardware Resources cannot guarantee the quality or condition of products from distributors who do not agree to meet our high standards, and therefore, no warranty is provided for products from unauthorized sellers.

If the finish of any of these items tarnishes, corrodes, rusts, begins to chip or rub off or has any other defect, Hardware Resources will send to the original purchaser, a new replacement product of the same or comparable style and quality at no charge. If a replacement is no longer available, Hardware Resources will refund to the original purchaser, the current wholesale value of the sink.

This warranty is a warranty of replacement only. Hardware Resources specifically does not warrant removal of the product nor installation of replacement new product. This warranty does not apply when the item has been tampered with, misused, improperly installed, altered from the original form, or damaged through improper cleaning, abuse or accident.

In the unlikely event that a defective stainless steel sink is encountered, please contact Customer Service at 800.463.0660. Please be able to provide a brief description and photographs of the defect.

Organizers

Cabinet Organizers

Waste Container Organization

NEW Wood Bottom-Mount Trash Can Pullout with Door Kit	318-319
NEW Wood Bottom-Mount Trash Can Pullout for Hinged Doors	321
Metal Drawer Box Trash Can Pullout	322
Storage with Style® Trash Can Pullout	323
Wood Top Mount with Soft-close	324-325
Economy Soft-close Trash Can Pullout	326
Wire Bottom Mount	327
Cans & Lids	328

Base Cabinet Organization

"No Wiggle" Base Pullout	333-334
"No Wiggle" Knife Block Pullout	335
"No Wiggle" Utensil Pullout	336
"No Wiggle" Drawer Base Pullout	337
"No Wiggle" Tray Divider Pullout	338
"No Wiggle" Base Filler Pullouts	339
Peg Board Filler Pullout	340
Appliance Lift	341
NEW Double-Drawer Bottle Rollout	343
NEW Single and Double-Drawer Cookware Rollouts	344-345
Easy-to-Install Rollout Drawers	346
NEW Under-Sink Silicone Mat	347

Corner Organization

Blind Corner Swingout	350-351
Blind Corner Sliding Door	352-353
Easy 360 Susan	354-355
Storage with Style® Blind Corner Pullout	356-357
Premium Wood Lazy Susan Kits	358-359
Premium Wood Lazy Susan Shelves & Poles	360-361
Premium Wood Swivel Lazy Susan	362
Economy Wire Swivel Lazy Susan	363
Economy Banded Swivel Lazy Susan	364
Economy Banded Lazy Susan Kits	365
Plastic Lazy Susan with Chrome Hub Kits	366
Economy Plastic Lazy Susan Kits	367
Plastic Pie-cut Lazy Susan	368
Half-moon Lazy Susan	369

Pantry Organization

Premium Chrome Swingout	374-375
Premium Chrome Pullout	376
Wood Pullout	377
Wood Swingout	378
Wood Door Mount	379
Build Your Own Rollouts	380
Quick Tray Pilaster System	381
Dovetail Drawer Boxes & Linear Material	382-383
Slide Mounting Kit for Ball Bearing Slides	384
Rear Mounting Block for Undermount Slides	385

Drawer Organization

Double Cutlery Drawer	388
Angled Utensil Insert	389
Cutlery Insert	390
NEW SlimLine Cutlery Insert	391
Knife Block Insert	392
Spice Tray Insert	393
NEW Double Coffee Drawer	394
NEW Adjustable Drop-In Coffee Pod Insert	395
Peg Board Insert	396
Peg Board Accessories	397
Tipout Tray & Kits – Stainless Steel	398
Tipout Tray & Kits – White	399

Wall Cabinet Organization

"No Wiggle" Wall Pullout	402
Wall Filler Pullout	403
Wire Tray Divider	404
Wooden Tray Divider	405
Door Mounted Spice Racks	406

Wooden Stemware Rack	407
Wooden Wine Bottle Lattice	408
Wooden Bottle Rack & Wire Stemware	409

Storage with Style®

Blind Corner Pullout	412-413
Base Pullout	414
Drawer Base Pullout	415
Utensil Base Pullout	416
Pot & Lid Organizer Pullout	417
Trash Can Pullout	418
Pullout Basket & Pilaster System	419

Easy to Install Organizers

Pullout Baskets	421
Trash Can Pullouts	422
Trash Cans & Lids	423
Cleaning Supply Caddy	424
Pullout Pot & Lid Organizers	425
Door Mounted Tray System	426
Single Shelf Lazy Susan	427
3-Tier Spice Pulldown	428
Sink Front Tipout Trays	429
Under Cabinet Stemware Rack	430
Under Cabinet Bottle Rack	430
U-Shaped Tray Divider	431
3-Tier Dishcloth Rack	431
Over the Door Towel Bar	431

Bathroom Organization

Powered Vanity Drawer	436-437
"No Wiggle" Vanity Pullout	438-439
NEW Wood Bottom-Mount Soft-Close Vanity Trash Can Pullout	440
NEW SlimLine Vanity Drawer Inserts	441
Wire Cleaning Supply Caddy	442
Wire Basket Rollout	443
Easy-to-Install Rollout Drawers	444

NorthPoint Cabinetry®

Cross Reference Guide 445-451

Closet Organizers

Shoe Fence	456
Pullout Baskets	457-459
Pullout Nylon Hamper	460
Pullout Plastic Hamper	461
Pullout Pant Rack	462
14" Belt Rack	463
14" Tie Rack	463
Tri-Level Tie Organizer	464
Cascading Tie Organizer	465
12" Sliding Belt & Tie Racks	466
Valet Rod	466
Screw-Mount Racks	467
Telescoping Valet Rod	468
Laundry Valet	469
Wardrobe Lifts	470-471
Jewelry Trays	472
Hooks	473
Oval Closet Rods	474-475
Round Closet Rods	476-479
Task Lighting & Power Products for Closets	480-483
Custom Dovetail Drawer Boxes for Closets	484-485
Shelf Supports	486-490
Heavy-duty Shelf Utility Bracket	491

What's New in Organizers?



NEW Wood Bottom-Mount Soft-Close Vanity Trash Can Pullout

Neatly tuck away trash cans underneath a vanity with this beautiful solid wood soft-close trash can pullout. A convenient storage area allows for storage of trash can liners, paper towels, or cleaning solutions. The trash cans are available in black, grey, and white.

See details on page 440

NEW 21" Wood Bottom-Mount Soft-Close Trash Can Pullout with Door Kit

Neatly tuck away trash cans with this beautiful solid wood soft-close trash can pullout. Behind two side-by-side 35 qt. trash cans is a convenient storage area for organization of trash can liners, paper towels, or cleaning solutions. The trash cans are available in black, grey, and white.

See details on page 318



NEW Under-Sink Silicone Mat

Protect sink base cabinets from damage caused by water leaks. High-quality grey silicone material is easy to clean and features a stylish honeycomb pattern.

See details on page 347



What's New in Organizers?

NEW Adjustable Drop-In Coffee Pod Drawer Insert



Maximize storage of coffee pods and accessories in an existing drawer with a drop-in organizer. Available in two convenient sizes and fits a variety of drawer widths.

See details on page 395

NEW Double Coffee Drawer



Create a dedicated coffee storage drawer with this fully assembled drawer replacement organizer. Features a top tier for coffee pods and a bottom tier for additional item storage.

See details on page 394

NEW Drop-in Drawer Inserts for Kitchen & Bath



Tame drawer clutter in the kitchen with cutlery inserts, now available with slimmer material profiles.

See details on page 391



Bathroom vanity drawers are more organized than ever with this drop-in insert for cosmetics, shaving supplies, hair accessories, and more.

See details on page 441

Maximize every inch

Wall Storage Solutions

Maximize cabinet storage with wall cabinet solutions. From cabinet pullouts and bakeware organizers to spice racks and wine accessories, we can help you create the most beautiful and organized kitchen.

Corner Solutions

Conquer corner cabinet clutter with lazy susans that spin to bring goods stored at the back of the cabinet to your fingertips.

Pullout Solutions

Organize cookware, bakeware, knives, utensils, bottles, boxes, and more with our wide variety of base cabinet pullouts and rollouts.

of your new kitchen

Drawer Solutions

Tame drawer clutter with quality wood drawer organizers. From complete drawer solutions to drop-in inserts, these products will help organize everything from cutlery to spices.

Waste Container Solutions

Neatly tuck away trash cans with a waste container solution. With our range of styles and materials, we have a solution that will enhance your design and optimize the budget.

PULLOUT SOLUTIONS

Maximize cabinet storage with Hardware Resources' base cabinet solutions. From cabinet pullouts to mixer lifts, we can help you make the most of a beautiful and organized kitchen.



KBPO-85C
Page 335

"No Wiggle" Knife Block Pullout

Keep knives stored away with this innovative pullout featuring a magnetic slot that won't dull your blades.



BPO2-55C
Pages 333

"No Wiggle" Pullout

The star of the kitchen!

Bring your cabinet contents within easy reach. Our patented design eliminates the wiggle, keeping your contents secure.



ROBTD21-WB
Page 343

Water Bottle Rollout

This innovative rollout features a 15-bottle grid to neatly and securely store bottles of all kinds.



ROCWD21-WB
Page 345

Cookware Rollout

Home cooks will appreciate the easy vertical access to all of their cookware and the optional top drawer for accessories.



ML-1CH
Page 341

Appliance Lift with Soft-Close

No more lifting heavy appliances — let our lift bring your mixer, coffee machine, air fryer, or other appliance to counter level.

WASTE CONTAINER SOLUTIONS



Premium Wood Bottom Mount with Door Kit
Beautiful solid wood drawer box with concealed soft-close slides and patented door mounting system.

Neatly tuck away trash cans with a Hardware Resources waste container solution. From top or bottom mount options to premium wood or economy wire, we have a solution that will enhance your design and optimize the budget.



Storage with Style® Trash Can Pullout
Tuck away trash cans in style with two trending finish options. See pages 308-319 for coordinating full product offering.



Economy Wire Trash Can System
Practical and versatile with three finish options.



Premium Wood Bottom Mount
Beautiful solid wood drawer box with concealed soft-close slides.



Wood Top Mount Trash Can System
Low profile design, soft-closes into cabinet with mounted door.

PANTRY SOLUTIONS

Organize everyone's favorite spot in the kitchen with a Hardware Resources pantry solution. From the traditional pantry pullout to our innovative pantry swingout, we have a solution for pantry storage needs.



PSO45 & PDM45 (2)
Pages 378-379

Premium Wood Swingout and Door Mount Shelves

Gain full access to all your pantry items with swingout and door mounted shelves.



PP02-1448
Page 377

Premium Wood Pullout

Natural solid wood pullout on heavy-duty slides.



CPP01563SC
Page 376

Premium Chrome Pullout

Heavy-duty soft-close pantry pullout with stylish chrome accents.



Premium Chrome Swingout

Pivots 90 degrees when fully extended, making the back of the pantry easily accessible.



CPS01574SC
Pages 375

is how you **Organize It**

DRAWER SOLUTIONS

Tame drawer clutter with Hardware Resources' drawer organizers. From complete drawer solutions to drop-in inserts, these products will help organize everything from cutlery to cookware.



KCCO15
Page 395

Adjustable Drop-In Coffee Pod Drawer Insert

Maximize storage of coffee pods and accessories in an existing drawer with a drop-in organizer.



KNCD21
Page 394

Double Coffee Drawer

Double drawer maximizes storage while keeping coffee pods organized and out of sight.



PEG-9
Page 396

Pegboard Organizer Insert

Beautiful solid wood pegboard drops into drawer for customizable organization.



SPO15-B18
Page 393

Spice Tray Drawer Insert

Tiered and tilted design allows you to easily see your spices.



CO21A
Page 391

SlimLine Cutlery Drawer Insert

Beautiful natural wood divider simply drops into drawer.



KO18-B21
Page 392

Knife Block Drawer Insert

Get your knife block off the counter and into your drawer with this knife block insert.

CORNER SOLUTIONS

With Hardware Resources' blind corner solutions, unused cabinet space is a thing of the past. The variety of available options ensures that we have a solution that will fit your design and style.



Also available in white plastic

HMLS-W-3212
Page 369

Half-Moon Lazy Susan

Shelves pivot then slide out for full access in hard to reach blind corners. Available in wood and plastic options to meet any budget.



PLSK232
Page 367

Plastic Lazy Susan

Economical and easy-to-clean plastic trays rotate 360 degrees in either base or wall cabinets.



LSR218-SET
Pages 359

Premium Wood Lazy Susan

360 degree rotation brings rear storage to the front in either base or wall cabinets.



BCS0215PCMP-LH
Pages 351

Blind Corner Swingout

Double shelves that independently pull out of the cabinet allow easy access to the back of the cabinet.



SWS-BCS15BN
Pages 357

Storage with Style® Blind Corner Pullout

With a universal design for left or right-hand blind corners, all four baskets pull out of the cabinet for full access of your cabinet.

WALL STORAGE SOLUTIONS

Maximize cabinet storage with Hardware Resources' wall cabinet solutions. From cabinet pullouts and bakeware organizers to spice racks and wine accessories, we can help you make the most beautiful and organized kitchen.



SR30 & WR36MP
Pages 407-408

Bottle Lattice and Stemware Rack

Showcase your wine collection with a beautiful wine bottle wooden lattice rack and coordinating stemware rack.



WPO2-268SC
Page 402

"No Wiggle" Wall Cabinet Pullouts

Pullout shelves keep everything within your reach.

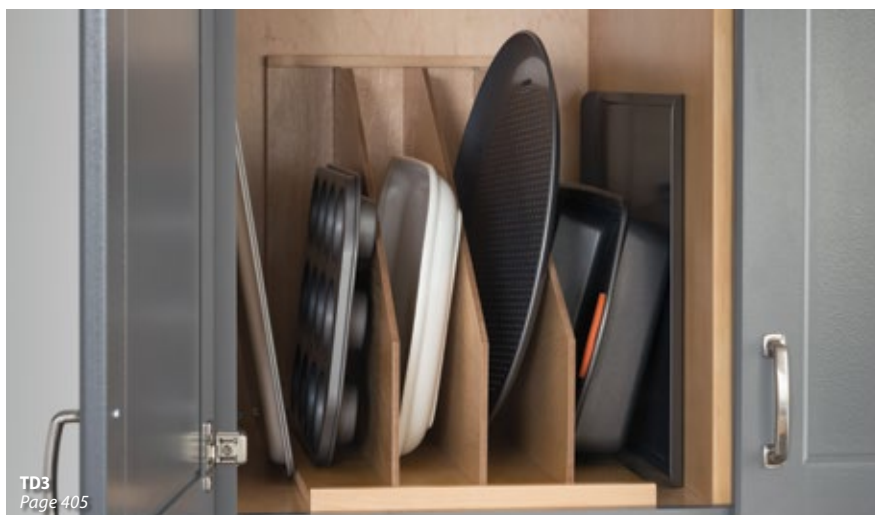

TD3
Page 405

Wooden Tray Divider

Stores pans, platters, trays, and baking sheets.



SPR9A
Page 406

Door Mount Spice Racks

Maximize your space by adding storage on your cabinet door, freeing up shelf space.

Easy-Install Kitchen Organizers are

After cabinets have been ordered and even after cabinets have been installed, your customer may want to add additional Organizers to their new cabinets. These professional-grade Organizers are designed to fit standard 1-1/2" face frame cabinets and are easy to install after the cabinets have been made.



**Bottom Mount
Trash Can Pullouts**
Install quickly with
just a few screws
See pages 318-321



Under-Sink Silicone Mat
Protects sink base
cabinets from water
damage
See page 347



Tray Dividers
Keep trays and bakeware
in easy reach
See pages 404-405



Drawer Inserts
Organize plates, bowls,
pots, lids, knives, cutlery,
spices, and coffee pods
See pages 388-397



**Shelf-Mounted
Rollout Drawers**
Bring back-of-cabinet
storage to your fingertips
See page 346



Lazy Susans
Economical and easy-to-
clean plastic trays rotate
360 degrees in either
base or wall cabinets
See pages 358-371

ideal for after cabinets are in place



Look for this logo throughout our Organizer selection for items that are easy to install after the cabinets are in place.



Wall Cabinet Pullouts

Organize wall cabinets for foodstuffs and kitchen gadgets

See pages 402-403



Door Mounted Spice Racks

2 styles available. Reclaim the cabinet door for storage

See page 406

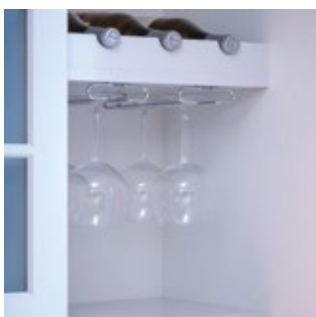

Wire Stemware Rack

Install this rack under wall cabinets with just 2 screws

See page 407



Tipout Trays

No more false drawers in front of sinks

See pages 398-399

ALSO AVAILABLE:

See our full line of 11 Minute Organizers, an easy-to-install and economical option, on pages 420-431

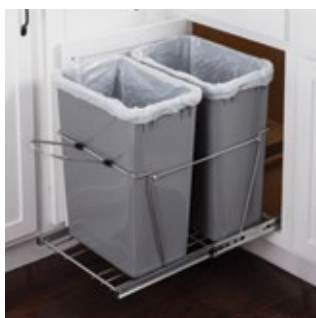

Wire Bottom Mount Trash Can Pullout

Economic and simple design makes installation easy

See page 422



Pullout Pot & Lid Organizers

Store cookware within reach, easily installs with just 4 screws

See page 425

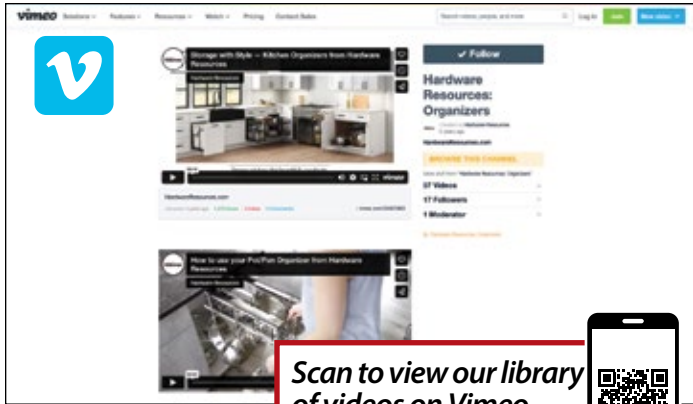

Scan to view our library of videos on Vimeo
<https://delivr.com/2hezp>

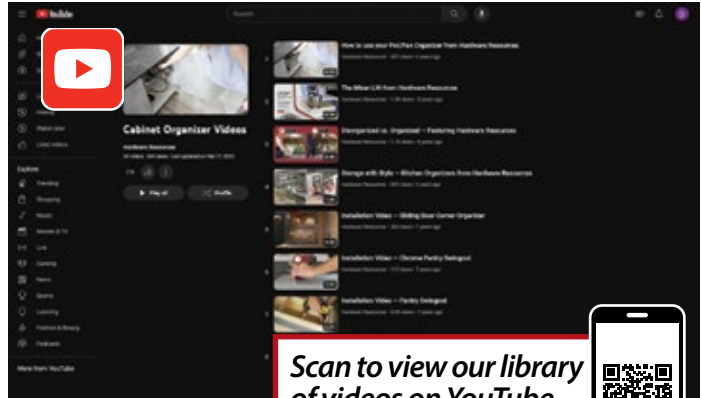

Scan to view our library of videos on YouTube
<https://delivr.com/2htr4>



Installation Videos

Installation videos for many of our organizers can be found on our website and also on our Vimeo channel.



Look for this symbol throughout our catalog to jump to the video

Scan to watch the installation video
<http://delivr.com/2knjc>



Marketing & Overview Videos

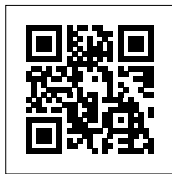

NEW Bottle & Cookware Rollouts Overview Video (ROBTD, ROCWS, ROCWD)
delivr.com/2knjc

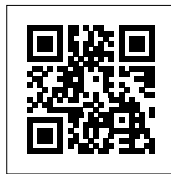

"No Wiggle" Knife Base Pullout (KBPO) Overview Video
vimeo.com/445467837

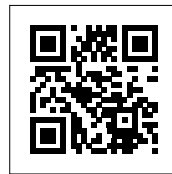

"No Wiggle" Pullout (BPO2) Comparison Video
vimeo.com/179339278

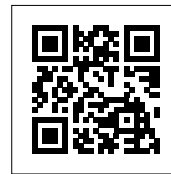

Organizers Benefits Video
vimeo.com/139974007

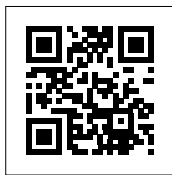

Organizers Overview
vimeo.com/154315251

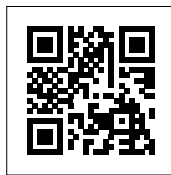

Powered Vanity Drawer (PVG) Overview Video
vimeo.com/573145505

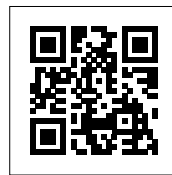

Rollouts and Highbacks Product Overview Video
vimeo.com/124835512

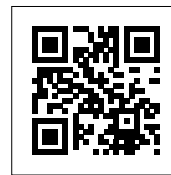

Some things shouldn't wiggle (BPO2)
vimeo.com/181622344

Installation Videos

Video Resources

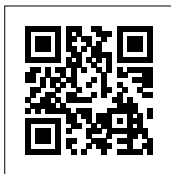

Appliance/Mixer Lift (ML-1) Installation Video
vimeo.com/224538954

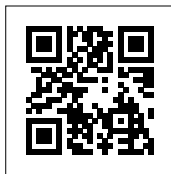

NEW Bottle & Cookware Rollouts Installation Video (ROBTD, ROCWS, ROCWD)
delivr.com/2s2y4

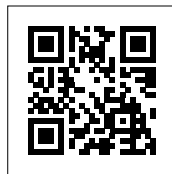

Blind Corner Swingout (BCSO) Installation Video
vimeo.com/217732515



Blind Corner Pullout (CS-SHM) Installation Video
vimeo.com/138979481



Chrome Pantry Pullout (CPPO) Installation Video
vimeo.com/138979659



Chrome Pantry Swingout (CPSO) Installation Video
vimeo.com/138979839

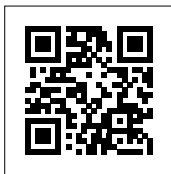

Double Cutlery Drawer (CD) (KNCD) Installation Video
vimeo.com/138980141

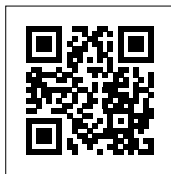

Easy Susan (CS-ES360) Installation Video
vimeo.com/138980424

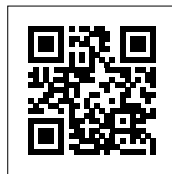

Economy Banded Lazy Susan Kit (BLSR2) Installation Video
vimeo.com/107958473

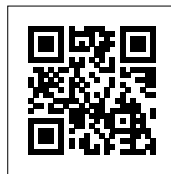

Economy Soft-Close Trash Can Pullout (WC-EMBM) Installation Video
vimeo.com/459137680

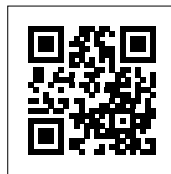

Half-Moon Lazy Susan (HMLS) Installation Video
vimeo.com/238951023

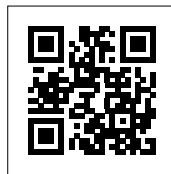

Kidney Lazy Susan Kit with Twist & Lock Pole (LSK2) Installation Video
vimeo.com/198413723

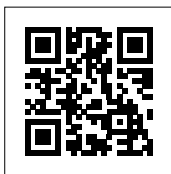

'No Wiggle' Knife Base Pullout (KBPO) Installation Video
vimeo.com/430347835



'No Wiggle' Pullout (BPO2) Installation + Tips Video
vimeo.com/180934686



Pie-Cut Lazy Susan (PLSP) Installation Video
vimeo.com/246822235



Plastic Lazy Susan with Chrome Hubs and Twist & Lock Pole (PLSM) Installation Video
vimeo.com/198411317



Powered Vanity Drawer (PVG D) Installation Video
vimeo.com/566654047



Round Lazy Susan Kit with Twist & Lock Pole (LSR2) Installation Video
vimeo.com/198414071

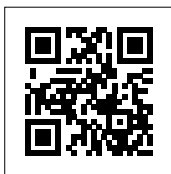

Round Plastic Lazy Susan with Twist & Lock Pole (PLS) Installation Video
vimeo.com/166805283

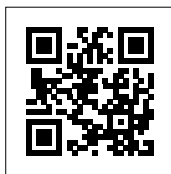

Single Shelf Lazy Susan (LSK-S) Installation Video
vimeo.com/198413388



Sliding Door Corner Organizer (CS-SDCO) Installation Video
vimeo.com/138977318



SWS Baskets Installation Video
vimeo.com/294441085



SWS Blind Corner Organizer Installation Video
vimeo.com/473706302



SWS Pot/Lid Installation Video
vimeo.com/248331955

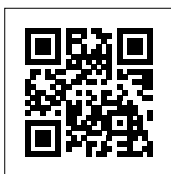

SWS Trash Can Installation Video
vimeo.com/248331963



Top Mount Trash Can System (CAN-TM) Installation Video
vimeo.com/138980671



Wood Bottom-Mount Trash Can (CAN-WBM) Installation Video
vimeo.com/198411837



Wood Bottom-Mount Trash Can with Door Brackets (CDM-WBM) Installation Video
vimeo.com/198413216



Wood Pantry Pullout (PPO2) Installation Video
vimeo.com/198408615



Wood Pantry Swingout & Door Mount (PSO & PDM) Installation Video
vimeo.com/138980578

WASTE CONTAINER ORGANIZATION



Storage with Style® Trash Can Pullout
Page 323



NEW SIZES
Premium Wood Bottom-Mount with Door Kit
Pages 318-319



Metal Drawer Box Trash Can Pullout
Page 322

Waste Container Organization

Neatly tuck away trash cans with a Hardware Resources waste container solution. From top- or bottom-mount options to premium wood or economy wire, we have a solution that will enhance your design and fit any budget.



**Wood Top Mount with
Soft-Close**
Pages 324-325



NEW SIZES
Premium Wood Bottom-Mount
Page 321



Wire Bottom-Mount
Page 327

Wood Bottom-Mount Soft-Close Trash Can Pullout with Door Kit



No kitchen is complete without a trash can pullout. Keep cans out of sight with our most popular organizer that features a mounted door for easy access.



- Features patented 6-way adjustable door-mounting brackets for easy door installation (pictured)
- Designed for cabinets with minimum opening widths 12"-21"
- Ships fully assembled and quickly mounts to the cabinet floor using four screws (included)
- Includes heavy-duty plastic trash can(s) in 35 qt. or 50 qt. and in Black, White, or Grey finishes (50 qt. cans require full-height cabinet)
- 12" single can units include a chrome-plated wire basket storage area for trash bags
- 21" double can units include a wooden storage area for trash bags
- Features 100 lb. full-extension, soft-close concealed undermount slides (preinstalled)
- UV-coated and edgebanded birch plywood construction
- Compatible with NorthPoint Cabinetry® and all other cabinetry meeting the minimum opening listed in the chart
- Includes double-sided adhesive tape to hold the door for alignment during installation



PATENTS
9,661,924
& 10,028,581



Scan to watch the installation video
<http://delivr.com/2rstv>



Wood Bottom-Mount Soft-Close Trash Can Pullout with Door Kit



CDM-WBMD3521B



CDM-WBMD3521WH



CDM-WBMD3521G

	Description	Can Color	Width	Depth	Height	Min. Opening	Standard Cab. Size	Weight Capacity	Ctn Qty
CDM-WBMS35B	Single 35 qt.	Black	12"	21-3/8"	19-3/4"	11-1/2"	15" base	100 lb.	1
CDM-WBMS35WH	Single 35 qt.	White	12"	21-3/8"	19-3/4"	11-1/2"	15" base	100 lb.	1
CDM-WBMS35G	Single 35 qt.	Grey	12"	21-3/8"	19-3/4"	11-1/2"	15" base	100 lb.	1
CDM-WBMS50B	Single 50 qt.	Black	12"	21-3/8"	24"	11-1/2"	15" full-height base	100 lb.	1
CDM-WBMS50WH	Single 50 qt.	White	12"	21-3/8"	24"	11-1/2"	15" full-height base	100 lb.	1
CDM-WBMS50G	Single 50 qt.	Grey	12"	21-3/8"	24"	11-1/2"	15" full-height base	100 lb.	1
CDM-WBMD35B	Double 35 qt.	Black	15"	21-3/8"	19-3/4"	14-1/2"	18" base	100 lb.	1
CDM-WBMD35WH	Double 35 qt.	White	15"	21-3/8"	19-3/4"	14-1/2"	18" base	100 lb.	1
CDM-WBMD35G	Double 35 qt.	Grey	15"	21-3/8"	19-3/4"	14-1/2"	18" base	100 lb.	1
CDM-WBMD50B	Double 50 qt.	Black	15"	21-3/8"	24"	15"	18" full-height base	100 lb.	1
CDM-WBMD50WH	Double 50 qt.	White	15"	21-3/8"	24"	15"	18" full-height base	100 lb.	1
CDM-WBMD50G	Double 50 qt.	Grey	15"	21-3/8"	24"	15"	18" full-height base	100 lb.	1
CDM-WBMD3518B	Double 35 qt.	Black	18"	21-3/8"	19-3/4"	18"	21" base	100 lb.	1
CDM-WBMD3518WH	Double 35 qt.	White	18"	21-3/8"	19-3/4"	18"	21" base	100 lb.	1
CDM-WBMD3518G	Double 35 qt.	Grey	18"	21-3/8"	19-3/4"	18"	21" base	100 lb.	1
CDM-WBMD5018B	Double 50 qt.	Black	18"	21-3/8"	24"	18"	21" full-height base	100 lb.	1
CDM-WBMD5018WH	Double 50 qt.	White	18"	21-3/8"	24"	18"	21" full-height base	100 lb.	1
CDM-WBMD5018G	Double 50 qt.	Grey	18"	21-3/8"	24"	18"	21" full-height base	100 lb.	1
CDM-WBMD3521B	NEW Double 35 qt.	Black	18-3/8"	21-3/8"	19-13/16"	21"	24" base	100 lb.	1
CDM-WBMD3521WH	NEW Double 35 qt.	White	18-3/8"	21-3/8"	19-13/16"	21"	24" base	100 lb.	1
CDM-WBMD3521G	NEW Double 35 qt.	Grey	18-3/8"	21-3/8"	19-13/16"	21"	24" base	100 lb.	1

Included screws: 4 #8 X1 Coarse-Thread Wood Screws (for Cabinet), 4 #6 X 1/2" Coarse-Thread Screws (for Door)

What makes a great trash can pullout?



Cans available in 2 sizes and 3 colors

Double sided foam tape for simple door mounting

Dovetail joints

Concealed, soft-close slides included (preinstalled)

UV-Coated White Birch material

Ships fully assembled and quickly mounts to cabinet floor with 4 screws (included)

Integrated 6-way adjustable door mounting brackets (CDM-WBM only)



CDM-WBM with mounted door kit

Scan QR to watch the installation video



<http://delivr.com/2RSTV>

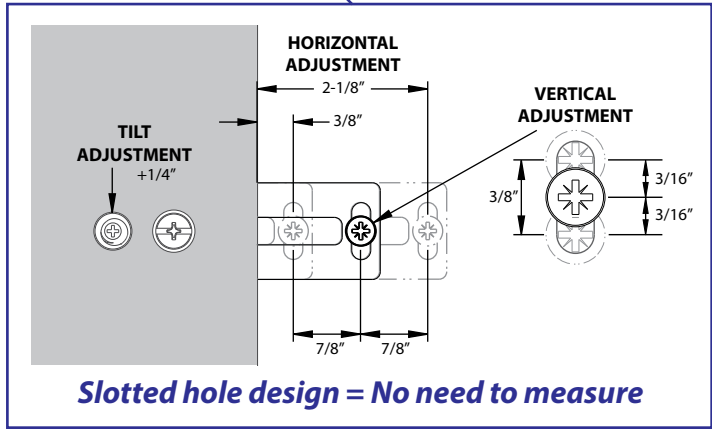

CAN-WBM for hinged door cabinets

Scan QR to watch the installation video



<http://delivr.com/2V2YC>





Wood Bottom-mount Soft-Close Trash Can Pullout for Hinged Doors

Cabinet Organizers

Complete your kitchen project with our most popular trash can pullout for hinged door application



- Designed for cabinets with 12" (single can), 15" (double can), or 18" (double can) minimum opening widths
- Ships fully assembled and quickly mounts to the cabinet floor using four screws (included)
- Includes heavy-duty plastic trash can(s) in 35 qt. or 50 qt. and in Black, White, or Grey finishes (50 qt. cans require full-height cabinet)
- 12" single can units include a chrome-plated wire basket for storage of trash bags
- Features 100 lb. full-extension, soft-close concealed undermount slides (preinstalled)
- UV-coated and edgebanded birch plywood construction
- Compatible with NorthPoint Cabinetry® and all other cabinetry meeting the minimum opening listed below



	Description	Can Color	Width	Depth	Height	Min. Opening	Standard Cab. Size	Weight Capacity	Ctn Qty
CAN-WBMS35B	Single 35 qt.	Black	12"	21-3/8"	19-3/4"	11-1/2"	15" base	100 lb.	1
CAN-WBMS35WH	Single 35 qt.	White	12"	21-3/8"	19-3/4"	11-1/2"	15" base	100 lb.	1
CAN-WBMS35G	Single 35 qt.	Grey	12"	21-3/8"	19-3/4"	11-1/2"	15" base	100 lb.	1
CAN-WBMS50B	Single 50 qt.	Black	12"	21-3/8"	24"	11-1/2"	15" full-height base	100 lb.	1
CAN-WBMS50WH	Single 50 qt.	White	12"	21-3/8"	24"	11-1/2"	15" full-height base	100 lb.	1
CAN-WBMS50G	Single 50 qt.	Grey	12"	21-3/8"	24"	11-1/2"	15" full-height base	100 lb.	1
CAN-WBMD35B	Double 35 qt.	Black	15"	21-3/8"	19-3/4"	14-1/2"	18" base	100 lb.	1
CAN-WBMD35WH	Double 35 qt.	White	15"	21-3/8"	19-3/4"	14-1/2"	18" base	100 lb.	1
CAN-WBMD35G	Double 35 qt.	Grey	15"	21-3/8"	19-3/4"	14-1/2"	18" base	100 lb.	1
CAN-WBMD50B	Double 50 qt.	Black	15"	21-3/8"	24"	15"	18" full-height base	100 lb.	1
CAN-WBMD50WH	Double 50 qt.	White	15"	21-3/8"	24"	15"	18" full-height base	100 lb.	1
CAN-WBMD50G	Double 50 qt.	Grey	15"	21-3/8"	24"	15"	18" full-height base	100 lb.	1
CAN-WBMD3518B	Double 35 qt.	Black	18"	21-3/8"	19-3/4"	18"	21" base	100 lb.	1
CAN-WBMD3518WH	Double 35 qt.	White	18"	21-3/8"	19-3/4"	18"	21" base	100 lb.	1
CAN-WBMD3518G	Double 35 qt.	Grey	18"	21-3/8"	19-3/4"	18"	21" base	100 lb.	1
CAN-WBMD5018B	Double 50 qt.	Black	18"	21-3/8"	24"	18"	21" full-height base	100 lb.	1
CAN-WBMD5018WH	Double 50 qt.	White	18"	21-3/8"	24"	18"	21" full-height base	100 lb.	1
CAN-WBMD5018G	Double 50 qt.	Grey	18"	21-3/8"	24"	18"	21" full-height base	100 lb.	1

Included screws: 4 #8 X1 Coarse-Thread Wood Screws

Waste Container Organization: Metal Drawer Box Trash Can Pullout

Add a modern touch with this stylish metal trash can pullout featuring door-mounted application for easy access



SHIPS FULLY ASSEMBLED



Designed to fit standard 1-1/2" face frame openings

Narrow 7" height double-wall metal drawer box maximizes cabinet space allowing for a single can pullout to fit in a 12" cabinet opening and the double can units to fit in a 15" cabinet opening

Ships fully assembled and quickly mounts to the cabinet floor using four screws (included)

Includes heavy-duty plastic trash can(s) in 35 qt. or 50 qt. and in Grey finish (50 qt. cans require full-height cabinet)

Integrated door brackets with vertical and horizontal adjustment

Smooth soft-close synchronized slides with 100 lb. capacity

Compatible with NorthPoint Cabinetry® and all other cabinetry meeting the minimum opening listed below



Scan to watch the installation video

<https://delivr.com/2hmwh>

	Description	Can Color	Width	Depth	Height	Min. Opening	Standard Cab. Size	Weight Capacity	Ctn Qty
CAN-MDB5-S35G	Single 35 qt.	Grey	12"	21"	20"	12"	15" base	100 lb.	1
CAN-MDB5-D35G	Double 35 qt.	Grey	15"	21"	20"	15"	18" base	100 lb.	1
CAN-MDB5-D50G	Double 50 qt.	Grey	15"	21"	24"	15"	18" full-height base	100 lb.	1

Screws included

Waste Container Organization: Storage with Style Trash Can Pullout

Add a designer's touch with flat-wire design and two stylish finishes

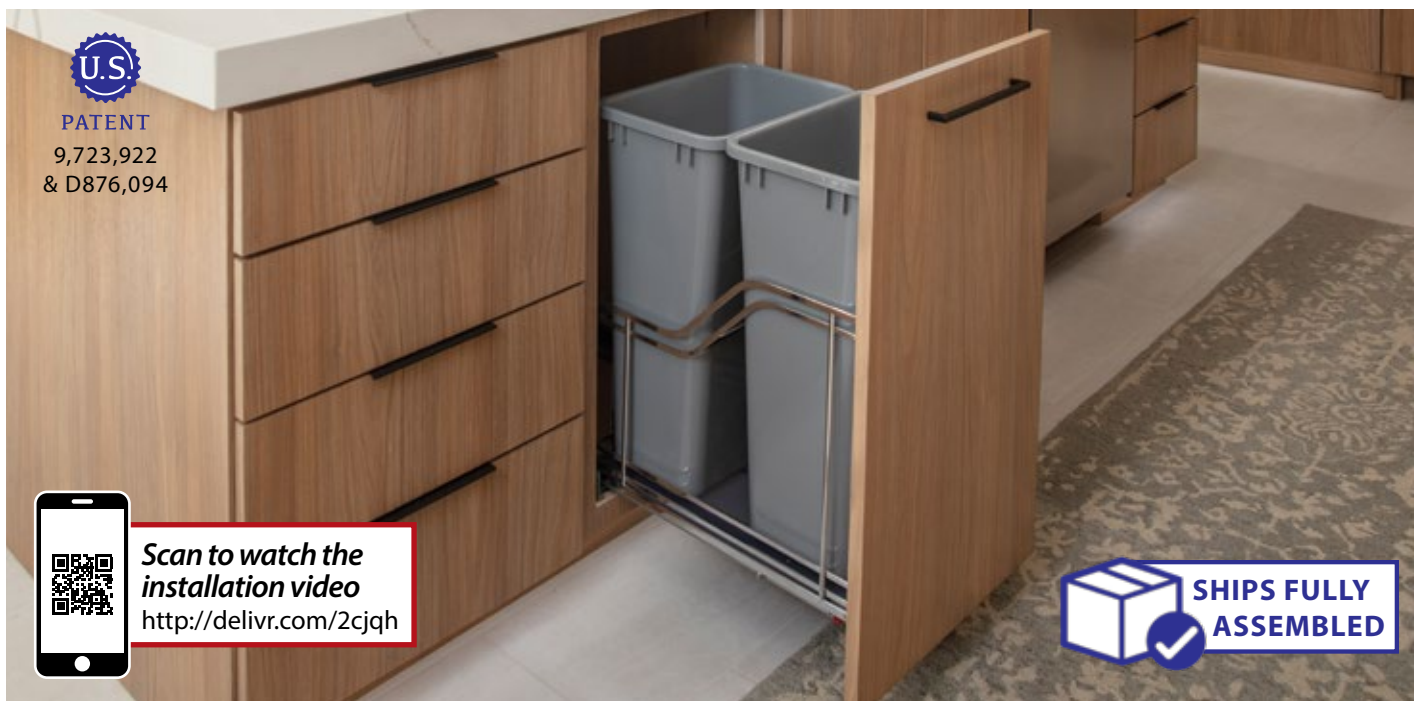

- Ships fully assembled and quickly mounts to the cabinet floor using four screws (included)
- Integrated, patented 6-way adjustable door mounting brackets
- Includes heavy-duty plastic trash can(s) in 35 qt. or 50 qt. and in Grey finish (50 qt. cans require full-height cabinet)
- Features 100 lb. full-extension, soft-close concealed undermount slides (preinstalled)
- Removable grey acrylic liners for easy cleaning
- Compatible with NorthPoint Cabinetry® and all other cabinetry meeting the minimum opening listed below

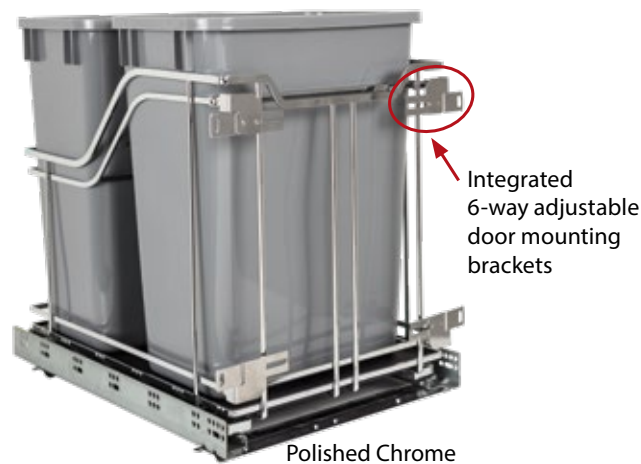

	Description	Frame Color	Can Color	Width	Depth	Height	Min. Opening	Standard Cab. Size	Weight Capacity	Ctn Qty
SWS-MBMS35GBN	Single 35 qt.	Black Nickel	Grey	12"	21-13/16"	20"	12"	15" base	100 lb.	1
SWS-MBMS35GPC	Single 35 qt.	Polished Chrome	Grey	12"	21-13/16"	20"	12"	15" base	100 lb.	1
SWS-MBMD35GBN	Double 35 qt.	Black Nickel	Grey	14-15/16"	21-13/16"	20"	15"	18" base	100 lb.	1
SWS-MBMD35GPC	Double 35 qt.	Polished Chrome	Grey	14-15/16"	21-13/16"	20"	15"	18" base	100 lb.	1
SWS-MBMD50GBN	Double 50 qt.	Black Nickel	Grey	14-15/16"	21-13/16"	24"	15"	18" full-height base	100 lb.	1
SWS-MBMD50GPC	Double 50 qt.	Polished Chrome	Grey	14-15/16"	21-13/16"	24"	15"	18" full-height base	100 lb.	1

Screws included

Waste Container Organization: Wood Top Mount with Soft-Close

The beauty of a wood pullout at an economical price



- Features 100 lb. soft-close ball bearing slides (preinstalled)
 - Self-adjusting back brackets included for face-frame application
 - Included trash can ring allows for use with either a 35 qt. or 50 qt. can (50 qt. cans require full-height cabinet)
 - Door mounting bracket included with horizontal and vertical adjustments
 - Single can units come with a stainless steel basket to hold trash bags
 - Solid white birch construction with clear UV finish
 - Compatible with NorthPoint Cabinetry® and all other cabinetry meeting the minimum opening listed below
- Cans sold separately (see page 328)**



Cans Sold Separately
See page 328

US patents for 6-way adjustable door brackets on CAN-TMDSC-15: 9,661,924 and 10,028,581

	Description	Width	Depth	Height*	Min. Opening	Standard Cab. Size	Weight Capacity	Ctn Qty
CAN-TMSC-12	Single 35 qt. or 50 qt.**	12"	21-5/8"	3-1/4"	12"	15" base	100 lb.	1
CAN-TMSC-15	Single 35 qt. or 50 qt.**	15"	21-5/8"	3-1/4"	15"	18" base	100 lb.	1
CAN-TMDSC-15*	Double 35 qt.	15"	21-3/4"	8-9/16"	15"	18" base	90 lb.	1
CAN-TMDSC-18	Double 35 qt. or 50 qt.**	18"	21-5/8"	3-1/4"	18"	21" base	90 lb.	1
CAN-TMDSC-21	Double 35 qt. or 50 qt.**	21"	21-5/8"	3-1/4"	21"	24" base	90 lb.	1

Recommended screw:

#8 flat head

Height does not include cans. Height with can is same as can height. See page 328 for cans.
*Trash can ring not included for CAN-TMDSC-15. ** Full-height base

Waste Container Organization: Wood Top Mount with Soft-Close & Cans



Order with cans included!

Comes in all finishes and sizes, just order one part number to get all components needed.

SKU	Description	Width	Depth	Height	Min. Opening	Standard Cab. Size	Weight Capacity	Ctn Qty
CAN-TMS1235B-K	Single 35 qt. - Black can	12"	21-5/8"	18"	12"	15" base	100 lb.	1
CAN-TMS1235G-K	Single 35 qt. - Grey can	12"	21-5/8"	18"	12"	15" base	100 lb.	1
CAN-TMS1235W-K	Single 35 qt. - White can	12"	21-5/8"	18"	12"	15" base	100 lb.	1
CAN-TMS1250B-K	Single 50 qt. - Black can	12"	21-5/8"	22-1/4"	12"	15" full-height base	100 lb.	1
CAN-TMS1250G-K	Single 50 qt. - Grey can	12"	21-5/8"	22-1/4"	12"	15" full-height base	100 lb.	1
CAN-TMS1250W-K	Single 50 qt. - White can	12"	21-5/8"	22-1/4"	12"	15" full-height base	100 lb.	1
CAN-TMD1535B-K	Double 35 qt. - Black cans	15"	21-3/4"	18"	15"	18" base	100 lb.	1
CAN-TMD1535G-K	Double 35 qt. - Grey cans	15"	21-3/4"	18"	15"	18" base	100 lb.	1
CAN-TMD1535W-K	Double 35 qt. - White cans	15"	21-3/4"	18"	15"	18" base	100 lb.	1
CAN-TMS1535B-K	Single 35 qt. - Black can	15"	21-5/8"	18"	15"	18" base	100 lb.	1
CAN-TMS1535G-K	Single 35 qt. - Grey can	15"	21-5/8"	18"	15"	18" base	100 lb.	1
CAN-TMS1535W-K	Single 35 qt. - White can	15"	21-5/8"	18"	15"	18" base	100 lb.	1
CAN-TMS1550B-K	Single 50 qt. - Black can	15"	21-5/8"	22-1/4"	15"	18" full-height base	100 lb.	1
CAN-TMS1550G-K	Single 50 qt. - Grey can	15"	21-5/8"	22-1/4"	15"	18" full-height base	100 lb.	1
CAN-TMS1550W-K	Single 50 qt. - White can	15"	21-5/8"	22-1/4"	15"	18" full-height base	100 lb.	1
CAN-TMD1835B-K	Double 35 qt. - Black cans	18"	21-5/8"	18"	18"	21" base	100 lb.	1
CAN-TMD1835G-K	Double 35 qt. - Grey cans	18"	21-5/8"	18"	18"	21" base	100 lb.	1
CAN-TMD1835W-K	Double 35 qt. - White cans	18"	21-5/8"	18"	18"	21" base	100 lb.	1
CAN-TMD1850B-K	Double 50 qt. - Black cans	18"	21-5/8"	22-1/4"	18"	21" full-height base	100 lb.	1
CAN-TMD1850G-K	Double 50 qt. - Grey cans	18"	21-5/8"	22-1/4"	18"	21" full-height base	100 lb.	1
CAN-TMD1850W-K	Double 50 qt. - White cans	18"	21-5/8"	22-1/4"	18"	21" full-height base	100 lb.	1
CAN-TMD2135B-K	Double 35 qt. - Black cans	21"	21-5/8"	18"	21"	24" base	100 lb.	1
CAN-TMD2135G-K	Double 35 qt. - Grey cans	21"	21-5/8"	18"	21"	24" base	100 lb.	1
CAN-TMD2135W-K	Double 35 qt. - White cans	21"	21-5/8"	18"	21"	24" base	100 lb.	1
CAN-TMD2150B-K	Double 50 qt. - Black cans	21"	21-5/8"	22-1/4"	21"	24" full-height base	100 lb.	1
CAN-TMD2150G-K	Double 50 qt. - Grey cans	21"	21-5/8"	22-1/4"	21"	24" full-height base	100 lb.	1
CAN-TMD2150W-K	Double 50 qt. - White cans	21"	21-5/8"	22-1/4"	21"	24" full-height base	100 lb.	1

Recommended screw:

#8 flat head

Waste Container Organization: Economy Soft-Close Trash Can Pullout

Impress your budget-minded clients with a trash can pullout that's priced for any kitchen without compromising on features or quality



35 qt. configurations fit in under-drawer base cabinets



50 qt. configurations fit in full-height base cabinets

Designed for cabinets with 12" (single can) or 15" (double can) minimum opening width
 Features patented 6-way adjustable door mounting brackets for ease of door installation
 Includes heavy-duty plastic trash can(s) in 35 qt. or 50 qt. and in Grey finish (50 qt. cans require full-height cabinet)
 Features 100 lb. full-extension, soft-close, concealed undermount slides (preinstalled)
 Ships fully assembled and quickly mounts to the cabinet floor using four screws (included)
 Compatible with NorthPoint Cabinetry® and all other cabinetry meeting the minimum opening listed below



9,661,924
& 10,028,581

PATENT

Item Number	Description	Width	Depth	Height	Min Opening Width	Standard Cabinet Size	Weight Capacity	Ctn Qty
WC-EMBM-S35G	Single 35 qt. - Grey can	11-1/2"	21-13/16"	20-5/8"	11-1/2"	15" base	100 lb.	1
WC-EMBM-S50G	Single 50 qt. - Grey can	11-1/2"	21-13/16"	24-13/16"	11-1/2"	15" full-height base	100 lb.	1
WC-EMBM-D35G	Double 35 qt. - Grey cans	14-1/4"	21-13/16"	20-5/8"	14-1/2"	18" base	100 lb.	1
WC-EMBM-D50G	Double 50 qt. - Grey cans	14-5/8"	21-13/16"	24-13/16"	15"	18" full-height base	100 lb.	1

Screws included

Waste Container Organization: Wire Bottom Mount

A simple, no frills trash can pullout for budget-conscious customers



Cans Sold Separately
See page 328

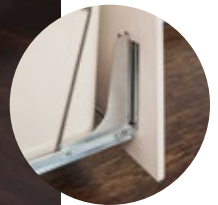

! Use optional door mounting kit for door pullout application

- Heavy-duty 100 lb. full-extension ball bearing slides
- Thick wire frame construction
- Cans and lids sold separately (see page 328)
- Quickly mounts to cabinet floor using four screws (included)
- Removable wire handle included

- Optional 6-way adjustable door mounting kit for door pullout application
- Compatible with NorthPoint Cabinetry® and all other cabinetry meeting the minimum opening listed below

Note: Double 50 qt. can unit requires full-height cabinet



	Description	Finish	Width	Depth	Height	Min. Opening	Standard Cabinet Size	Weight Capacity	Ctn Qty
CAN-EBMSB-R	Single Can Unit - 35 or 50 qt.	Black	10-1/4"	22-1/16"	13"	11-1/2"	15" base	50 lb.	6
CAN-EBMSPC-R	Single Can Unit - 35 or 50 qt.	Polished Chrome	10-1/4"	22-1/16"	13"	11-1/2"	15" base	50 lb.	6
CAN-EBMSW-R	Single Can Unit - 35 or 50 qt.	White	10-1/4"	22-1/16"	13"	11-1/2"	15" base	50 lb.	6
CAN-EBMDB-R	Double Can Unit - 35 qt. only	Black	13-15/16"	22"	13"	14-1/2"	18" base	50 lb.	4
CAN-EBMDPC-R	Double Can Unit - 35 qt. only	Polished Chrome	13-15/16"	22"	13"	14-1/2"	18" base	50 lb.	4
CAN-EBMDW-R	Double Can Unit - 35 qt. only	White	13-15/16"	22"	13"	14-1/2"	18" base	50 lb.	4
CAN-EBMD50B-R	Double Can Unit - 50 qt. only	Black	15-3/16"	22-1/16"	12-13/16"	15-3/16"	18" full-height base	50 lb.	4
CAN-EBMD50PC-R	Double Can Unit - 50 qt. only	Polished Chrome	15-3/16"	22-1/16"	12-13/16"	15-3/16"	18" full-height base	50 lb.	4
CAN-EBMD50W-R	Double Can Unit - 50 qt. only	White	15-3/16"	22-1/16"	12-13/16"	15-3/16"	18" full-height base	50 lb.	4
CAN-DOORKIT	Door Mounting Kit	Black	2-1/2"	5-1/4"	6-5/8"	-	-	-	20
CAN-DOORKITPC	Door Mounting Kit	Polished Chrome	2-1/2"	5-1/4"	6-5/8"	-	-	-	20
CAN-DOORKITW	Door Mounting Kit	White	2-1/2"	5-1/4"	6-5/8"	-	-	-	20

Screws included

Waste Container Organization: Cans & Lids



Cans available in 2 sizes and 3 standard colors – black, grey, & white
 Lids available in 3 standard colors plus green for recycling
 High quality polymer plastic material is durable and easy to clean
 Compatible with all of our trash can pullouts

	Description	Can Color	Width	Depth	Height	Ctn Qty
CAN-35	35 qt. Plastic Can	Black	14-1/4"	9-7/16"	18"	10
CAN-35W	35 qt. Plastic Can	White	14-1/4"	9-7/16"	18"	10
CAN-35GRY	35 qt. Plastic Can	Grey	14-1/4"	9-7/16"	18"	10
CAN-35LID	Lid for 35 qt. Plastic Can	Black	14-1/4"	9-3/8"	1-5/8"	10
CAN-35LIDW	Lid for 35 qt. Plastic Can	White	14-1/4"	9-3/8"	1-5/8"	10
CAN-35LIDGRY	Lid for 35 qt. Plastic Can	Grey	14-1/4"	9-3/8"	1-5/8"	10
CAN-35LIDG	Lid for 35 qt. Plastic Can	Green	14-1/4"	9-3/8"	1-5/8"	10
CAN-50	50 qt. Plastic Can	Black	14-7/8"	10-1/4"	22-1/4"	10
CAN-50W	50 qt. Plastic Can	White	14-7/8"	10-1/4"	22-1/4"	10
CAN-50GRY	50 qt. Plastic Can	Grey	14-7/8"	10-1/4"	22-1/4"	10
CAN-50LID	Lid for 50 qt. Plastic Can	Black	14-5/8"	10-1/4"	1-5/8"	10
CAN-50LIDW	Lid for 50 qt. Plastic Can	White	14-5/8"	10-1/4"	1-5/8"	10
CAN-50LIDGRY	Lid for 50 qt. Plastic Can	Grey	14-5/8"	10-1/4"	1-5/8"	10
CAN-50LIDG	Lid for 50 qt. Plastic Can	Green	14-5/8"	10-1/4"	1-5/8"	10



Great for

 Recycling

Waste Container Organization: Cross Reference Guide

Waste Container Solutions

Cabinet	Wood Bottom Mount - Double Can					Wood Bottom Mount - Single Can					Wood Top Mount - Double Can					Wood Top Mount - Single Can				
	CDM-WBMD35X	CAN-WBMD35X	CDM-WBMD3518X	CAN-WBMD3518X	CAN-WBMD3521X NEW	CDM-WBMD50X	CAN-WBMD50X	CDM-WBMS35VX NEW	CDM-WBMS50X	CAN-WBMS50X	CAN-TMD1535X-K	CAN-TMD1835X-K	CAN-TMD2135X-K	CAN-TMS1235X-K	CAN-TMS1250X-K	CAN-TMS1535X-K	CAN-TMS1550X-K			
B15																				
B18	•	•									•									
B21			•	•								•								
B24					•								•							
BFH15									•	•					•	•				
BFH18	•	•				•	•				•					•	•			
VB15								•												

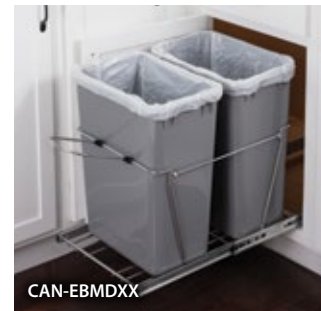

Cabinet	Wire - Double Can				Wire - Single Can			Metal - Double Can		Metal - Single Can		Storage with Style - Double Can		Storage with Style - Single Can
	CAN-EBMDXX	CAN-EBMD50XX	WC-EMBM-D35G	WC-EMBM-D50G	CAN-EBMSXX	WC-EMBM-S35G	WC-EMBM-S50G	CAN-MDB5-D35G	CAN-MDB5-D50G	CAN-MDB5-S35G	SWS-MBMD35GXX	SWS-MBMD50GXX	SWS-MBMS35GXX	
B15					•	•				•			•	
B18	•		•					•			•			
BFH15					•	•	•			•			•	
BFH18	•	•	•	•				•	•		•	•		

BASE CABINET ORGANIZATION



"No Wiggle" Base Pullout
Pages 333-334

Base Cabinet Organization

Maximize cabinet storage with our base cabinet organization. From cabinet pullouts to mixer lifts, we can help you create a beautiful and organized kitchen.

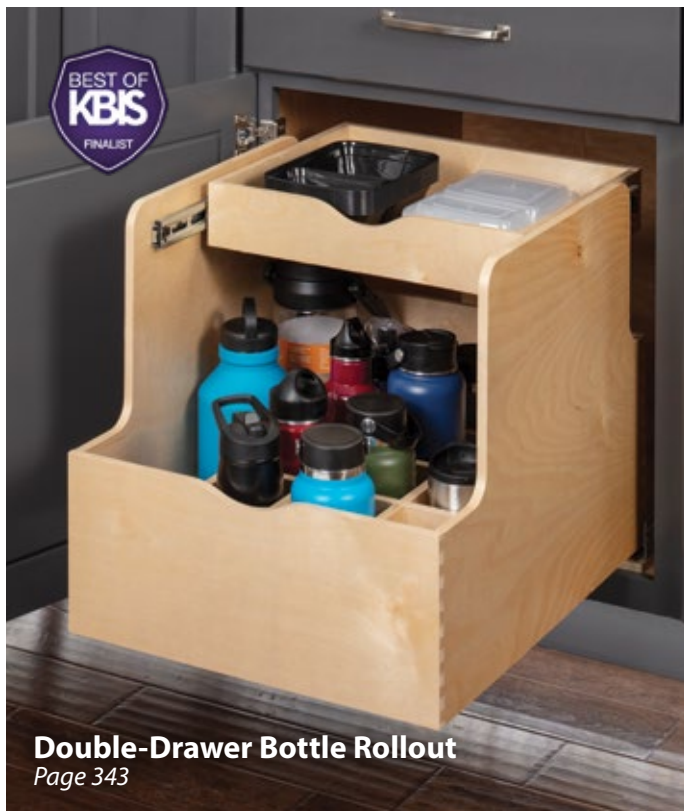

Some things should wiggle.

To see our patented "No Wiggle" technology in action, scan the QR code or visit:
<http://delivr.com/2h4vw>



Your cabinet pullout shouldn't.



Hardware Resources has designed the **sturdiest cabinet pullout** on the market



- "No Wiggle" patented hardware **eliminates excessive sag and side-to-side movement**
- **Ships fully assembled** and installs in minutes, saving time
- 6-way integrated door mounting hardware for **precise door adjustments**

Look for this icon to identify organizer products featuring our patented "No Wiggle" technology

Base Cabinet Organization: "No Wiggle" Base Pullout



Patented top mounting bracket eliminates excessive side-to-side movement and sag, yet is hidden under the first shelf for a clean look

Bottom slides are concealed undermount slides, and the top is a 225 lb. slide for added support and weight bearing (preinstalled)

Patented integrated 6-way adjustable door-mounting brackets allow for easy mounting of door

Frameless Friendly! Works in both face frame and frameless applications

Ships fully assembled making installation a breeze

Compatible with NorthPoint Cabinetry® and all other cabinetry meeting the minimum opening listed below



9,661,924 & 9,723,922
10,028,581 & 10,251,480

Requires full door cabinet

Scan to watch the installation video
<http://delivr.com/22TZY>

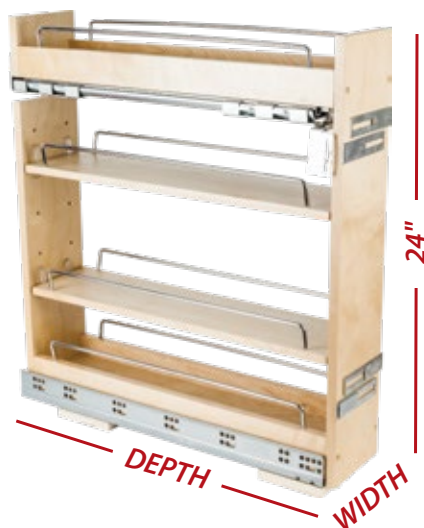

	Width	Depth	Height	Min. Opening	Standard Cabinet Size	Weight Capacity	Ctn Qty
BPO2-5SC	5-1/2"	22"	24"	5-1/2"	9" full-height base	100 lb.	1
BPO2-8SC	8-1/2"	22"	24"	8-1/2"	12" full-height base	100 lb.	1
BPO2-11SC	11-1/2"	22"	24"	11-1/2"	15" full-height base	100 lb.	1
BPO2-14SC	14-1/2"	22"	24"	14-1/2"	18" full-height base	100 lb.	1

Recommended screw: #8 flat head



Extra Rails

	Ctn Qty
RAIL-17-PC Extra rail for BPO series	50

Base Cabinet Organization: "No Wiggle" Pullouts

What makes a great pullout?

Self-indexing rear bracket

UV Coated White Birch

225 lb. slide for strength and stability

Ships fully assembled for fast installation

2 adjustable shelves

Adjustable front mounting bracket eliminates excessive wiggle

3M™ double-sided tape included for temporary door placement and alignment during installation

Concealed soft-close slides (preinstalled)

Integrated 6-way adjustable door mounting brackets

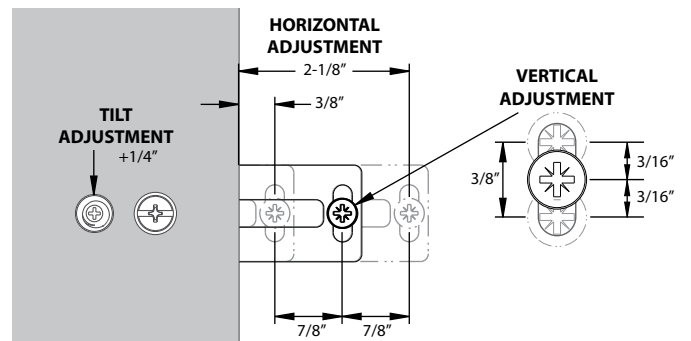

Slotted hole design = no need to measure



Patented mounting hardware
US Patents 9,661,924 & 10,028,581

Base Cabinet Organization: "No Wiggle" Knife Block Pullout

Keep knives sharp, safe, and out of sight—off the countertop

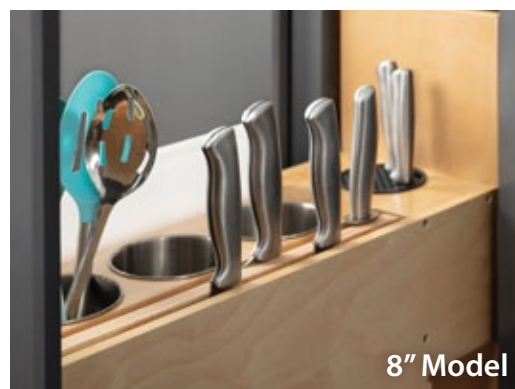

Scan to watch the installation video
<https://delivr.com/29x99>



Did you know...

- Storing knives in traditional knife blocks or plastic sheaths dulls their blades over time.
- Magnetic strips keep knives sharper by minimizing blade contact. Our Knife Pullout features a strong magnetic bar embedded in wood for ideal knife storage.
- Sharp knives are key to safe and effective cutting, and good knives are expensive. Our innovative pullout protects this investment by storing knives properly.



Plastic Cutting Board

- Included with both models
- Stows neatly in custom slot
- Dishwasher safe
- Non-skid feet

Double-sided magnetic bar with a total of 31-1/2" of knife storage (fits blades up to 9" long)
 Round insert holds a set of six steak knives
 Open bottom shelf provides additional storage
 Patented front mounting bracket eliminates excessive side-to-side movement and sag, yet is hidden for a clean look
 Bottom slides are concealed undermount slides, and the top is a 225 lb. slide for added support and weight bearing (preinstalled)
 Compatible with NorthPoint Cabinetry® and all other cabinetry meeting the minimum opening listed below



PATENTS
 9,723,922
 & 11,388,996



Stainless Steel Utensil Bins

8" model also includes 3 bins that are easy to remove for cleaning. Replacement bins: UCSS-46, see page 336

	Width	Depth	Height	Minimum Opening	Standard Cabinet Size	Weight Capacity	Ctn Qty
KBPO-5SC	5"	22"	24"	5-1/2"	9" full-height base	100 lb.	1
KBPO-8SC	8"	22"	24"	8-1/2"	12" full-height base	100 lb.	1

Screws included

Base Cabinet Organization: "No Wiggle" Utensil Pullout

Declutter countertops with convenient in-cabinet utensil storage.



SHIPS FULLY ASSEMBLED



Scan to watch the installation video
<http://delivr.com/22TZY>



- Included 4 stainless steel bins are sturdy and easy to remove for cleaning
- Open bottom shelf for additional storage
- Built on our "No Wiggle" platform
- Patented top mounting bracket eliminates excessive side-to-side movement and sag, yet is hidden under the first shelf for a clean look
- Bottom slides are concealed undermount slides, and the top is a 225 lb. slide for added support and weight bearing (preinstalled)
- Patented integrated 6-way adjustable door-mounting brackets allow for easy mounting of door
- Frameless Friendly! Works in both face frame and frameless applications
- Ships fully assembled making installation a breeze
- Compatible with NorthPoint Cabinetry® and all other cabinetry meeting the minimum opening listed below



PATENT

9,661,924 & 9,723,922
 10,028,581 & 10,251,480



Requires full door cabinet



	Width	Depth	Height	Min. Opening	Standard Cabinet Size	Weight Capacity	Ctn Qty
UBPO-5SC	5-1/2"	22"	24"	5-1/2"	9" full-height base	100 lb.	1
UBPO-8SC	8-1/2"	22"	24"	8-1/2"	12" full-height base	100 lb.	1

Screws included



Replacement Utensil Bins Ctn Qty

UCSS-45	Replacement bins for UBPO-5SC	50
UCSS-46	Replacement bins for UBPO-8SC	50

Base Cabinet Organization: "No Wiggle" Drawer Base Pullout

Narrow cabinets under drawers are fully functional with this pullout that makes the back of the cabinet accessible



Fits below a drawer!

- Shorter height fits below drawer
- Built on our "No Wiggle" platform
- Patented top mounting bracket eliminates excessive side-to-side movement and sag, yet is hidden under the first shelf for a clean look
- Bottom slides are concealed undermount slides, and the top is a 225 lb. slide for added support and weight bearing (preinstalled)
- Patented integrated 6-way adjustable door-mounting brackets allow for easy mounting of door
- One adjustable shelf included
- Frameless Friendly! Works in both face frame and frameless applications
- Ships fully assembled making installation a breeze
- Compatible with NorthPoint Cabinetry® and all other cabinetry meeting the minimum opening listed below

Scan to watch the installation video

<http://delivr.com/22TZY>



	Width	Depth	Height	Min. Opening	Standard Cabinet Size	Weight Capacity	Ctn Qty
DBPO-5SC	5-1/2"	22"	20"	5-1/2"	9" base	100 lb.	1
DBPO-8SC	8-1/2"	22"	20"	8-1/2"	12" base	100 lb.	1

Screws included



Extra Rails

RAIL-17-PC Extra rail for BPO series

Ctn Qty

50



9,661,924 & 9,723,922
10,028,581 & 10,251,480

Base Cabinet Organization: "No Wiggle" Tray Divider Pullout

Give sheet pans a home. Also great for foil, plastic wrap, and zip bag storage



Scan to watch the installation video
<http://delivr.com/22TZY>



- Built on our "No Wiggle" platform
- Patented top mounting bracket eliminates excessive side-to-side movement and sag
- Removable center rack and adjustable dividing bars allow for easy and versatile customization of storage needs
- Patented integrated 6-way adjustable door-mounting brackets allow for easy mounting of door
- Frameless Friendly! Works in both face frame and frameless applications
- Non-slip bottom mat keeps items secure and minimizes noise
- Compatible with NorthPoint Cabinetry® and all other cabinetry meeting the minimum opening listed below



9,661,924 & 9,723,922
10,028,581 & 10,251,480



Also great for foil, plastic wrap and bag storage

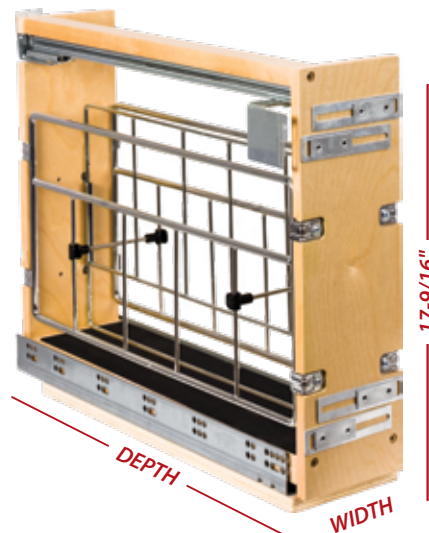

	Width	Depth	Height	Min. Opening	Standard Cabinet Size	Weight Capacity	Ctn Qty
BPOTD2-5SC	5"	22-1/4"	17-9/16"	5-1/2"	9" base	100 lb.	1
BPOTD2-8SC	8"	22-1/4"	17-9/16"	8-1/2"	12" base	100 lb.	1

Recommended screw: #8 flat head

Base Cabinet Organization: "No Wiggle" Base Filler Pullout

Reclaim dead space, so that kitchen essentials will be nearby when they're needed



- Installs in dead space between base cabinets
- Built on our "No Wiggle" platform
- Patented top mounting bracket eliminates excessive side-to-side movement and sag, yet is hidden under the first shelf for a clean look
- Patented integrated 6-way adjustable door-mounting brackets allow for easy mounting of door
- Two adjustable shelves included
- Frameless Friendly! Works in both face frame and frameless applications
- Ships fully assembled making installation a breeze



9,661,924 & 9,723,922
10,028,581 & 10,251,480



	Width	Depth	Height	Min. Opening	Weight Capacity	Ctn Qty
BFPO2-3SC	3-1/2"	23"	30"	3-1/2"	100 lb.	1
BFPO2-6SC	6-1/2"	23"	30"	6-1/2"	100 lb.	1

Recommended screw: #6 face frame



Base Cabinet Organization: Peg Board Filler Pullout

Convert wasted space into a customizable organizer solution for everything from pots and pans to big utensils with the variety of included hooks



- Features 100 lb. full-extension soft-close ball bearing slides
- Each pullout comes with an assortment of pegs and hooks (12 pegs, 12 single hooks, 6 double hooks)
- Additional hook packs sold separately (3 hooks/pack)
- Available in 2 width options
- Stainless steel pegboard is easy to clean and magnetic
- Edgeworked birch plywood construction with clear UV finish

! Can be mounted left- or right-handed



Extra Peg
BFPOSS-PEG



Extra Single Hook
BFPOSS-S3



Extra Double Hook
BFPOSS-D3



Chrome Rail
RAIL-17-PC

	Width	Depth	Height	Min. Opening	Weight Capacity	Ctn Qty
BFPOSS3	3"	23"	30"	3"	100 lb.	1
BFPOSS6	6"	23"	30"	6"	100 lb.	1

Recommended screw: #8 flat head

Extra Hardware		Ctn Qty
BFPOSS-D3	Double hooks	3 hooks/bag
BFPOSS-S3	Single hooks	3 hooks/bag
BFPOSS-PEG	Single pegs	3 pegs/bag
RAIL-17-PC	Chrome rail	50 rails

Base Cabinet Organization: Appliance Lift

Easily bring heavy appliances to working height



- Provides mechanical assistance for heavy appliances such as a mixer
- Features soft-close dampers for smooth closing
- Can be used in both frameless and face frame cabinetry
- Shelf (not included) can be custom fit to any cabinet size
- Three spring settings for up to 45 lb. capacity
- Designed for full-height door cabinets
- Compatible with NorthPoint Cabinetry® and all other cabinetry meeting the minimum opening listed below



Pair with a pullout basket (MBPO series shown) to store appliance supplies and accessories



Scan to watch the installation video
<http://delivr.com/2NR58>

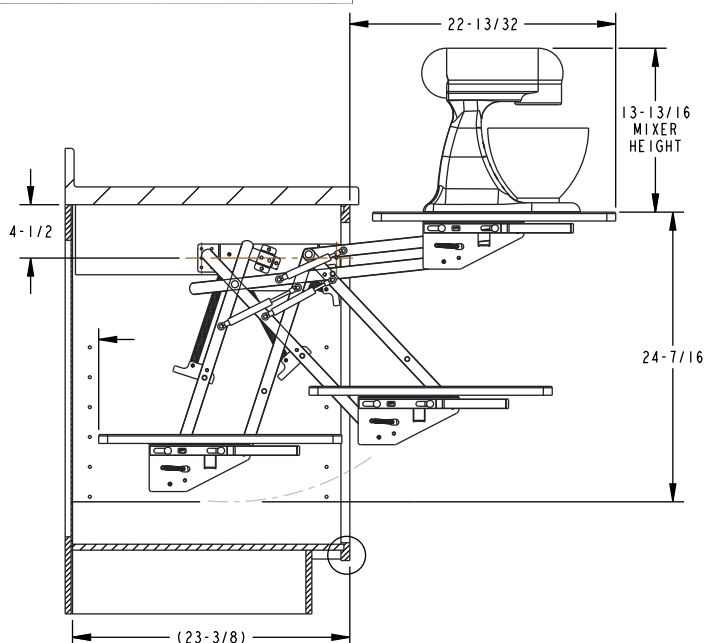

	Weight Capacity	Standard Cabinet Size	Opening	Ctn Qty
ML-1CH	45 lb.	15"-27" full-height cabinet	12" min. 24" max.	1

Recommended screw: #8 pan head screws for mounting to cabinet included

Shelf material is not included. Shelf should be a minimum of 3/4" thick and no longer than 20-1/2" long.

Shelf width is determined by measuring between the side mounting brackets minus 1-1/4". Attach shelf to mounting brackets with at least 8 suggested #8 x 1/2" wood screws (not provided).

Base Cabinet Organization: Rollout Organizers



Modern homeowners demand solutions that fit their lifestyle. These rollouts provide clever storage for a variety of items to meet consumer needs while maximizing the functionality of any kitchen space.

Create dedicated storage for sports bottles for an active family or build alcohol bottle storage for a home bar with the Bottle Rollout.

The divided drawers on the Cookware Rollouts can be configured to fit a variety of kitchen accoutrements including pans, bakeware, trays, cutting boards, and even oversize holiday serving platters.

Double-Drawer Rollouts feature a top drawer for storage of lids and smaller items that pushes back into the cabinet for full access to the bottom drawer.



Double-Drawer Bottle Rollout



See details on next page

Single-Drawer Cookware Rollout



See details on page 345

Double-Drawer Cookware Rollout



See details on page 344

Base Cabinet Organization: Double-Drawer Bottle Rollout

Organize drinkware and bottles with this grid organizer featuring top shelf for smaller item storage

15", 21", and 27" widths

Innovative bottle grid neatly stores 15 items in multiple cubby hole sizes

Bottle grid can be moved to either side of 21" and 27" units and dividers can be spaced using pin-and-groove system

Top drawer slides back for full access to items in bottom drawer

Designed for 18", 24", and 30" base cabinets with top drawer or full-height cabinets

Ships fully assembled and quickly mounts to the cabinet floor using four screws (included)

UV-coated and edgebanded white birch plywood construction

Features 100 lb. full-extension, soft-close, concealed undermount slides

Compatible with NorthPoint Cabinetry® and all other cabinetry meeting the minimum openings listed below (see page 448 for reference guide)



Scan to watch the installation video
<https://delivr.com/2s2y4>



ROBTD15-WB



ROBTD21-WB



ROBTD27-WB

	Description	# Dividers	Width	Depth	Height	Min. Opening	Standard Cab. Size	Weight Capacity	Ctn Qty
ROBTD15-WB	Double-Drawer Bottle	0	13-9/16"	22-3/8"	19-1/16"	14-1/2"	18" base	100 lb.	1
ROBTD21-WB	Double-Drawer Bottle	2	19-1/8"	22-3/8"	19-1/16"	20-1/2"	24" base	100 lb.	1
ROBTD27-WB	Double-Drawer Bottle	3	25-1/8"	22-3/8"	19-1/16"	26-1/2"	30" base	100 lb.	1

Included screws: 4 #8 X1 Coarse-Thread Wood Screws

Base Cabinet Organization: Double-Drawer Cookware Rollout

Bakeware, trays, and cutting boards are securely stored vertically in this pullout—there's even a place for lids on the top drawer!

15", 21", and 27" widths

- Top drawer slides back for full access to items in bottom drawer
- Movable dividers can be adjusted using pin-and-groove system
- Designed for 18", 24", and 30" base cabinets with top drawer or full-height cabinets
- Ships fully assembled and quickly mounts to the cabinet floor using four screws (included)
- UV-coated and edgebanded white birch plywood construction
- Features 100 lb. full-extension, soft-close, concealed undermount slides
- Compatible with NorthPoint Cabinetry® and all other cabinetry meeting the minimum openings listed below (see page 448 for reference guide)



Scan to watch the installation video
<https://delivr.com/2s2y4>



	Description	# Dividers	Width	Depth	Height	Min. Opening	Standard Cab. Size	Weight Capacity	Ctn Qty
ROCWD15-WB	Double-Drawer Cookware	5	13-9/16"	22-3/8"	19-1/16"	14-1/2"	18" base	100 lb.	1
ROCWD21-WB	Double-Drawer Cookware	7	19-1/8"	22-3/8"	19-1/16"	20-1/2"	24" base	100 lb.	1
ROCWD27-WB	Double-Drawer Cookware	9	25-1/8"	22-3/8"	19-1/16"	26-1/2"	30" base	100 lb.	1

Included screws: 4 #8 X1 Coarse-Thread Wood Screws

Base Cabinet Organization: Single-Drawer Cookware Rollout

Organize taller bakeware and trays with this single-drawer divided pullout



15", 21", and 27" widths

- This unit accommodates larger items in an easily accessible vertical position
- Movable dividers can be adjusted using pin-and-groove system
- Designed for 18", 24", and 30" base cabinets with top drawer or full-height cabinets
- Ships fully assembled and quickly mounts to the cabinet floor using four screws (included)
- UV-coated and edgebanded white birch plywood construction
- Features 100 lb. full-extension, soft-close, concealed undermount slides
- Compatible with NorthPoint Cabinetry® and all other cabinetry meeting the minimum openings listed below (see page 448 for reference guide)



Scan to watch the installation video
<https://delivr.com/2s2y4>

ROCWS21-WB



ROCWS15-WB



ROCWS21-WB



ROCWS27-WB

	Description	# Dividers	Width	Depth	Height	Min. Opening	Standard Cab. Size	Weight Capacity	Ctn Qty
ROCWS15-WB	Single-Drawer Cookware	5	13-9/16"	22-3/8"	9-1/16"	14-1/2"	18" base	100 lb.	1
ROCWS21-WB	Single-Drawer Cookware	7	19-1/8"	22-3/8"	9-1/16"	20-1/2"	24" base	100 lb.	1
ROCWS27-WB	Single-Drawer Cookware	9	25-1/8"	22-3/8"	9-1/16"	26-1/2"	30" base	100 lb.	1

Included screws: 4 #8 X1 Coarse-Thread Wood Screws



Optional: Use the drop-in 15-Bottle Grid to add bottle organization to any Single-Drawer Cookware Rollout

Description	Ctn Qty
ROACCBTGRID15 Accessory 15-Bottle Grid for Single-Drawer Cookware Rollout – Fits 15", 21", and 27" units	1

Base Cabinet Organization: Easy-to-Install Rollout Drawers



Scan to watch the product video
<http://delivr.com/2uf4p>

RO18-WB shown in use

**Skip the *measure...*
design...wait... process**

- Order rollout drawers that are **IN STOCK**
- Ships same day—Receive it in 2–3 days
- Ships fully assembled
- Easily and quickly installs with four screws (included)
- Designed to fit standard cabinet sizes



Rollout Drawers: 6" drawer height



For 15" opening
RO15-WB



For 18" opening
RO18-WB



For 21" opening
RO21-WB



For 24" opening
RO24-WB
1/2" bottom panel



For 27" opening
RO27-WB
1/2" bottom panel

Beautiful White Birch dovetail boxes with UV coating
 Featuring concealed undermount full-extension, soft-close slides
 Compatible with NorthPoint Cabinetry® and all other cabinetry meeting the minimum opening listed in the chart

	Width	Depth	Height	Bottom	Minimum Opening	Standard Cab. Size	Weight Capacity
RO12-WB	10-1/4"	21-1/4"	7"	1/4"	11-1/2"	15" base	100 lb.
RO15-WB	13-1/4"	21-1/4"	7"	1/4"	14-1/2"	18" base	100 lb.
RO18-WB	16-1/4"	21-1/4"	7"	1/4"	17-1/2"	21" base	100 lb.
RO21-WB	19-1/4"	21-1/4"	7"	1/4"	20-1/2"	24" base	100 lb.
RO24-WB	22-1/16"	21-1/4"	7"	1/2"	23-1/2"	27" base	100 lb.
RO27-WB	25-1/16"	21-1/4"	7"	1/2"	26-1/2"	30" base	100 lb.
RO33-WB	31-1/16"	21-1/4"	7"	1/2"	32-1/2"	36" base	100 lb.
ROVHB12-WB	10-1/16"	18-7/16"	9"	1/4"	11-1/2"	15" vanity	100 lb.
ROVHB15-WB	13-1/16"	18-7/16"	9"	1/4"	14-1/2"	18" vanity	100 lb.
ROVHB18-WB	16-1/16"	18-7/16"	9"	1/4"	17-1/2"	21" vanity	100 lb.

Base Cabinet Organization: Under-Sink Silicone Mat



- Protects sink base cabinets from damage caused by water leaks
- High-quality grey silicone material is easy to clean and features a stylish honeycomb pattern
- Flexible silicone material allows placement after the cabinets are assembled and countertop installed. Also works in cabinets with a center stile.
- Can be used in cabinets with wall plumbing, or the rear rectangle can be trimmed for floor plumbing
- Can be trimmed up to 3/4" to fit non-standard cabinet widths
- Designed to fit in a 36" sink base cabinet
- Designed to work with NorthPoint Cabinetry® and compatible with face frame or frameless cabinetry



USM-G



The sturdy 14 mm lip around the perimeter of the mat will hold 1.4 gallons of liquid

Description	Finish	Width	Depth	Height	Standard Cab. Size	Carton Quantity
USM-G NEW Under-Sink Silicone Mat	Grey	34-9/16"	22-5/16"	9/16"	36" base	1

CORNER ORGANIZATION



Storage with Style® Blind Corner Pullout
Pages 356-357



Blind Corner Swingout
Pages 350-351



Blind Corner Sliding Door
Pages 352-353



Half-Moon Lazy Susan
Page 369

Blind Corner Organization

With blind corner organizers from Hardware Resources, unused cabinet space is a thing of the past. Blind corner organizers bring forward items stored in the far back corner. Our Easy 360 Susan is a fresh and updated corner solution that is a hybrid of a lazy susan and pullout shelves.



Premium Wood Lazy Susan
Pages 358-362



Economy Plastic Lazy Susan
Page 367



Easy 360 Susan
Pages 354-355

Lazy Susan Corner Organization

The Hardware Resources line of lazy susan corner organizers includes tried-and-true round and kidney options in plastic and wood.

Blind Corner Organization: Swingout

Take full advantage of a blind corner cabinet with a swingout organizer to store large pots, pans, and other essential cookware



Scan to watch the installation video
<http://delivr.com/288f6>

Installation Screws Included



BCSO215PCMP-LH
Maple non-slip shelf



BCSO215PCWD-LH
Walnut textured non-slip shelf



BCSO215BOWD-LH
Walnut textured non-slip shelf

Sold as a complete unit in left- or right-handed versions for full-height base cabinets

Metal edging finishes coordinate with popular decorative hardware finishes

Easy installation—no need to drill into the side walls, mounts directly to cabinet floor with optional top mounting for additional stability

Installation instructions and mounting hardware included

BCSO215 fits in NorthPoint Cabinetry® (see page 449 for reference guide)



BCSO215PCWH-LH
White non-slip shelf



BCSO215GWH-LH
White smooth shelf

Do I need Left Hand or Right Hand?

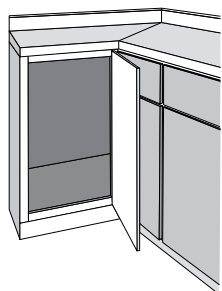

Left Hand blind corners have the opening on the **left**.

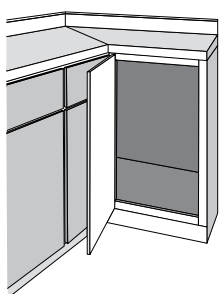

Right Hand blind corners have the opening on the **right**.

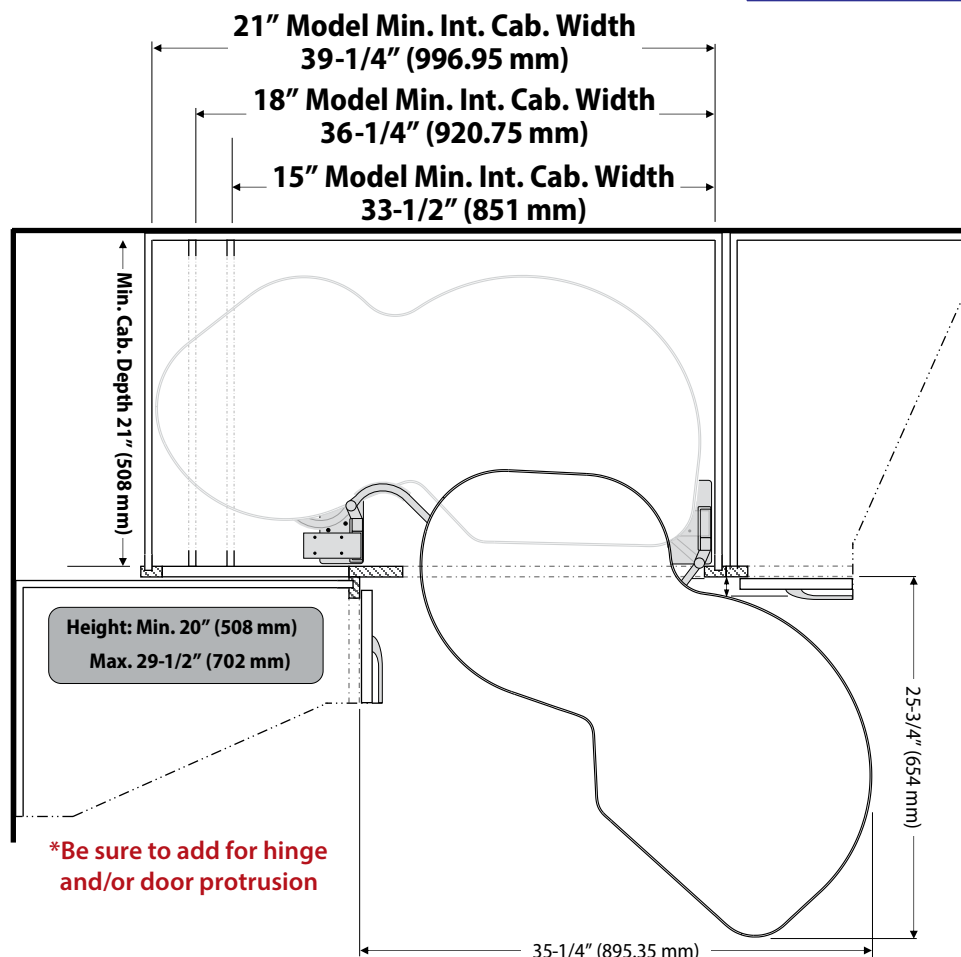

Left Handed	Right Handed	Frame Color	Shelf Bottom/Edging	Shelf Dimensions	Weight Capacity	Ctn Qty
PREMIUM OPTIONS - NON-SLIP COATED SHELVES, PLATED EDGING						
BCSO215BOWD-LH	BCSO215BOWD-RH	Oil Rubbed Bronze	Walnut/Oil Rubbed Bronze	31-1/2" x 14-1/4"	90 lb.	1
BCSO215PCMP-LH	BCSO215PCMP-RH	Grey	Maple/Polished Chrome	31-1/2" x 14-1/4"	90 lb.	1
BCSO215PCWD-LH	BCSO215PCWD-RH	Grey	Walnut/Polished Chrome	31-1/2" x 14-1/4"	90 lb.	1
BCSO215PCWH-LH	BCSO215PCWH-RH	Grey	White/Polished Chrome	31-1/2" x 14-1/4"	90 lb.	1
BCSO218BOWD-LH	BCSO218BOWD-RH	Oil Rubbed Bronze	Walnut/Oil Rubbed Bronze	32-13/16" x 16-3/4"	90 lb.	1
BCSO218PCMP-LH	BCSO218PCMP-RH	Grey	Maple/Polished Chrome	32-13/16" x 16-3/4"	90 lb.	1
BCSO218PCWD-LH	BCSO218PCWD-RH	Grey	Walnut/Polished Chrome	32-13/16" x 16-3/4"	90 lb.	1
BCSO218PCWH-LH	BCSO218PCWH-RH	Grey	White/Polished Chrome	32-13/16" x 16-3/4"	90 lb.	1
BCSO221BOWD-LH	BCSO221BOWD-RH	Oil Rubbed Bronze	Walnut/Oil Rubbed Bronze	37-7/16" x 18-3/8"	90 lb.	1
BCSO221PCMP-LH	BCSO221PCMP-RH	Grey	Maple/Polished Chrome	37-7/16" x 18-3/8"	90 lb.	1
BCSO221PCWD-LH	BCSO221PCWD-RH	Grey	Walnut/Polished Chrome	37-7/16" x 18-3/8"	90 lb.	1
BCSO221PCWH-LH	BCSO221PCWH-RH	Grey	White/Polished Chrome	37-7/16" x 18-3/8"	90 lb.	1
ECONOMY OPTIONS - SMOOTH FINISH SHELVES, POWDER COATED EDGING						
BCSO215GWH-LH	BCSO215GWH-RH	Grey	White/Grey	31-1/2" x 14-1/4"	90 lb.	1
BCSO218GWH-LH	BCSO218GWH-RH	Grey	White/Grey	32-13/16" x 16-3/4"	90 lb.	1
BCSO221GWH-LH	BCSO221GWH-RH	Grey	White/Grey	37-7/16" x 18-3/8"	90 lb.	1

Blind Corner Organization: Sliding Door

Keep your customers from digging around their blind corner cabinet—bring the back of the cabinet to their fingertips



4 heavy-gauge chrome baskets with non-slip clear acrylic basket liners

Heavy-duty soft-close slides with 200 lb. capacity

Soft-close door damper

Door mounting brackets with 6-way adjustment (in/out, up/down and left/right)

Flexible mounting options: secure to side walls or top of cabinet with adjustable brackets

Universal design—mount it left- or right-handed

For face frame applications, use with side wall blocking



Also great for dishes & small appliances



Mount it with or without door attached.



Scan to watch the
installation video
<http://delivr.com/22w9g>

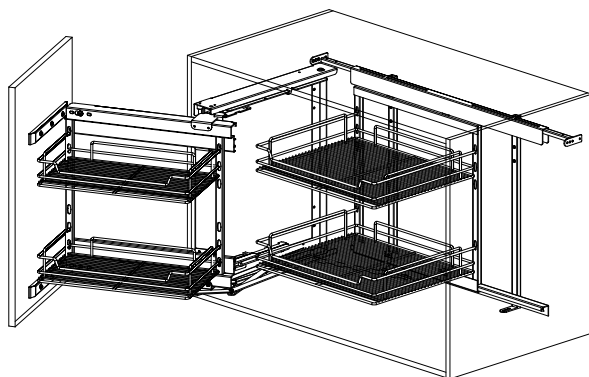

Large back basket:
18" W x 15-1/4" D x 3" H
Small front basket:
9-7/8" W x 17-3/16" D x 3" H

	Width	Depth	Height	Cabinet Size	Weight Capacity	Ctn Qty
CS-SDCO	30-7/8–38"	20-1/2"	21-5/8"	blind corner 15"–18" opening	200 lb.	1

Recommended screw:

#6 pan head

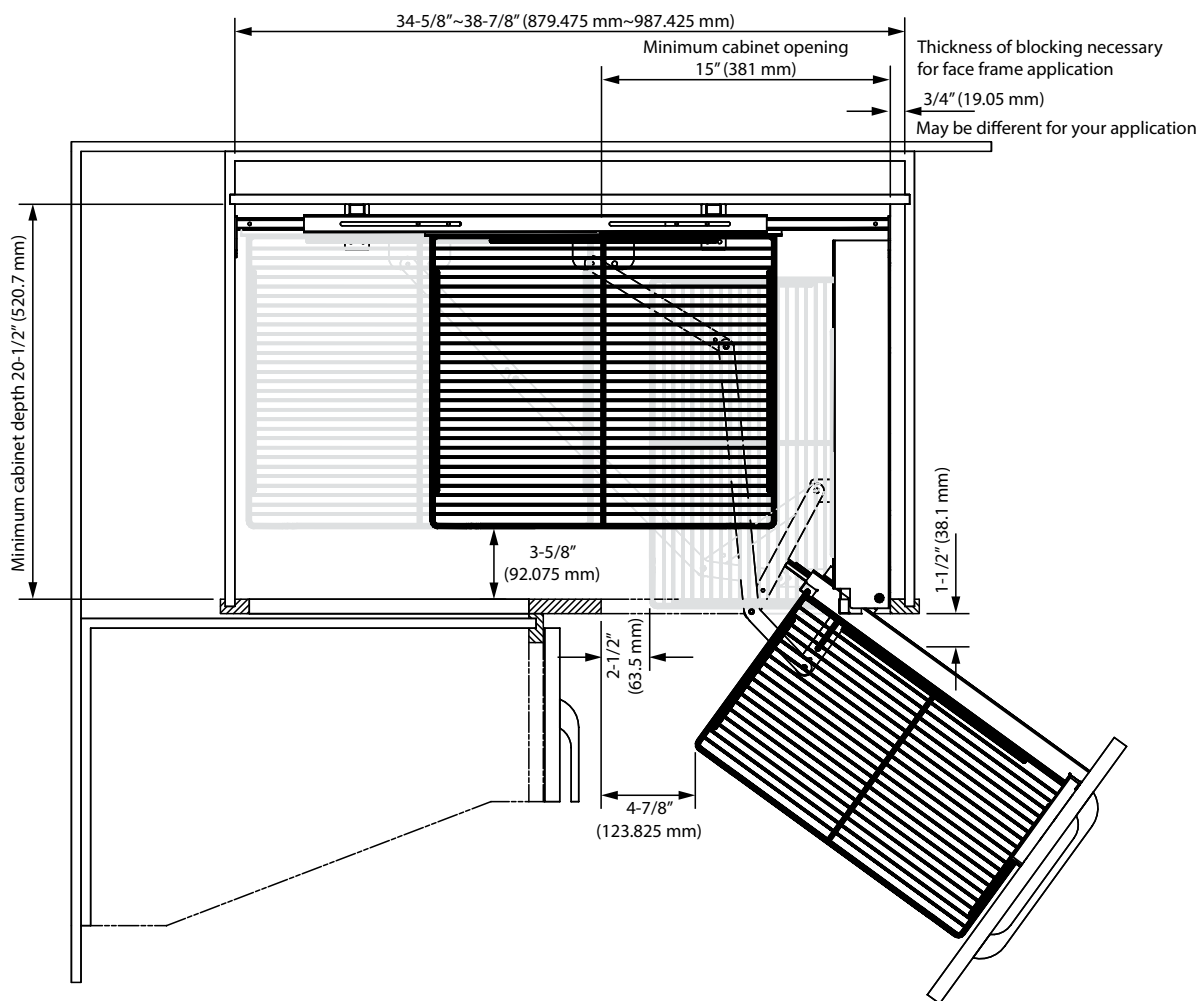

Corner Organization: Easy 360 Susan

Transform the corner cabinet from cumbersome to a versatile usable space by combining the convenience of a drawer with the benefits of a lazy susan



360°
rotating



Scan to watch the
installation video
<http://delivr.com/2vcyq>



- 6 heavy gauge chrome baskets with 6 non-slip clear acrylic basket liners
- Full circle 360 degree rotation, left or right
- Sliding center baskets are accessible from either front or back
- Heavy-duty 175 lb. total capacity
- Adjustable height 24" to 30" inches
- Both shelves rotate together
- Compatible with NorthPoint Cabinetry® and all other cabinetry meeting the minimum size requirements

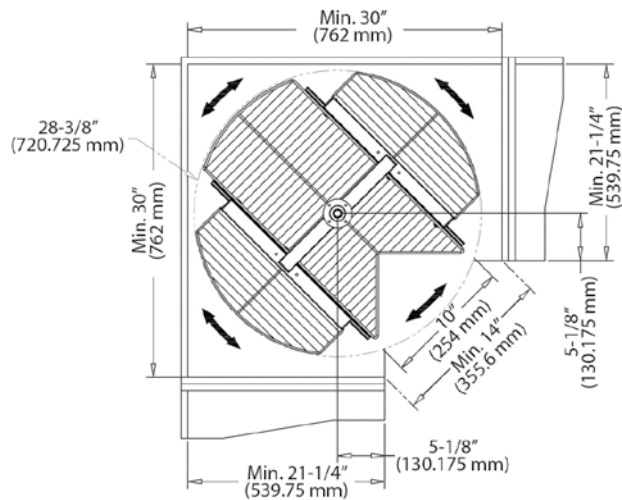

Cabinet requirements:

- Diameter: 30" (762 mm)
- Depth: 21-1/4" (539.75 mm)
- Pie Cut diagonal opening*: 14" (355.6 mm)

*Be sure to add for hinge and/or door protrusion

	Diameter	Height	Cabinet Size	Weight Capacity	Ctn Qty
CS-ES360	28-3/8"	24-13/16"-30"	30" corner	175 lb.	1

Recommended screw: #6 pan head

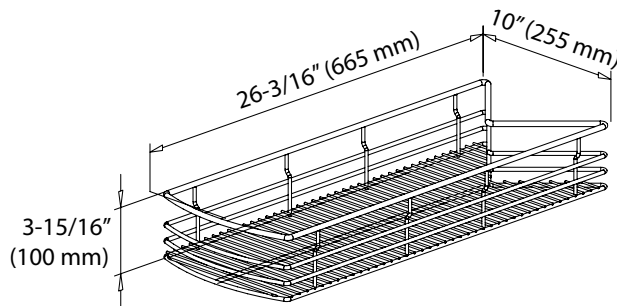
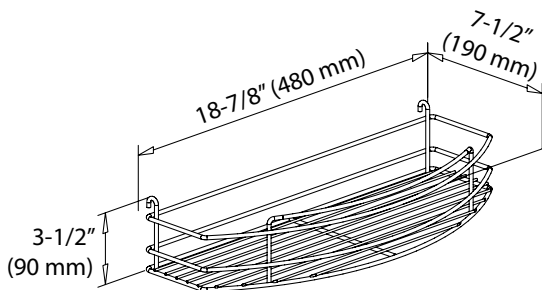

Corner Organization: Storage with Style Blind Corner Pullout

Bring the back of the cabinet within reach with this stylish organizer available in two trendy finishes



- All four baskets slide and pull out of the corner cabinet opening for full access
- Metal baskets are adjustable in height
- Universal design for left- or right-hand blind corners
- Available for standard and full-height blind corner cabinets. For full-height option, additional baskets can be added to make a three-tiered organizer (see image at right)
- Includes heavy-duty soft-close slides for smooth movement in and out of the cabinet (preinstalled)
- Heavy-duty frame construction ensures organizer is stable when in motion
- Acrylic liners add stability to baskets and are easy to clean
- Compatible with NorthPoint Cabinetry® and all other cabinetry meeting the minimum opening listed in the chart





Black Nickel

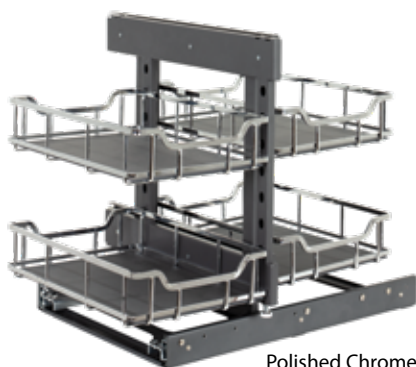

Polished Chrome

Item Number	Description	Frame Color	Width	Depth	Height	Standard Cabinet Size	Weight Capacity	Ctn Qty*
SWS-BCS15BN	Blind Corner Organizer for Standard-Height 15" Opening	Black Nickel	26-13/16"	22-1/8"	20-9/16"	Blind Corner with drawer	130 lb.	1
SWS-BCS15PC	Blind Corner Organizer for Standard-Height 15" Opening	Polished Chrome	26-13/16"	22-1/8"	20-9/16"	Blind Corner with drawer	130 lb.	1
SWS-BCS18BN	Blind Corner Organizer for Standard-Height 18" Opening	Black Nickel	32-7/8"	22-1/8"	20-9/16"	Blind Corner with drawer	130 lb.	1
SWS-BCS18PC	Blind Corner Organizer for Standard-Height 18" Opening	Polished Chrome	32-7/8"	22-1/8"	20-9/16"	Blind Corner with drawer	130 lb.	1
SWS-BCFH15BN†	Blind Corner Organizer for Full-Height 15" Opening	Black Nickel	26-13/16"	22-1/8"	24-1/16"	Blind Corner - full-height door	130 lb.	1
SWS-BCFH15PC†	Blind Corner Organizer for Full-Height 15" Opening	Polished Chrome	26-13/16"	22-1/8"	24-1/16"	Blind Corner - full-height door	130 lb.	1
SWS-BCFH18BN†	Blind Corner Organizer for Full-Height 18" Opening	Black Nickel	32-7/8"	22-1/8"	24-1/16"	Blind Corner - full-height door	130 lb.	1
SWS-BCFH18PC†	Blind Corner Organizer for Full-Height 18" Opening	Polished Chrome	32-7/8"	22-1/8"	24-1/16"	Blind Corner - full-height door	130 lb.	1
SWS-BCBAS15BN†	Pair of Extra Baskets for SWS-BCFH15 15" Opening	Black Nickel	12-3/16"	15-9/16"	3-9/16"	-	25 lb.	1
SWS-BCBAS15PC†	Pair of Extra Baskets for SWS-BCFH15 15" Opening	Polished Chrome	12-3/16"	15-9/16"	3-9/16"	-	25 lb.	1
SWS-BCBAS18BN†	Pair of Extra Baskets for SWS-BCFH18 18" Opening	Black Nickel	15-3/16"	15-9/16"	3-9/16"	-	25 lb.	1
SWS-BCBAS18PC†	Pair of Extra Baskets for SWS-BCFH18 18" Opening	Polished Chrome	15-3/16"	15-9/16"	3-9/16"	-	25 lb.	1

Screws included

†Full-height door required *Ships in two boxes

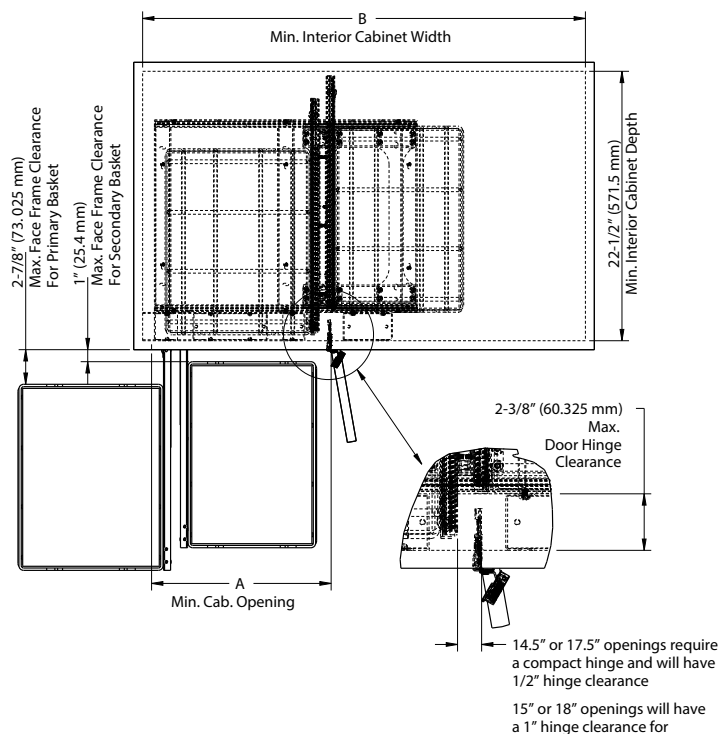

	Door Opening Height	A	B
SWS-BCS15BN	20-9/16"	14-1/2"	27"
SWS-BCS15PC	20-9/16"	14-1/2"	27"
SWS-BCS18BN	20-9/16"	17-1/2"	33"
SWS-BCS18PC	20-9/16"	17-1/2"	33"
SWS-BCFH15BN	24-1/16"	14-1/2"	27"
SWS-BCFH15PC	24-1/16"	14-1/2"	27"
SWS-BCFH18BN	24-1/16"	17-1/2"	33"
SWS-BCFH18PC	24-1/16"	17-1/2"	33"



Scan to watch the installation video
<https://delivr.com/2xyyp>

Corner Organization: Premium Wood Lazy Susan Kits



Scan to watch the
installation video
<http://delivr.com/276SA>

Corner Organization: Premium Wood Lazy Susan Kits

Lazy susan shelf is made from birch plywood with UV finish
 Solid birch finger jointed rim
 Shelves have a 1" inside rim height and 1-5/8" overall height
 Independently rotating shelves
 Positive stop on kidney shelf units
 Chrome-plated pole with stylish chrome hubs featuring adjustable height
 Sold as complete set with shelves, poles, mounting hardware and instructions included
 Compatible with NorthPoint Cabinetry® and all other cabinetry meeting the minimum size requirements

*Twist and Lock Pole
for Easy Installation*



Round	# Shelves	Diameter	Interior Cabinet Height	Weight Capacity per Shelf	Ctn Qty
LSR218-SET	2	18"	21-1/2"–37-1/4"	26 lb.	1
LSR224-SET	2	24"	21-1/2"–37-1/4"	63 lb.	1
LSR228-SET	2	28"	21-1/2"–37-1/4"	86 lb.	1
LSR2318-SET	3	18"	31-1/2"–43"	26 lb.	1



Kidney	# Shelves	Diameter	Interior Cabinet Height	Weight Capacity per Shelf	Ctn Qty
LSK224-SET	2	24"	21-1/2"–37-1/4"	47 lb.	1
LSK228-SET	2	28"	21-1/2"–37-1/4"	65 lb.	1
LSK232-SET	2	32"	21-1/2"–37-1/4"	84 lb.	1



Corner Organization: Premium Wood Shelves & Poles



*Poles & Shelves
Sold Separately*

Corner Organization: Premium Wood Shelves & Poles



Constructed with strong 5/8" thick birch plywood base and 1" inside height solid birch finger jointed rim
Clear UV finish
Available with and without 1-1/2" center hole for shelf or pole installation
32" is compatible with NorthPoint Cabinetry® and all other cabinetry meeting the minimum size requirements

Shelves	Diameter	Height	Weight Capacity per Shelf	Ctn Qty
LSK24	24"	1-5/8"	47 lb.	4
LSK28	28"	1-5/8"	65 lb.	4
LSK32	32"	1-5/8"	84 lb.	4
LSK24H	24" with hole	1-5/8"	47 lb.	4
LSK28H	28" with hole	1-5/8"	65 lb.	4
LSK32H	32" with hole	1-5/8"	84 lb.	4

Recommended screw: #6 pan head



Heavy-duty steel pole system for 2 kidney shelves, measures 16-1/2" in overall height with shelves installed
Kidney with 1-1/2" hole installs to bottom shelf, kidney without hole installs to top shelf – both shelves feature positive stop to self-align with pie corner
Powder coated almond finish blends with wooden shelves and matches most applications

Poles	Height	Ctn Qty
LSP2 (2 shelves)	16-1/2"	4

Recommended screw: #8 pan head

Corner Organization: Premium Wood Swivel Lazy Susans



top view



bottom view



swivel



Lazy susan made from strong 5/8" birch plywood base with 1" inside height solid birch finger jointed rim, all with a clear UV finish

Preinstalled with a high quality cast aluminum swivel with solid steel bearings

Swivel is non-stop for continuous smooth revolutions

Easy to install, minimal installation time, 4 screws included

Matching color plastic cap included to cover installation hole in lazy susan

18" is compatible with NorthPoint Cabinetry® and all other cabinetry meeting the minimum size requirements

Round	Diameter	Shelf Height	Swivel Size	Weight Capacity per Shelf	Ctn Qty
LSR18-S	18"	1-5/8"	7"	26 lb.	4
LSR24-S	24"	1-5/8"	7"	63 lb.	4
LSR28-S	28"	1-5/8"	10"	86 lb.	4

Lazy susan made from strong 5/8" birch plywood base with 1" inside height solid birch finger jointed rim, all with a clear UV finish

Preinstalled with a high quality cast aluminum swivel with solid steel bearings

360° swivel with stop

Easy to install, minimal installation time, 4 screws included

32" is compatible with NorthPoint Cabinetry® and all other cabinetry meeting the minimum size requirements



top view



bottom view



swivel with stop

Kidney	Diameter	Shelf Height	Swivel Size	Weight Capacity per Shelf	Ctn Qty
LSK28-S	28"	1-5/8"	10" with stop	65 lb.	4
LSK32-S	32"	1-5/8"	10" with stop	84 lb.	4

Scan to watch the installation video
<http://delivr.com/2GNPF>



Corner Organization: Economy Wire Swivel Lazy Susan

Cabinet
Organizers

360°
rotating

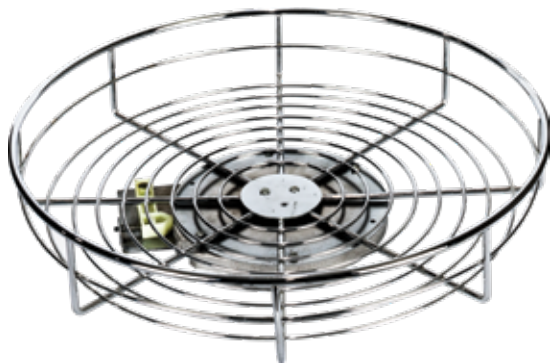

360 degree revolving tray
Great for organizing dry goods and cans
Fits 24" diagonal wall corner cabinet
Heavy-duty wire construction
Quickly mounts to cabinet floor or fixed shelf using
four screws (included)
Compatible with NorthPoint Cabinetry® and all other
cabinetry meeting the minimum size requirements



	Description	Finish	Diameter	Height	Fits Standard Cabinet Size	Weight Capacity	Ctn Qty
MLSR18-S-R	Single Shelf Lazy Susan	Polished Chrome	17-5/16"	3-13/16"	24" diagonal wall corner	30 lb.	1

Corner Organization: Economy Banded Swivel Lazy Susans

Round	Diameter	Swivel Size	Weight Capacity per Shelf	Ctn Qty
BLSR18-S	18"	8"	26 lb.	4
BLSR20-S	20"	8"	38 lb.	4
BLSR24-S	24"	8"	63 lb.	4
BLSR28-S	28"	9"	86 lb.	4



top view



bottom view



Lazy susan made from birch plywood with clear UV finish
 1" inside rim height and 1-9/16" overall height
 Preinstalled with a steel swivel
 Swivel is nonstop for continuous smooth revolutions
 Easy to install, minimal installation time, 4 screws included
 Matching color plastic cap included to cover installation hole in lazy susan
 Compatible with NorthPoint Cabinetry® and all other cabinetry meeting the minimum size requirements



Kidney	Diameter	Swivel Size	Weight Capacity per Shelf	Ctn Qty
BLSK28-S	28"	8" with stop	65 lb.	4
BLSK32-S	32"	9" with stop	84 lb.	4



top view



bottom view



Lazy susan made from birch plywood with clear UV finish
 1" inside rim height and 1-9/16" overall height
 Preinstalled with a steel swivel
 360° swivel with stop
 Easy to install, minimal installation time, 4 screws included
 Compatible with NorthPoint Cabinetry® and all other cabinetry meeting the minimum size requirements



Scan to watch the installation video
<http://delivr.com/2M9W7>

Corner Organization: Economy Banded Lazy Susan Kits

*Twist and Lock Pole
for Easy Installation*

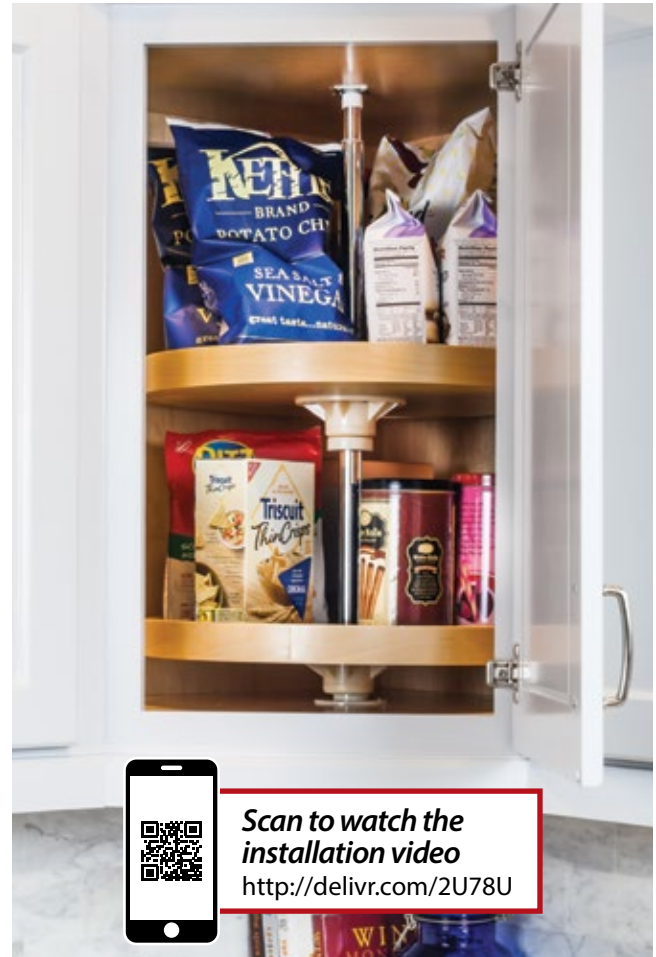

Scan to watch the
installation video
<http://delivr.com/2U78U>

Round	# Shelves	Diameter	Interior Cabinet Height	Weight Capacity per Shelf	Ctn Qty
BLSR218-SET	2	18"	24-1/2"-32-3/4"	26 lb.	1
BLSR220-SET	2	20"	24-1/2"-32-3/4"	38 lb.	1
BLSR224-SET	2	24"	24-1/2"-32-3/4"	63 lb.	1
BLSR228-SET	2	28"	24-1/2"-32-3/4"	86 lb.	1
BLSR2318-SET	3	18"	37-3/8"-46"	26 lb.	1
BLSR2320-SET	3	20"	37-3/8"-46"	38 lb.	1

Kidney	# Shelves	Diameter	Interior Cabinet Height	Weight Capacity per Shelf	Ctn Qty
BLSK224-SET	2	24"	24-1/2"-32-3/4"	47 lb.	1
BLSK228-SET	2	28"	24-1/2"-32-3/4"	65 lb.	1
BLSK232-SET	2	32"	24-1/2"-32-3/4"	84 lb.	1

Shelf is made from birch plywood with clear UV finish

Shelves have a 1" inside rim height and 1-9/16" overall height

Independently rotating shelves

Chrome pole with beige polymer plastic bearings that blend with wooden shelves

Pole features adjustable shelves

Positive stop on kidney shelf units

Height adjustable for cabinets with 25-3/4" - 32-3/4" interior heights (37-3/8" - 46" for 3 tier)

Sold as complete set with shelves, poles, mounting hardware and instructions included

Compatible with NorthPoint Cabinetry® and all other cabinetry meeting the minimum size requirements

Corner Organization: Plastic Lazy Susan with Chrome Hub Kits



- Independently rotating shelves featuring smooth surface area
- Chrome-plated stainless steel pole with chrome-plated hubs and adjustable height
- Pole features adjustable shelves
- Positive stop on kidney shelf units
- 18" diameter shelves have 1-7/16" overall rim height and 9/16" inside rim height
- 24" and 28" diameter shelves have 1-7/8" overall rim height and 1" inside rim height
- 32" diameter shelves have 2-1/8" overall rim height and 1-3/8" inside rim height
- Sold as complete set with shelves, poles, mounting hardware, and instructions included
- Compatible with NorthPoint Cabinetry® and all other cabinetry meeting the minimum size requirements



Scan to watch the installation video
<http://delivr.com/2D4U3>

Round	# Shelves	Diameter	Interior Cabinet Height	Weight Capacity per Shelf	Ctn Qty
PLSMR18	2	18"	21-1/2"–37-1/4"	26 lb.	1
PLSMR24	2	24"	21-1/2"–37-1/4"	63 lb.	1
PLSMR28	2	28"	21-1/2"–37-1/4"	86 lb.	1
PLSMR318	3	18"	31-1/2"–43"	26 lb.	1



Kidney	# Shelves	Diameter	Interior Cabinet Height	Weight Capacity per Shelf	Ctn Qty
PLSMK24	2	24"	21-1/2"–37-1/4"	47 lb.	1
PLSMK28	2	28"	21-1/2"–37-1/4"	65 lb.	1
PLSMK32	2	32"	21-1/2"–37-1/4"	84 lb.	1

Corner Organization: Economy Plastic Lazy Susan Kits

*Twist and Lock Pole
for Easy Installation*



**Twist
clockwise
to lock**

**Counter
clockwise
to release**



**Installation
Screws
Included**

Round	# Shelves	Diameter	Interior Cabinet Height	Weight Capacity per Shelf	Ctn Qty
PLSR218	2	18"	21-1/2"-37-1/4"	26 lb	1
PLSR224	2	24"	21-1/2"-37-1/4"	63 lb	1
PLSR228	2	28"	21-1/2"-37-1/4"	86 lb	1
PLSR2318	3	18"	31-1/2"-43"	26 lb	1



**Scan to watch the
installation video**
<http://delivr.com/2XKDZ>



*Twist and
Lock Pole*



**Installation
Screws
Included**



Kidney	# Shelves	Diameter	Interior Cabinet Height	Weight Capacity per Shelf	Ctn Qty
PLSK224	2	24"	21-1/2"-37-1/4"	47 lb	1
PLSK228	2	28"	21-1/2"-37-1/4"	65 lb	1
PLSK232	2	32"	21-1/2"-37-1/4"	84 lb	1

- Independently rotating shelves featuring smooth surface area
- Chrome-plated stainless steel pole with white polymer plastic hubs and adjustable height
- Pole features adjustable shelves
- Positive stop on kidney shelf units
- 18" diameter shelves have 1-7/16" overall rim height and 9/16" inside rim height
- 24" and 28" diameter shelves have 1-7/8" overall rim height and 1" inside rim height
- 32" diameter shelves have 2-1/8" overall rim height and 1-3/8" inside rim height
- Sold as complete set with shelves, poles, mounting hardware, and instructions included
- Compatible with NorthPoint Cabinetry® and all other cabinetry meeting the minimum size requirements

Corner Organization: Plastic Pie-Cut Lazy Susan



Door attaches directly to lazy susan

Available in 24" and 28" diameters

Patented height adjustment wheel for fine tuning that is easily accessible

Cardboard template to streamline installation

Twist and lock pole

Designed for inset door application



Scan to watch the installation video
<http://delivr.com/285UG>



Twist and Lock Pole for Easy Installation



Description	Diameter	Height	Weight Capacity per Shelf	Standard Cabinet Size	Ctn Qty
PLSP24 24" Pie-cut lazy susan with 2 shelves	24"	adjustable 25-7/8"-32"	47 lb.	lazy susan base corner	1
PLSP28 28" Pie-cut lazy susan with 2 shelves	28"	adjustable 25-7/8"-32"	65 lb.	lazy susan base corner	1

Installation screws included

Corner Organization: Half-Moon Lazy Susans

Cabinet
Organizers

- One model for both left-hand and right-hand installs
- Shelves mount from underside or a clean look and ease of cleaning
- Gives easy access to the hard to reach areas of a blind corner
- Available in wood or plastic shelves
- Available in 3 sizes: 12", 15" and 18"
- Compatible with NorthPoint Cabinetry® and all other cabinetry meeting the minimum size requirements



Scan to watch the
installation video
<http://delivr.com/2HX9R>



	Description	Width	Depth	Height	Standard Cabinet Size	Weight Capacity per Shelf	Ctn Qty
WOOD SETS	HMLS-W-3212 32" Half-Moon Lazy Susan Set - Wood Shelves	31-1/16"	14-1/4"	17-5/16"	blind corner	35 lb.	1
	HMLS-W-3515 35" Half-Moon Lazy Susan Set - Wood Shelves	33-9/16"	17-3/16"	17-5/16"	blind corner	46 lb.	1
	HMLS-W-3818 38" Half-Moon Lazy Susan Set - Wood Shelves	37-11/16"	19-11/16"	17-5/16"	blind corner	60 lb.	1
PLASTIC SETS	HMLS-P-3212 32" Half-Moon Lazy Susan Set - Plastic Shelves	31-1/16"	14-1/4"	17-5/16"	blind corner	34 lb.	1
	HMLS-P-3515 35" Half-Moon Lazy Susan Set - Plastic Shelves	33-9/16"	17-3/16"	17-5/16"	blind corner	45 lb.	1
	HMLS-P-3818 38" Half-Moon Lazy Susan Set - Plastic Shelves	37-11/16"	19-11/16"	17-5/16"	blind corner	60 lb.	1

Installation screws included

Lazy Susan Spec Drawings

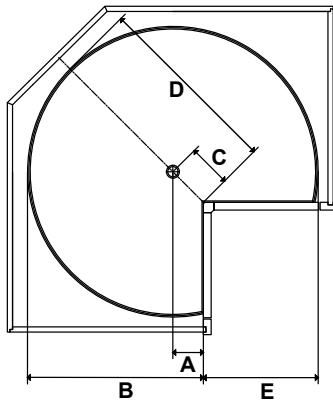

Plastic Lazy Susans - Pie Cut

Shelf	Series	A	B	C	D	E
24" Pie Cut	PLSP24	1-5/16"	13-3/8"	1-3/4"	13-15/16"	10-5/8" + 1/8" GAP
28" Pie Cut	PLSP28	2-15/16"	16-15/16"	4-5/32"	18-5/32"	11-1/8" + 1/8" GAP

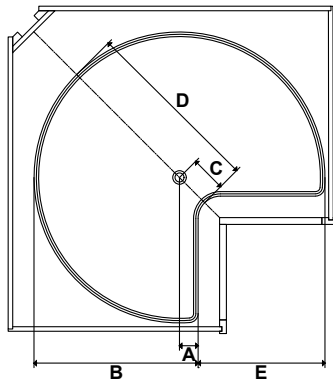

Plastic Lazy Susans - Kidney

Shelf	Series	A	B	C	D	E
24" Kidney	PLSK224	2-1/16"	14-1/16"	3-15/16"	15-15/16"	9-15/16"
28" Kidney	PLSK228	2-1/16"	16-1/16"	3-13/32"	17-13/32"	11-15/16"
32" Kidney	PLSK232	2-1/16"	18-1/16"	3-29/32"	19-29/32"	13-15/16"

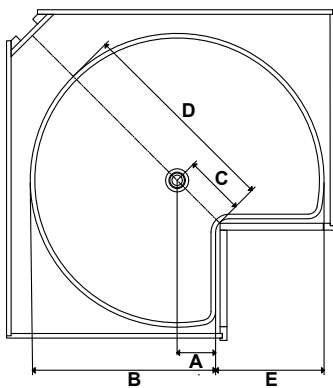

Wood Banded Lazy Susans - Kidney

Shelf	Series	A	B	C	D	E
24" Kidney	BLSK224	1-29/32"	13-29/32"	2-23/32"	14-23/32"	10-3/32"
28" Kidney	BLSK228	3-1/32"	17-1/32"	4-9/32"	18-9/32"	10-31/32"
32" Kidney	BLSK232	4-3/16"	20-3/16"	5-15/16"	21-15/16"	11-13/16"

Lazy Susan Spec Drawings

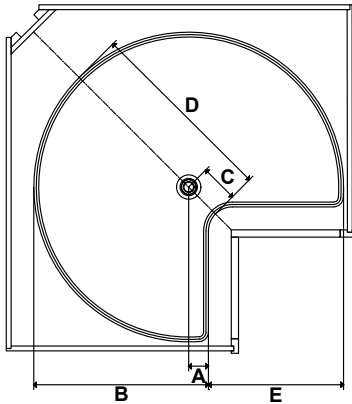

Plastic Lazy Susans with Chrome Hubs - Kidney

Shelf	Series	A	B	C	D	E
24" Kidney	PLSMK24	2-1/16"	14-1/16"	3-15/16"	15-15/16"	9-15/16"
28" Kidney	PLSMK28	2-1/16"	16-1/16"	3-13/32"	17-13/32"	11-15/16"
32" Kidney	PLSMK32	2-1/16"	18-1/16"	3-29/32"	19-29/32"	13-15/16"

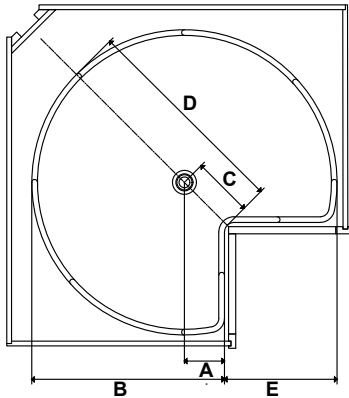

Premium Wood Lazy Susans - Kidney

Shelf	Series	A	B	C	D	E
24" Kidney	LSK224	1-29/32"	13-29/32"	2-23/32"	14-23/32"	10-3/32"
28" Kidney	LSK228	3-1/32"	17-1/32"	4-9/32"	18-9/32"	10-31/32"
32" Kidney	LSK232	4-3/16"	20-3/16"	5-15/16"	21-15/16"	11-13/16"

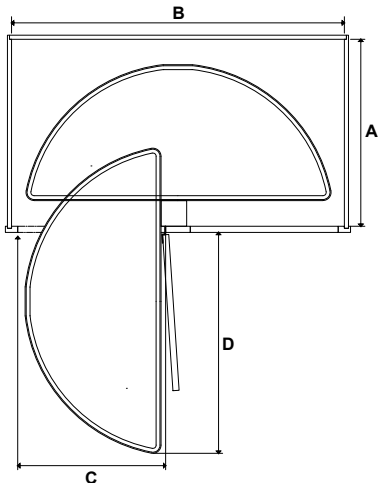

Lazy Susans - Half Moon

Shelf	Series	A	B	C	D
32" Plastic Half-Moon	HMLS-P-3512	22-1/2"	34-1/2"	12"	20-1/2"
35" Plastic Half-Moon	HMLS-P-3515	22-1/2"	37"	15"	22-9/16"
38" Plastic Half-Moon	HMLS-P-3518	22-1/2"	39-1/2"	18"	26-7/8"
32" Wood Half-Moon	HMLS-W-3512	22-1/2"	34-1/2"	12"	20-1/2"
35" Wood Half-Moon	HMLS-W-3515	22-1/2"	37"	15"	22-9/16"
38" Wood Half-Moon	HMLS-W-3518	22-1/2"	39-1/2"	18"	26-7/8"

PANTRY ORGANIZATION



Wood Pullout
Page 377

Pantry Organization

Organize everyone's favorite spot in the kitchen with a Hardware Resources pantry solution. From the traditional pantry pullout to our innovative pantry swingout, we have a solution for pantry storage needs.



**Wood Swingout &
Door Mount**
Pages 378-379



Wood Pullout
Page 377



Chrome Pullout
Page 376



Chrome Swingout
Pages 374-375



**Custom Drawer Boxes with
Pilaster System**
Page 380-383

Pantry Organizers: Premium Chrome Swingout

Pantry Storage that provides easy access to all stored items by pulling out of the cabinet and pivoting 90 degrees

90°
rotating



! Shown using
only 4 baskets.
● 5 baskets included.



Pantry Organizers: Premium Chrome Swingout

Cabinet
Organizers

- Features soft-close slides – 175 lb. weight capacity
- Smooth, quiet opening and closing motion
- Integrated door mounting brackets*
- Includes 5 heavy-duty wire baskets with chrome finish
- Basket placement is adjustable
- Non-slip clear acrylic basket liners included
- Frames adjust to fit variable heights
- Pivots 90° in each direction when fully extended
- For face frame or frameless cabinets**

*If door panel is less than 1/2" thick, additional material may need to be added to the rear of the door

**For face frame cabinet installation, additional cabinet blocking will be required for top mounting bracket.

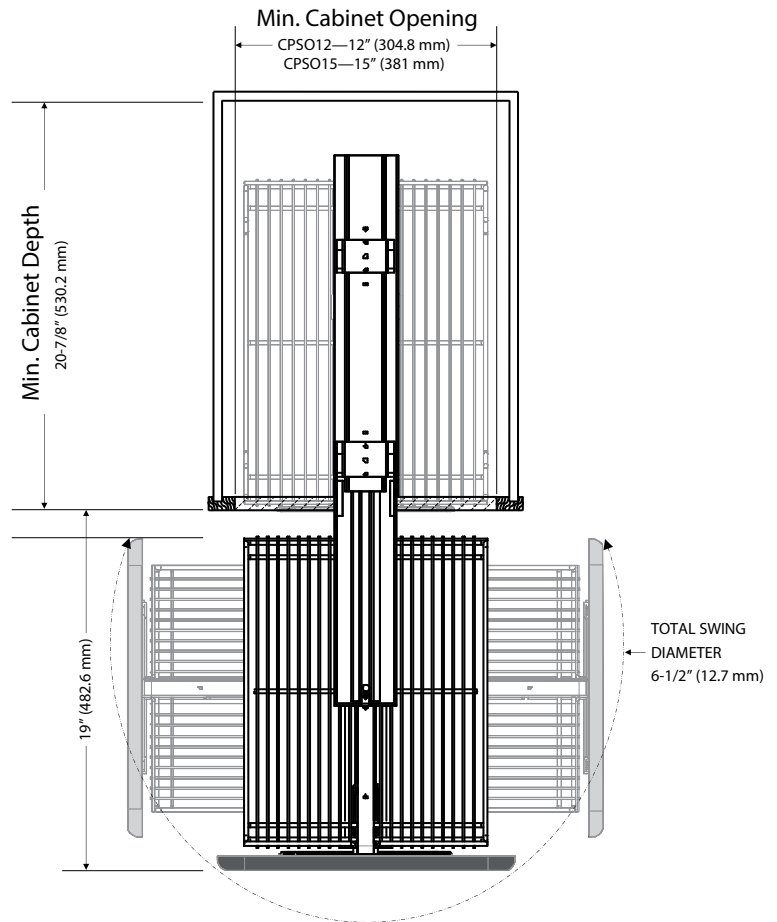

Scan to watch the
installation video
<http://delivr.com/2m8fn>



**FRAMELESS
FRIENDLY!**

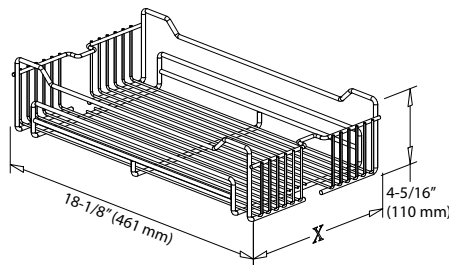

Cab. Opening	Basket Width (X)
For 12" opening	9-5/8"
For 15" opening	13-1/2"

	Width	Depth	Height	# of Baskets	Standard Cabinet Size	Weight Capacity	Ctn Qty
CPSO1274SC	9-7/8"	19-3/8"	61-7/16" to 74-13/16"	5	15" pantry with 12" opening	175 lb.	1
CPSO1286SC	9-7/8"	19-3/8"	73-1/4" to 86-5/8"	5	15" pantry with 12" opening	175 lb.	1
CPSO1574SC	13-9/16"	19-3/8"	61-7/16" to 74-13/16"	5	18" pantry with 15" opening	175 lb.	1
CPSO1586SC	13-9/16"	19-3/8"	73-1/4" to 86-5/8"	5	18" pantry with 15" opening	175 lb.	1

Recommended screw:

#6 pan head

hardware
resources

800.463.0660 | www.HardwareResources.com

[375]

Pantry Organizers: Premium Chrome Pullout

Pantry storage pulls fully out from the cabinet for easy access to the back of the shelf



- Features soft-close slides – 175 lb. total weight capacity
- Smooth, quiet opening and closing motion
- Integrated door mounting brackets*
- Heavy-duty wire baskets with chrome finish and non-slip clear acrylic basket liners
- Basket placement is adjustable
- Frames adjust to fit variable heights
- Extends fully out of the cabinet
- For face frame or frameless cabinets**

*If door panel is less than 1/2" thick, additional material may need to be added to the rear of the door

**For face frame cabinet installation, additional cabinet blocking will be required for top mounting bracket.



Scan to watch the installation video
<http://delivr.com/2s8ay>

FRAMELESS FRIENDLY!

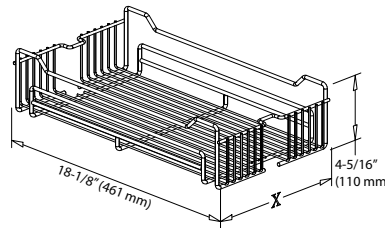

Cab. Opening	Basket Width (X)
For 12" opening	9-5/8"
For 15" opening	13-1/2"
For 18" opening	17-1/2"

	Width	Depth	Height	# Baskets	Standard Cabinet Size	Min. Opening	Weight Capacity	Ctn Qty
CPPO1263SC	9-7/8"	19-3/8"	49-5/8" to 63"	4	15" pantry with 12" opening	9-7/8"	175 lb.	1
CPPO1274SC	9-7/8"	19-3/8"	61-7/16" to 74-13/16"	5	15" pantry with 12" opening	9-7/8"	175 lb.	1
CPPO1286SC	9-7/8"	19-3/8"	73-1/4" to 86-5/8"	5	15" pantry with 12" opening	9-7/8"	175 lb.	1
CPPO1563SC	13-9/16"	19-3/8"	49-5/8" to 63"	4	18" pantry with 15" opening	13-9/16"	175 lb.	1
CPPO1574SC	13-9/16"	19-3/8"	61-7/16" to 74-13/16"	5	18" pantry with 15" opening	13-9/16"	175 lb.	1
CPPO1586SC	13-9/16"	19-3/8"	73-1/4" to 86-5/8"	5	18" pantry with 15" opening	13-9/16"	175 lb.	1
CPPO2063SC	17-1/2"	19-3/8"	49-5/8" to 63"	4	23" pantry with 20" opening	17-1/2"	175 lb.	1
CPPO2074SC	17-1/2"	19-3/8"	61-7/16" to 74-13/16"	5	23" pantry with 20" opening	17-1/2"	175 lb.	1
CPPO2086SC	17-1/2"	19-3/8"	73-1/4" to 86-5/8"	5	23" pantry with 20" opening	17-1/2"	175 lb.	1

Recommended screw:

#6 pan head

Pantry Organizers: Wood Pullout

Cabinet
Organizers

Wood pantry storage keeps items within arms reach by bringing the back of the cabinet to the front



- Solid white birch plywood construction with clear UV Finish
- Top shelf and bottom 2 shelves are fixed
- 2 adjustable middle shelves
- Ships preassembled and installs quickly
- Patented top mounting bracket eliminates side-to-side movement and sag
- Top mounting bracket allows for 3" of adjustability and can be used for frameless or face frame cabinetry
- 400 lb. heavy-duty ball bearing bottom slides and 225 lb. ball bearing top slide
- Patented integrated 6-way adjustable door mounting brackets allow for easy mounting of door
- Compatible with NorthPoint Cabinetry® and all other cabinetry meeting the minimum size requirements



Scan to watch the
installation video
<http://delivr.com/2ZRYV>

**FRAMELESS
FRIENDLY!**



U.S. PATENT

9,565,936 & 9,661,924
& 10,028,581

	Width	Depth	Height	# Shelves	Standard Cabinet Size	Min. Opening	Weight Capacity	Ctn Qty
PPO2-548	5-1/2"	22-1/2"	46" to 49"	5	9" pantry with 6" opening	5-1/2"	400 lb.	1
PPO2-554	5-1/2"	22-1/2"	52" to 55"	5	9" pantry with 6" opening	5-1/2"	400 lb.	1
PPO2-560	5-1/2"	22-1/2"	59" to 62"	5	9" pantry with 6" opening	5-1/2"	400 lb.	1
PPO2-848	8-1/2"	22-1/2"	46" to 49"	5	12" pantry with 9" opening	8-1/2"	400 lb.	1
PPO2-854	8-1/2"	22-1/2"	52" to 55"	5	12" pantry with 9" opening	8-1/2"	400 lb.	1
PPO2-860	8-1/2"	22-1/2"	59" to 62"	5	12" pantry with 9" opening	8-1/2"	400 lb.	1
PPO2-1148	11-1/2"	22-1/2"	46" to 49"	5	15" pantry with 12" opening	11-1/2"	400 lb.	1
PPO2-1154	11-1/2"	22-1/2"	52" to 55"	5	15" pantry with 12" opening	11-1/2"	400 lb.	1
PPO2-1160	11-1/2"	22-1/2"	59" to 62"	5	15" pantry with 12" opening	11-1/2"	400 lb.	1
PPO2-1448	14-1/2"	22-1/2"	46" to 49"	5	18" pantry with 15" opening	14-1/2"	400 lb.	1
PPO2-1454	14-1/2"	22-1/2"	52" to 55"	5	18" pantry with 15" opening	14-1/2"	400 lb.	1
PPO2-1460	14-1/2"	22-1/2"	59" to 62"	5	18" pantry with 15" opening	14-1/2"	400 lb.	1

Recommended screw:

#6 pan head



Extra Rails Ctn Qty

RAIL-17-PC	Extra rail for PPO2 series	50
------------	----------------------------	----

hardware
resources®

800.463.0660 | www.HardwareResources.com

[377]

Pantry Organizers: Wood Swingout

Hinged wooden shelves attach to vertical divider adding another layer of pantry storage. Pairs well with our wood door-mount racks.



- Used in pantry cabinets with recessed center divider
- Minimum opening 33" wide
- Top shelf and bottom 2 shelves are fixed
- 2 adjustable middle shelves
- Piano hinge allows left and right shelves to swing out
- Solid birch and birch plywood construction with clear UV finish
- Wings ship preassembled to center mounting strip



Scan to watch the installation video
<http://delivr.com/2fz83>



Extra Rails	Length	Height	Ctn Qty
RAIL-9-PC	9-1/4"	1-3/4"	50

	Width	Depth	Height	Standard Cabinet Size	Ctn Qty
A PSO45	25-15/16"	8"	45-5/8"	36" pantry	1

Recommended screw: #8 flat head

Pantry Organizers: Wood Door Mount

Reclaim the back of pantry doors for usable storage space. Pairs well with our wood swingout.



- Mounts to the inside of hinged pantry doors, minimum 48" tall and 13" wide
- Three adjustable middle shelves
- Solid birch and birch plywood construction with clear UV finish
- Ships preassembled and quickly installs to cabinet door, as pictured
- Can be used in conjunction with Pantry Swingout



	Width	Depth	Height	Standard Cabinet Size	Ctn Qty
B PDM45	12"	4-7/8"	45-5/8"	18" pantry door	1

Recommended screw: #8 flat head

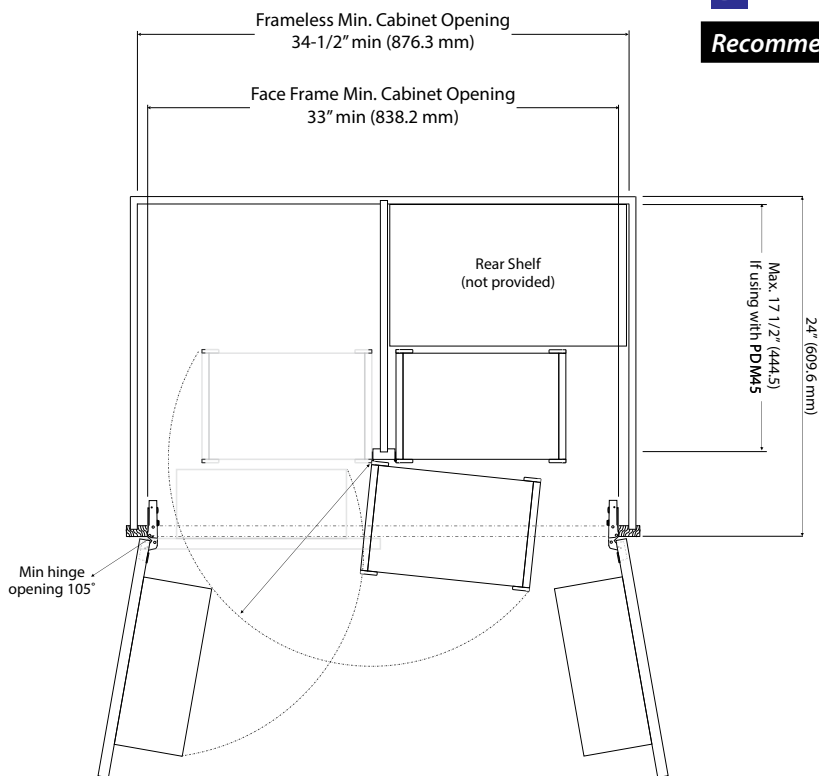

Extra Rails	Length	Height	Ctn Qty
RAIL-9-PC	9-1/4"	1-3/4"	50

Pantry Organizers: Build Your Own Rollouts



Rollout Box



Drawer Slide



QuickTray Pilaster System



CUSTOMIZED STORAGE SOLUTIONS

Maximize your kitchen with custom storage solutions.

Our custom order-to-size rollouts are manufactured in our plant in Louisiana. Add our best-selling Dura-Close® drawer slides and our QuickTray pilaster system, and you can create custom storage solutions for your customers.

Great for pantries, pot and lid storage, small kitchen appliances and miscellaneous kitchen wares. Customizable for any size cabinet, existing or new construction.



Pots & Lids



Pantry



Pantry Organizers: Quick Tray Pilaster System

**Cabinet
Organizers**



- » System only requires four simple components
- » Overall height is 20-1/8"
- » Vertical adjustment of shelves in increments of 1-1/4"
- » No tools necessary for shelf adjustments
- » Front spacing lip allows for offset behind the face frame
- » Supports are non-handed for easy installation
- » Frameless application can be mounted with wood or euro screws
- » Face frame application can be fastened with staples or wood screws
- » Can be factory installed or added to existing cabinets

Pilasters:

Maple	B512-01 5 pks/ctn	1-1/4" Pilaster System Pack, clear-coated maple pilaster with beige insert Pack Includes: 4 pilasters, 8 undermount hook dowels* and 16 screws
	B500-00 100 pks/ctn	Quick Tray 1" Pilaster bulk pack Pack Includes: 100 pilasters, 200 undermount hook dowels* and 200 screws
White	B520-00 20 pks/ctn	1" Pilaster System Pack Pack Includes: 4 pilasters, 8 undermount hook dowels* and 8 screws
	B521-00 20 pks/ctn	1-1/4" Pilaster System Pack Pack Includes: 4 pilasters, 8 undermount hook dowels* and 8 screws
	B520-01 20 pks/ctn	1" Pilaster System Pack Pack Includes: 4 pilasters, 8 undermount hook dowels* and 8 screws
Beige	B521-01 20 pks/ctn	1-1/4" Pilaster System Pack Pack Includes: 4 pilasters, 8 undermount hook dowels* and 8 screws

Use with any slide:

UNDERMOUNT



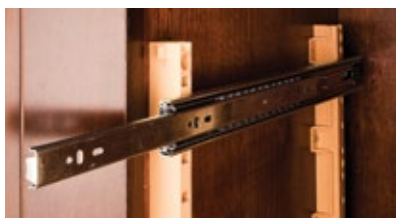

BALL BEARING

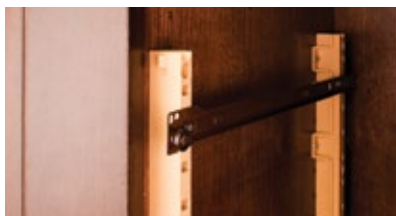

EPOXY



Accessories:

White	530117 2,000 pc/ctn	7/8" Plastic Spacer with 1-3/8" CC holes 1-7/8" overall width	
	EXE001 2,000 pc/ctn	3/4" Spacer with 32 mm holes	
Beige	B-400-02 100 pc/pk 10 pks/ctn	Drawer Bumper for Rollout Tray 11/16" (18 mm) Recommended screw: 6X7160-B	
Zinc	T-506 1,000 pc/ctn	Hook Dowels for ball bearing slides (sold individually)	
	T-508 1,000 pc/ctn	Hook Dowels for undermount slides (sold individually)	

*Ball bearing slide hook
dowels sold separately



Scan the QR Code to view the
Quick Tray calculation sheet or
visit <https://delivr.com/2hwjs>

**hardware
resources®**

800.463.0660 | www.HardwareResources.com

[381]

Pantry Organizers: Dovetail Drawer Boxes



Ordering specifications:

- Standard drawer, rollout, or high-back rollout boxes
- Assembled or unassembled
- Standard heights with custom depth & width
- 1/4" standard or 1/2" bottom
- Optional universal notch for undermount slides
- Optional undermount slide clip factory installed

Easy Online Ordering & Instant Price Quoting

See website for details

Production and delivery:

- Competitive pricing
- Standard 7-day turnaround after order confirmation
- Quick-to-ship production for qualifying states

- A** 5/8" Hard Maple UV Coated or Unfinished
- B** 5/8" Aspen UV Coated
- C** 5/8" White Birch, Imported, Finger Jointed..... UV Coated
- D** 5/8" Rustic White Birch, Imported, Finger Jointed.. UV Coated
- E** 5/8" Rubberwood, Imported, Finger Jointed UV Coated
- F** 1/2" Birch Plywood UV Coated or Unfinished
- G** 1/2" Birch Plywood Edgebanded UV Coated

HEIGHT OPTIONS	2"	2.5"	3"	3.5"	4"	5"	6"	7"	8"	9"	9.5"	10"	11"	12"
1/2" Birch Plywood	x	x	x	x	x	x	x	x	x	x	x	x	x	
1/2" Edgebanded Plywood		x	x		x	x	x	x	x	x		x	x	
5/8" Hardwoods	x	x	x	x	x	x	x	x	x	x	x	x	x	x
High-Back (all species)							x	x	x	x	x	x	x	x

*All high-back drawers will have a 3" front and a scoop cutout on the front face. 6" minimum height.

SIZING	Min. Depth	Max. Depth	Min. Width (without clips)	Min. Width (with clips)	Max. Width	Min. Height
Standard Drawer						
5/8" Material	7"	51"	6"	See table below	51"	2"
1/2" Material	7"	51"	6"	See table below	51"	2"
Rollout Drawer						
5/8" Material	7"	51"	6"	See table below	51"	2"
1/2" Material	7"	51"	6"	See table below	51"	2"
High-Back Rollout						
5/8" Material	12"	51"	5-1/2"	See table below	51"	6"
1/2" Material	12"	51"	5-1/2"	See table below	51"	6"

	US-CLIP2ND-XX	US-CLIP-2W	US-CLIP-NR	USCLIP500-2-XX
5/8" Material	7.25"	6.25"	4.875"	8.25"
1/2" Material	7"	6"	4.5"	8"

#6 x 5/8" pan head screw recommended for installation.

Drawer boxes are cut and assembled in the USA by Hardware Resources. Hard Maple and Aspen are North American hardwoods. White Birch and Rubberwood are imported A/B grade hardwood, Rustic White Birch is C/D grade hardwood laminated & finger jointed. Birch plywood is Carb Compliant 9-ply high density plywood with no internal voids. UV cured coating is 100% solid and contains no VOC. Each UV coated piece is double coated to ensure a lasting finish.

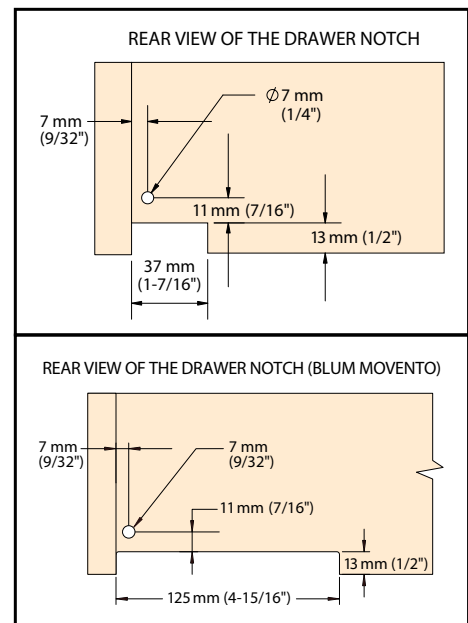



Pantry Organizers: Dovetail Drawer Boxes



High-Back Rollout
(minimum 6" height)



Rollout



Scan to calculate
drawer box sizes
<https://delivr.com/2e2qq>

Complimentary High Definition Laser Engraving on Hardwood Boxes

- Upcharge per box for plywood only
- Simply provide a high-resolution logo file. We'll do the rest!
- Accepted file types are EPS, AI, PDF, PSD, JPEG, PNG, TIFF
- Maximum logo size is 1-1/2" tall x 6" wide. Minimum box height for engraving is 3"
- Not available on high-back rollouts or boxes over 24" deep
- Placed on the front left inside edge of the box
- One logo per customer. Logos are kept on file for future orders
- *Don't have a logo? Choose from our preselected fonts to customize your company name*



Drawer Box Linear Material



White Birch, Finger Jointed

	Height	Thickness	Coating	Ctn Qty
DW58X030	3"	5/8"	UV Coated	80LF
DW58X035	3-1/2"	5/8"	UV Coated	80LF
DW58X040	4"	5/8"	UV Coated	80LF
DW58X060	6"	5/8"	UV Coated	40LF
DW58X080	8"	5/8"	UV Coated	40LF
DW58X100	10"	5/8"	UV Coated	40LF

White Birch drawer box linear material is sold in 8' lengths in full carton quantity only



Aspen

	Height	Thickness	Coating	Ctn Qty
DA58X030	3"	5/8"	UV Coated	80LF
DA58X040	4"	5/8"	UV Coated	80LF
DA58X060	6"	5/8"	UV Coated	72LF
DA58X080	8"	5/8"	UV Coated	56LF
DA58X100	10"	5/8"	UV Coated	56LF

Aspen drawer box linear material is sold in random lengths of 5' - 8'

Pantry Organizers: Custom Rollout Accessories

Slide Mounting Kit for Ball Bearing Slides



Custom dovetail drawer boxes,
303FU drawer slide and SLIDE-KIT shown in use



4 Zinc L-brackets & slide
attachment screws

SLIDE-KIT
50 pks/ctn

Recommended screw: #6 pan head

Perfect for rollout drawers—allows you to
mount slides directly to cabinet floor or
fixed shelf

Will fit 301FU series and 303FU series ball
bearing slides as well as USE series
undermount slides

Threaded collars mean secure attachment using
only a screwdriver

Screws for mounting to slides included

#6 pan head screw suggested for installation to cabinet floor



Pantry Organizers: Custom Rollout Accessories

Cabinet
Organizers

Rear Mounting Block for Undermount Slides



Custom dovetail drawer boxes, Quick Tray Pilaster System, USE58-300 drawer slide and USE-RMB shown in use



1 pair blocks &
attachment screws

USE-RMB
250 pks/ctn

Screws included

Attach rear mounting block to the back of the shelf
instead of notching and boring

For use with USE58-500 or USE58-300 undermount
slides

Maximum apron thickness 16 mm (5/8") for our
USE58 series slides

One pair of our drawer clips is required per shelf

Installation screws are provided

DRAWER ORGANIZATION



Angled Utensil Insert
Page 389

Drawer Organization

Tame drawer clutter with Hardware Resources' drawer organizers. From complete drawer organization to drop-in inserts, these products will help organize everything from cutlery to spices.



Double Coffee Drawer
Page 394



Coffee Pod Insert
Page 395



Cutlery Insert
Page 390

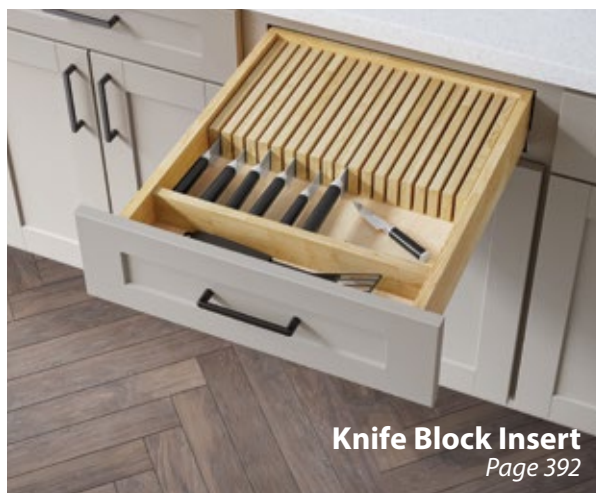

Knife Block Insert
Page 392

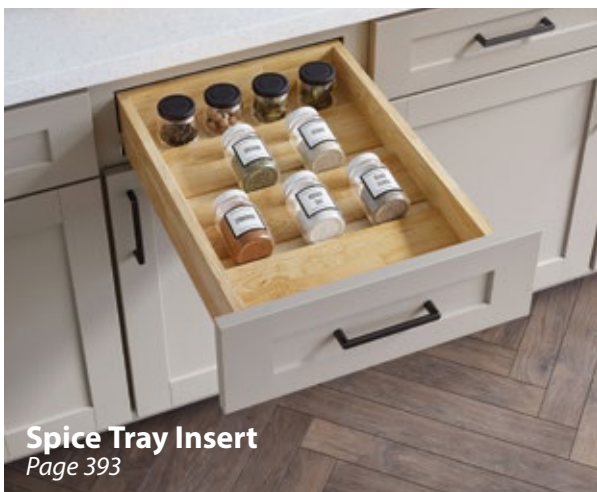

Spice Tray Insert
Page 393

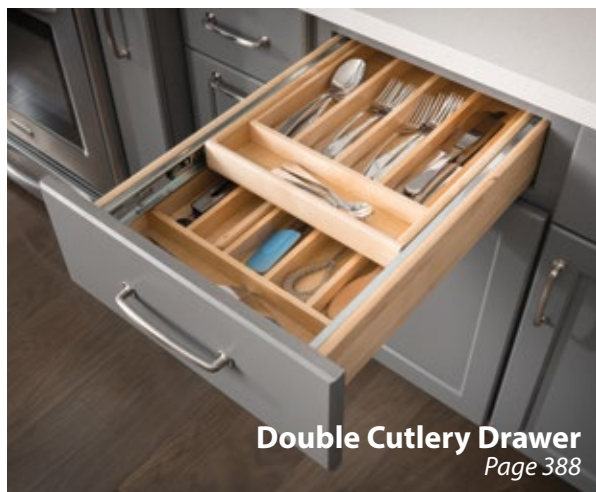

Double Cutlery Drawer
Page 388

Drawer Organizers: Double Cutlery Drawer

Replace a basic drawer with this two-tier organizer for maximized cutlery and silverware storage



Scan to watch the installation video
<http://delivr.com/2r2j4>

Make the most of space with this two tier system

Top tier includes preassembled full-extension ball bearing slides

Ships notched and bored for recommended use with USE58-300 undermount drawer slides (sold separately)

Drawer front not included

Made from 1/2" solid white birch dovetail drawer sides and 1/4" prefinished birch plywood bottoms, all with clear UV finish

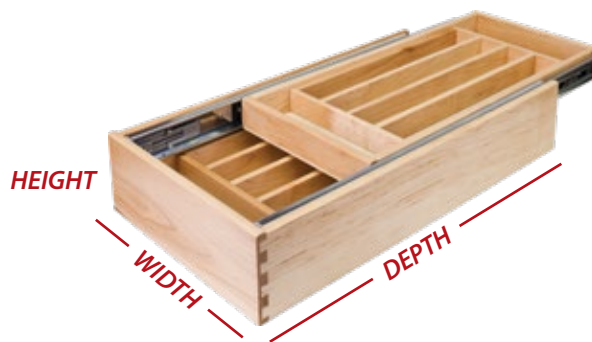

	Width	Depth	Height	Slide	Min Opening	Standard Cabinet Size	Weight Capacity	Ctn Qty
CD15	11-1/2"	21"	4-3/16"	100 lb.	12"	15" base	100 lb.	1
CD18	14-1/2"	21"	4-3/16"	100 lb.	15"	18" base	100 lb.	1
CD21	17-1/2"	21"	4-3/16"	100 lb.	18"	21" base	100 lb.	1

Drawer Organizers: Angled Utensil Insert

Cabinet
Organizers

Add this drop-in divider to keep oversize utensils organized in drawers



	Width	Depth	Height	Recommended Drawer	Ctn Qty
AU021-B24	19-3/16"	19-1/2"	2-1/2"	21" wide drawer*	3

*Item can be trimmed to fit smaller drawer

- Large 4" divider sections perfect for storing larger cooking utensils
- Designed to drop into a drawer with no installation needed
- Solid birch and birch plywood construction with clear UV finish
- Transition piece is included to use multiple inserts in wider drawers for a seamless look
- Compatible with NorthPoint Cabinetry® and all other cabinetry meeting the minimum size requirements

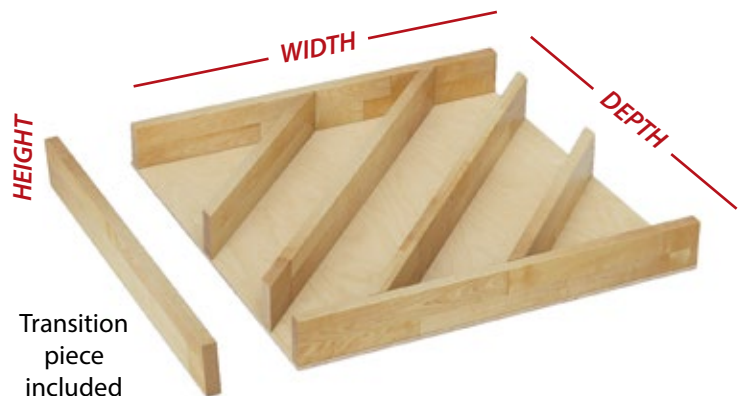

Drawer Organizers: Cutlery Insert

Easy drop-in installation makes this cutlery tray a no-brainer to add to drawers



	Width	Depth	Height	Recommended Drawer	Ctn Qty
DO15A-B18*	9" - 14"	19-1/2"	2-3/8"	15" wide drawer*	7
DO21A-B24*	15" - 20"	19-1/2"	2-3/8"	21" wide drawer*	7

*Item can be trimmed to fit smaller drawer

Adjustable width allows inserts to fit a variety of sized drawers

DO15A-B18 is adjustable from 9" Min to 14" Max

DO21A-B24 is adjustable from 15" Min to 20" Max

Cutlery sections are 2-3/8" wide

2-3/8" total height

Solid birch and birch plywood construction with clear UV finish

Sized to fit 15" and 21" drawers with no trimming needed

Transition piece is included to use multiple inserts in wider drawers for a seamless look

Compatible with NorthPoint Cabinetry® and all other cabinetry meeting the minimum size requirements

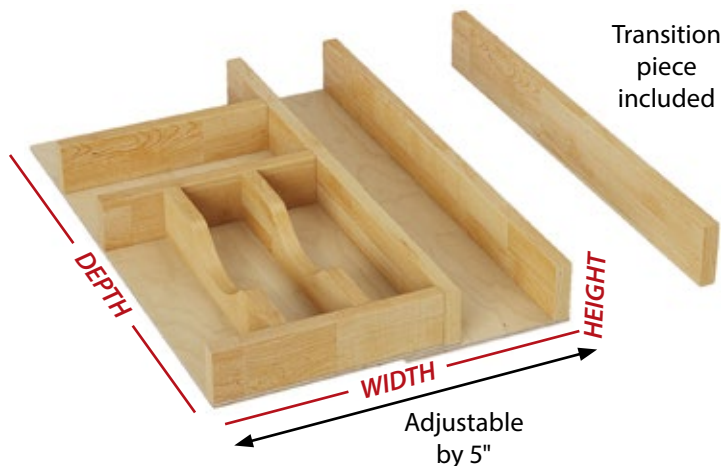

Drawer Organizers: SlimLine Cutlery Insert

Drop-in cutlery tray keeps the kitchen's most-used drawer organized—now with even more cubbies



	Width	Depth	Height	Recommended Drawer	Ctn Qty
CO15A NEW	9" - 14"	19-1/2"	2-3/8"	15" wide drawer	7
CO21A NEW	15" - 20"	19-1/2"	2-3/8"	21" wide drawer	7

SlimLine design made from thinner material for even more storage space

Adjustable width to fit a variety of sized drawers

Closed edge design for finished look

Extender piece included to allow up to 5" width adjustability

Trimnable depth for shallower drawers

White birch fingerjointed wood material

Compatible with NorthPoint Cabinetry® and all other cabinetry meeting the minimum size requirements

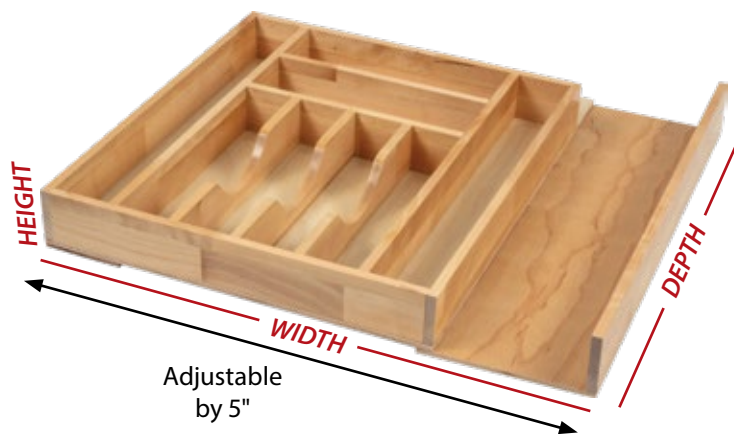

Drawer Organizers: Knife Block Insert

Store knives safely in a drawer with this knife block that also features a compartment for accessories like scissors or a sharpening tool



	Width	Depth	Height	Ctn Qty
KO18-B21*	16-3/16"	19-1/2"	2-3/8"	7

*Item can be trimmed to fit smaller drawer

- For use in 18" wide drawer
- Comes with 19 knife slots and built-in front storage partition
- Solid birch and birch plywood construction with clear UV finish
- Transition piece is included to use multiple inserts in wider drawers for a seamless look
- Designed to drop into a drawer with no installation needed
- Compatible with NorthPoint Cabinetry® and all other cabinetry meeting the minimum size requirements

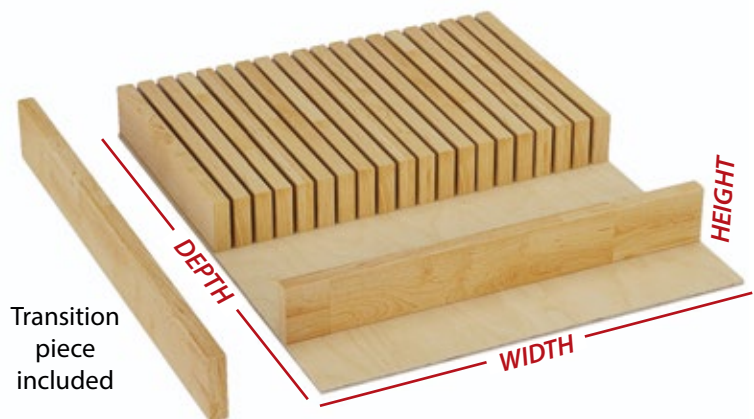

Transition piece included

Drawer Organizers: Spice Tray Insert

Cabinet
Organizers

This drop-in organizer stores small bottles and jars at an angle so that labels can be easily read



	Width	Depth	Height	Ctn Qty
SPO15-B18*	13-3/16"	19-1/2"	13/16"	7
SPO24-B27*	22-1/4"	19-1/2"	13/16"	6

*Item can be trimmed to fit smaller drawer

Holds wide variety of spice jars and containers
For use in 15" or 24" drawers or trim to size
Solid birch and birch plywood construction
with clear UV finish

Transition piece is included to use multiple
inserts in wider drawers for a seamless look
Designed to drop into a drawer with
no installation needed

Compatible with NorthPoint Cabinetry® and all
other cabinetry meeting the minimum size
requirements



Transition
piece
included

Drawer Organizers: Double Coffee Drawer



Easily replace a drawer in an 18" or 24" standard base cabinet for a customized coffee storage solution



Scan to watch the installation video
<https://delivr.com/2p33j>

KNCD21 shown in use

Your customers will love a coffee nook that includes our new double coffee drawer

- Double drawer design maximizes the storage potential while keeping coffee pods organized and out of sight
- Top tier includes full extension 100 lb. ball bearing slides preassembled to drawer box
- Birch hardwood construction with UV coating that is durable and easy to clean
- Recommended for use with full-extension undermount slides* (not included)
- Compatible with NorthPoint Cabinetry® and all other cabinetry meeting the minimum size requirements



KNCD15

Store 40 Keurig K-Cup® pods or **Nespresso® Original Line capsules with the 15" drawer or store 56 with the 21" drawer



KNCD21



The top coffee pod tray slides back to access the bottom tier for storage of sugar, creamer, tea, stir spoons, and more



**Convert top tray for Nespresso® Original Line capsules with included support board

	Description	Finish	Width	Depth	Height	Standard Cab. Size	Weight Capacity	Carton Quantity
KNCD15	NEW Double Coffee Drawer	UV Coated	14-1/2"	21"	4-3/16"	18" base	100 lb	1
KNCD21	NEW Double Coffee Drawer	UV Coated	20-1/2"	21"	4-3/16"	24" base	100 lb	1

*USE58-300-21 slides with USCLIP2ND-4W clips

Keurig K-Cup® pods are a trademark of Keurig products and Hardware Resources is not affiliated or endorsed by Keurig products. Nespresso® pods are a trademark of Nestlé products and Hardware Resources is not affiliated or endorsed by Nestlé products.

Drawer Organizers: Adjustable Drop-In Coffee Pod Insert

Maximize storage of coffee pods and accessories in an existing drawer with a drop-in organizer



SHIPS FULLY ASSEMBLED

KCCO15 shown in 18" wide cabinet with 14.5" wide drawer

A perfect fit: adjustable for an extra 5" width, and trimmable 2.5" depth
 Framed on all 4 sides for clean look
 Birch hardwood construction with UV coating that is durable and easy to clean
 Compatible with NorthPoint Cabinetry® and all other cabinetry meeting the minimum size requirements



KCCO15

Store 21 Keurig K-Cup® pods with the 15" insert or store 42 with the 21" insert



KCCO21

	Description	Finish	Width	Depth	Height	Standard Cab. Size	Carton Quantity
KCCO15	Adjustable Drop-In Coffee Pod Drawer Insert	UV Coated	9"-14"	19-1/2"	2-3/8"	15", 18" base	7
KCCO21 NEW	Adjustable Drop-In Coffee Pod Drawer Insert	UV Coated	15"-20"	19-1/2"	2-3/8"	21", 24" base	7

Keurig K-Cup® pods are a trademark of Keurig products and Hardware Resources is not affiliated or endorsed by Keurig products.

Drawer Organizers: Peg Board Insert

Tame drawer clutter and maximize storage with this trimmable-to-size insert and its variety of accessories



	# Pegs	Width	Depth	Height	Ctn Qty
PEG-9*	9	24-1/4"	21-1/4"	6-5/8"	1
PEG-12*	12	30-1/4"	21-1/4"	6-5/8"	1
PEG-16*	16	39-1/4"	21-1/4"	6-5/8"	1

*Item can be trimmed to fit smaller drawer

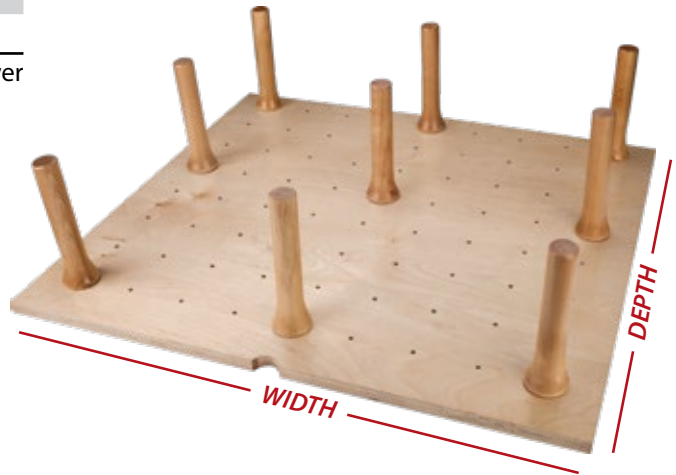

Pegs included - see table above for quantity
 Solid 5/8" birch plywood bottom panel with clear UV finish
 Press-in solid birch pegs with clear UV finish
 Ideal storage for dinnerware or plastic containers
 Designed to drop into a drawer with no installation needed
 All sizes can be trimmed to fit
 Compatible with NorthPoint Cabinetry® and all other cabinetry meeting the minimum size requirements



Additional Pegs	# Pegs	Top Diameter	Bottom Diameter	Height	Ctn Qty
PEG-BOX	4	1"	1-5/8"	6"	1

Press-in solid birch pegs with clear UV finish
 Use with PEG-9, PEG-12 or PEG-16

Drawer Organizers: Peg Board Accessories

Cookware is always within reach with these press-in organizers designed to work with our peg board insert



Pot/Pan Organizer

Holds up to five pots or pans and includes a handle rest
Adjustable dividers can be moved for a variety of configurations
Can be combined with Lid Organizer PEG-LO
Use with PEG-9, PEG-12, or PEG-16
Designed to drop into a drawer with no installation needed

Lid Organizer

Holds six lids
Can be combined with Pot Organizer PEG-PO
Use with PEG-9, PEG-12 or PEG-16
Designed to drop into a drawer with no installation needed

	Description	Width	Depth	Height	Ctn Qty
A	PEG-PO Pot Organizer	5-3/8"	15-3/16"	6-5/8"	1
B	PEG-LO Lid Organizer	5-3/16"	16-7/16"	5-7/16"	1



Drawer Organizers: Stainless Steel Tipout Tray

Reclaim wasted space in front of a sink by converting false drawers to usable storage



Convert false front drawers into useful hidden storage space

Sold as kits or individual trays and hinge pairs

Each kit includes 2 trays, 4 hinges, and screws

Stainless steel is durable and easily cleaned

Ships with all necessary hinges and screws

Hinges are self closing and feature adjustable opening angle

1-9/16" slim depth trays are great for use in low clearance applications behind large sinks

Compatible with NorthPoint Cabinetry® and all other cabinetry meeting the minimum size requirements



Kits	Width	Depth	Height	Standard Cabinet Size	Ctn Qty
TOSS11-R	11-11/16"	2"	3"	36" base	4 kits
TOSS11S-R	11-11/16"	1-9/16"	3"	36" base	4 kits
TOSS14-R	14-13/16"	2"	3"	36" base	4 kits
TOSS14S-R	14-13/16"	1-9/16"	3"	36" base	4 kits

Kit includes 2 trays, 4 hinges & installation screws

Individual Items

	Width	Depth	Height	Ctn Qty
TOSS11-REPL	11-11/16"	2"	3"	1 tray
TOSS11S-REPL	11-11/16"	1-9/16"	3"	1 tray
TOSS14-REPL	14-13/16"	2"	3"	1 tray
TOSS14S-REPL	14-13/16"	1-9/16"	3"	1 tray
TIPOUT-HINGE	-	-	-	1 pair

Drawer Organizers: White Tipout Tray:

Cabinet
Organizers

Perfect for storing sponges, scrubbers, and other small sink accessories



Convert false front drawers into useful hidden storage space
 Sold as kits or individual trays and hinge pairs
 Each kit includes 2 trays, 4 hinges, and screws
 White polymer plastic is durable and easily cleaned
 Ships with all necessary hinges and screws
 Hinges are self closing and feature adjustable opening angle
 1-9/16" slim depth trays are great for use in low clearance applications behind large sinks
 Compatible with NorthPoint Cabinetry® and all other cabinetry meeting the minimum size requirements



Kits	Width	Depth	Height	Standard Cabinet Size	Ctn Qty
TO11-R	11-11/16"	2"	3"	36" base	4 kits
TO11S-R	11-11/16"	1-9/16"	3"	36" base	4 kits
TO14-R	14-13/16"	2"	3"	36" base	4 kits
TO14S-R	14-13/16"	1-9/16"	3"	36" base	4 kits

Kit includes 2 trays, 4 hinges & installation screws

Individual Items

	Width	Depth	Height	Ctn Qty
TO11-REPL	11-11/16"	2"	3"	1 tray
TO11S-REPL	11-11/16"	1-9/16"	3"	1 tray
TO14-REPL	14-13/16"	2"	3"	1 tray
TO14S-REPL	14-13/16"	1-9/16"	3"	1 tray
TIPOUT-HINGE	-	-	-	1 pair

WALL ORGANIZATION



"No Wiggle" Wall Cabinet Pullout
Page 402

Wall Cabinet Organization

Maximize cabinet storage with Hardware Resources' wall cabinet organizers. From cabinet pullouts and bakeware organizers to spice racks and wine accessories, we can help you make the most beautiful and organized kitchen.

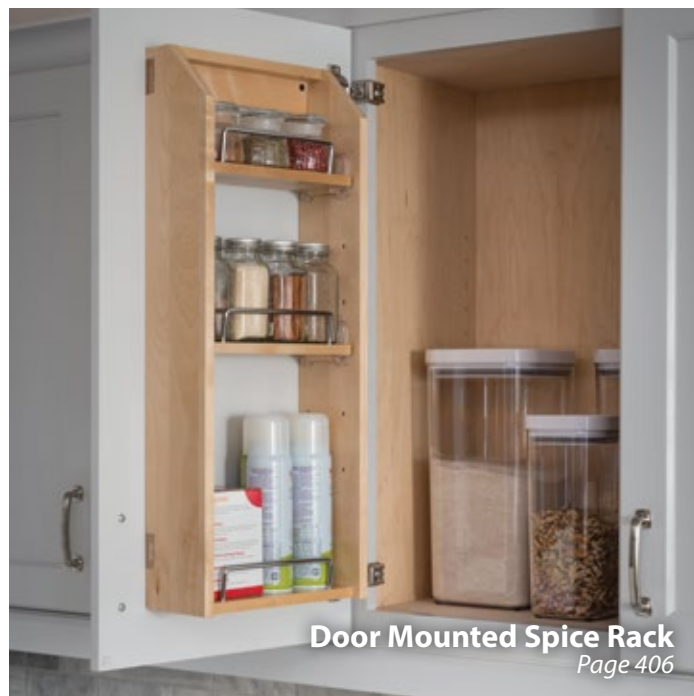
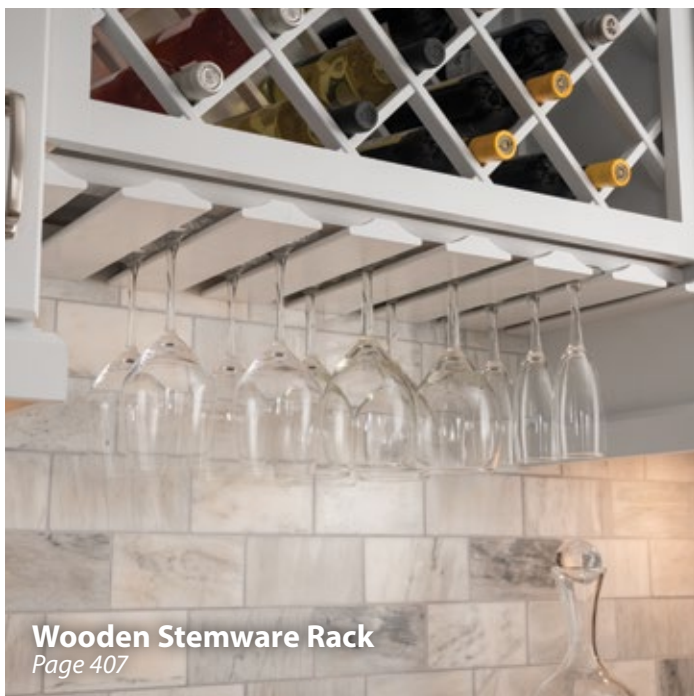

Wall Cabinet Organization: "No Wiggle" Wall Pullout

Organize spice jars and canisters in upper cabinets securely, even when the pullout is in motion



9,661,924 & 9,723,922
10,028,581 & 10,251,480



- Built on our "No Wiggle" platform
- Patented top mounting bracket eliminates excessive side-to-side movement and sag
- Bottom slides are concealed heavy-duty slides with soft-close mechanism
- Patented integrated 6-way adjustable door-mounting brackets allow for easy mounting of door
- Two adjustable shelves (26" height) and three adjustable shelves (32" height) included
- Frameless Friendly! Works in both face frame and frameless applications
- Ships fully assembled making installation a breeze
- Compatible with NorthPoint Cabinetry® and all other cabinetry meeting the minimum size requirements

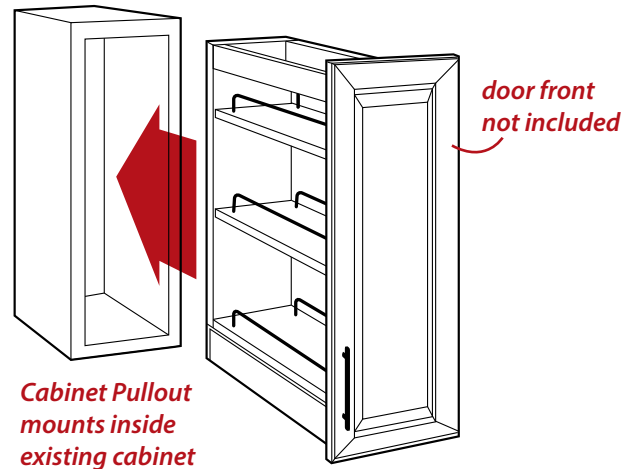
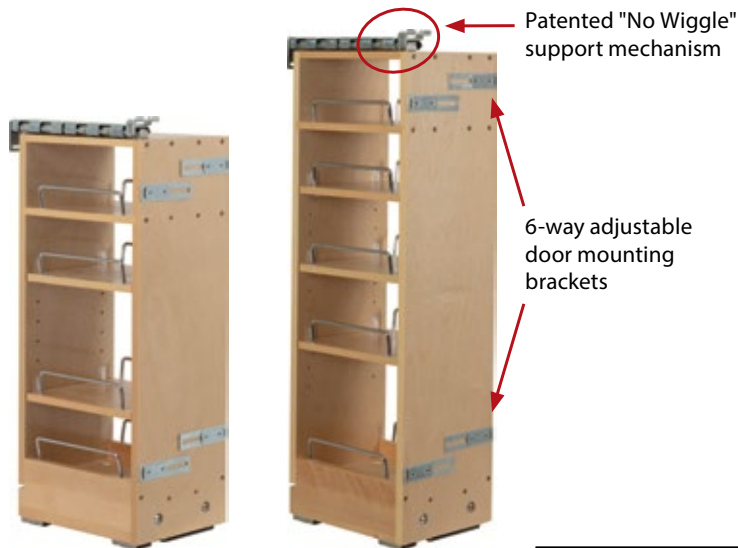

WPO2-268SC

WPO2-328SC

	Width	Depth	Height	Min. Opening	Standard Cabinet Size	Weight Capacity	Ctn Qty
WPO2-265SC	5"	10-3/8"	26"	5-1/2"	9" wall	100 lb.	1
WPO2-268SC	8"	10-3/8"	26"	8-1/2"	12" wall	100 lb.	1
WPO2-325SC	5"	10-3/8"	32"	5-1/2"	9" wall	100 lb.	1
WPO2-328SC	8"	10-3/8"	32"	8-1/2"	12" wall	100 lb.	1



Scan to watch the installation video
<https://delivr.com/2zu57>

Recommended screw:

#8 flat head

Wall Cabinet Organization: Wall Filler Pullout

Make functional storage from spaces as small as 3" wide in upper cabinet runs

- Used in 3" and 6" wide wall cabinet applications
- Installs in dead space between wall cabinets
- Two adjustable middle shelves
- Solid birch and birch plywood construction with clear UV finish
- Featuring 303FU Series full-extension 100 lb. ball bearing slides
- Ships preassembled and quickly installs to adjacent wall cabinets using predrilled pilot holes



	Width	Depth	Height	Min. Opening	Weight Capacity	Ctn Qty
WFPO330	3"	11-1/8"	30"	3"	50 lb.	1
WFPO630	6"	11-1/8"	30"	6"	50 lb.	1
WFPO336	3"	11-1/8"	36"	3"	50 lb.	1
WFPO636	6"	11-1/8"	36"	6"	50 lb.	1
WFPO342	3"	11-1/8"	42"	3"	50 lb.	1
WFPO642	6"	11-1/8"	42"	6"	50 lb.	1

Recommended screw: #6 face frame



Extra Shelves & Rails

		Ctn Qty
WFPO3-ES	Extra shelf for 3" WFPO	1
WFPO6-ES	Extra shelf for 6" WFPO	1
RAIL-7-PC	Extra rail for WFPO series	50

Wall Filler Pullout shown mounted between 2 cabinets

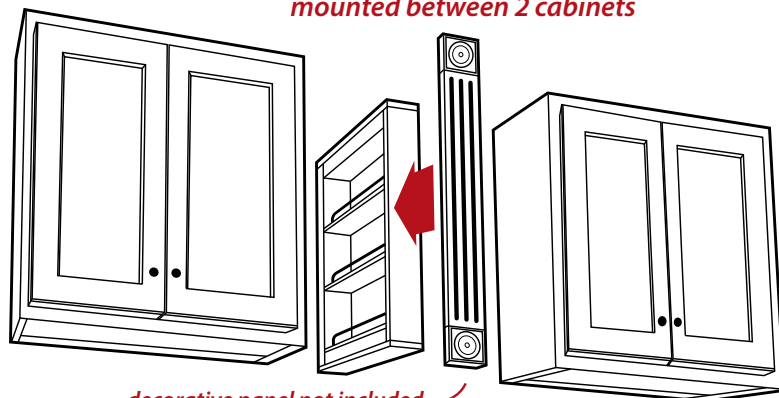

decorative panel not included

See the Hardware Resources Wood Products catalog or www.HardwareResources.com for more information.

Wall Cabinet Organization: Wire Tray Divider

Create vertical storage for trays and bakeware with these no-frills wire dividers



Easily and quickly installs with four screws (included)

Completely versatile organization – use multiple tray dividers and mix and match sizes to customize your storage

Place multiple dividers at any spacing – narrow for baking sheets and wider for cutting boards and baking dishes

Polished Chrome finish

Sold individually

Compatible with NorthPoint Cabinetry® and all other cabinetry meeting the minimum size requirements

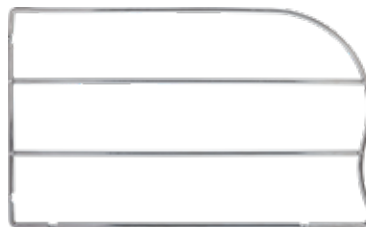

TD12-PC

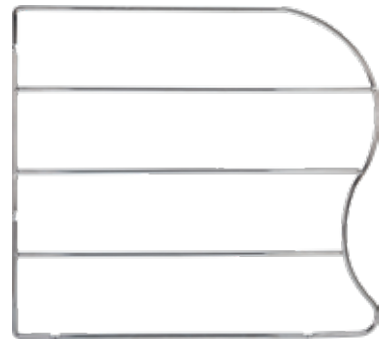

TD18-PC

	Width	Depth	Height	Standard Cab. Size	Ctn Qty
TD12-PC	1/4"	20"	12"	base or pantry	1
TD18-PC	1/4"	20"	18"	base or pantry	1



Mounts quickly to the cabinet floor and back wall with 4 screws

Wall Cabinet Organization: Wooden Tray Divider

Store bakeware, platters, and trays with this elegant wooden divider

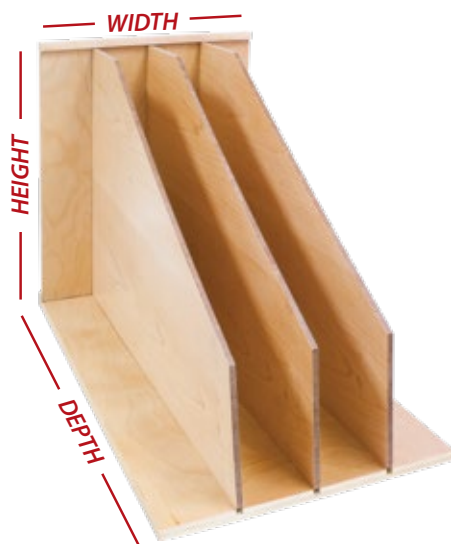

For 24" depth and 12" width cabinets (can be trimmed to smaller width)

Three removable dividers insert to allow 4 separate storage units with 2-3/4" interior storage width

Solid birch and birch plywood construction with clear UV finish

Ships flat pack

Easy to assemble

Compatible with NorthPoint Cabinetry® and all other cabinetry meeting the minimum size requirements



	Width	Depth	Height	Standard Cab. Size	Ctn Qty
TD3	11-3/4"	22-1/4"	16"	15" base or pantry	5

Recommended screw: #8 flat head

Wall Cabinet Organization: Door Mounted Spice Racks

Installs to back of cabinet door and holds a wide variety of spice jars, containers, and bottles



Door Mount Spice Rack with Adjustable Shelves

Ships with two support rails (22-3/8", 25-3/8", or 28-3/8" wide) which can be cut to size and allow installation to door stile

Three shelves: lower shelf is fixed, and two upper shelves are adjustable

Solid birch and birch plywood construction with clear UV finish

Compatible with NorthPoint Cabinetry® and all other cabinetry meeting the minimum size requirements



	Width	Depth	Height	Min. Opening	Standard Cab. Size	Ctn Qty
SPR9A	9-1/2"	4"	24"	12"	15" wall or base	5
SPR12A	12-1/2"	4"	24"	15"	18" wall or base	5
SPR15A	15-1/2"	4"	24"	18"	21" wall or base	5

Recommended screw:

#8 pan head

Extra Rails

	Length	Height	Ctn Qty	Use with HR Part #
RAIL-9-PC	9-1/4"	1-3/4"	50	SPR12A
RAIL-12-PC	12-1/4"	1-3/4"	50	SPR15A

Wall Cabinet Organization: Wooden Stemware Rack



Wooden Stemware Rack

- Used in 18", 30", or 36" wide spaces to hold 4, 7, or 8 rows of glasses
- For 12" deep cabinets (width and depth can be trimmed to fit smaller applications)
- Solid wood is sanded and can be finished to match the application
- Quickly installs using #6 x 1" pan head screws (provided)

	Species	Rows	Width	Depth	Height	Ctn Qty
SR18	Maple	4	18"	12"	1-1/2"	5
SR30	Maple	7	30"	12"	1-1/2"	5
SR36	Maple	8	36"	12"	1-1/2"	5



36" Wooden Stemware Rack

Build your own stemware rack

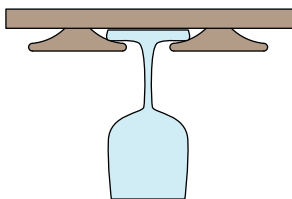

Wooden Stemware Moulding

- Cut to any length
- Priced by the linear foot, sold in 8' lengths

	Species	Width	Depth	Ctn Qty
STMW-ALD	Alder	3-3/16"	3/4"	40 LF
STMW-HMP	Hard Maple	3-3/16"	3/4"	40 LF

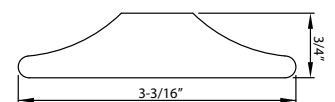

Wall Cabinet Organization: Wooden Wine Bottle Lattice

Create wine bottle storage with these trimmable lattice racks

Can be cut to size
Beveled mouldings with routed face
Mouldings are 5/8" thick x 3/4" wide
3-3/4" x 3-3/4" bottle openings
Solid wood is sanded and can be
finished to match the application
Sold by the piece

	<i>Species</i>	<i>Width</i>	<i>Height</i>	<i>Ctn Qty</i>
WR30-2ALD	Alder	24"	30"	10
WR30-2MP	Maple	24"	30"	10
WR30-2OK	Oak	24"	30"	10
WR45-2ALD	Alder	25"	45"	10
WR45-2MP	Maple	25"	45"	10
WR45-2OK	Oak	25"	45"	10
WR48-2ALD	Alder	36"	48"	10
WR48-2MP	Maple	36"	48"	10
WR48-2OK	Oak	36"	48"	10

Recommended screw: #6 flat head

Can be cut to size
Mouldings are 3/4" thick x 7/16" wide
4" x 4" bottle openings
Solid maple is sanded and can be
finished to match the application
Sold by the piece

	<i>Species</i>	<i>Width</i>	<i>Height</i>	<i>Ctn Qty</i>
WR30MP	Maple	24"	30"	10
WR36MP	Maple	36"	36"	10

Recommended screw: #6 flat head

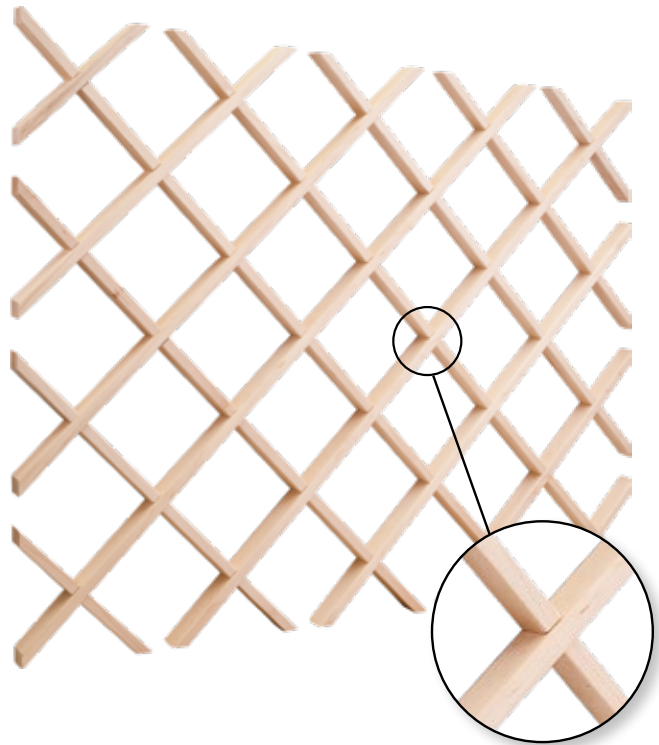
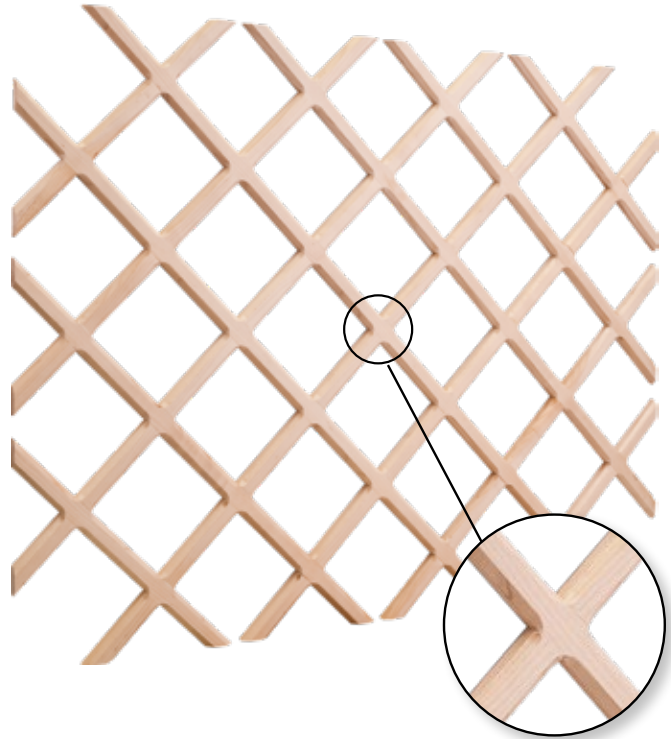

Wall Cabinet Organization: Wooden Bottle Rack & Wire Stemware

Wire Stemware Rack

- Thick wire gauge construction
- Under-cabinet mount with hidden installation holes
- Screws not included

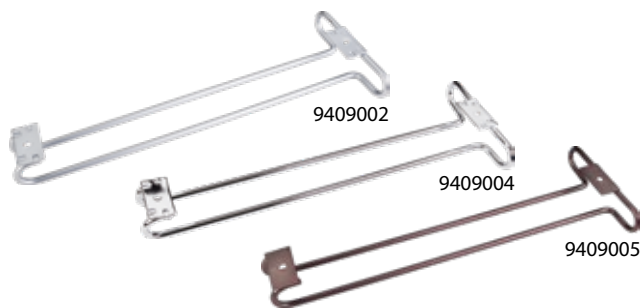

	Finish	Front Width	Rear Width	Length	Ctn Qty
9409002	Satin Chrome	4"	1-3/8"	11-7/16"	100
9409004	Polished Chrome	4"	1-3/8"	11-7/16"	100
9409005	Brushed Oil Rubbed Bronze	4"	1-3/8"	11-7/16"	100

Recommended screw: #6 flat head



	Species	# Bottles	Width	Depth	Height	Ctn Qty
BR24	Maple	5	24"	3/4"	2"	20
BR30	Maple	6	30"	3/4"	2"	20
BR48	Maple	10	48"	3/4"	2"	20

Recommended screw: #8 flat head



Wooden Bottle Rack

- Use in 24", 30", or 48" wide spaces to hold 5, 6, or 10 bottles
- Can also be trimmed to fit into 18" minimum spaces
- Install to base of cabinet or multiple units can be stacked
- Solid wood is sanded and can be finished to match the application
- Ships with front and back rails
- Screws not included

STORAGE with STYLE®

Storage solutions that beautifully coordinate to create a harmonious kitchen design

..... Drawer Base Pullout

..... Blind Corner Pullout

..... Trash Can Pullout

Storage with Style® is a designer organizer collection that beautifully coordinates to create a harmonious kitchen design. Add storage solutions to your kitchen with a trash can pullout, spice pullout, utensil pullout, pot and lid organizer, and pullout basket; all designed to coordinate for a cohesive look and to eliminate the need to reach inside a cabinet.

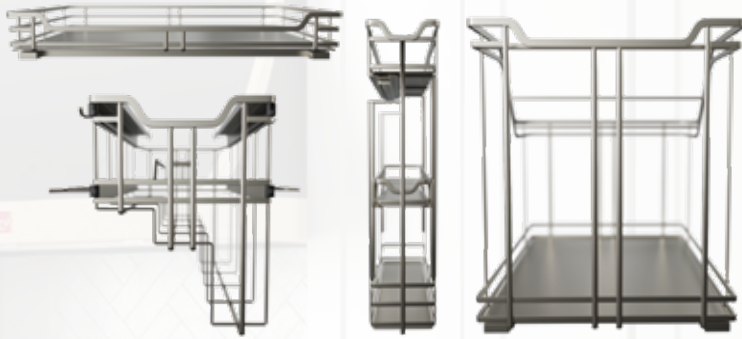

Design is in the details

Curved flat wire design details flow across all organizers to create a cohesive collection identity.



Stylish finish options

Designer finishes of Black Nickel and Polished Chrome coordinate with popular hardware styles. Mix finishes to add variety.



Base Pullout

Pot & Lid Organizer

Pullout Basket



Blind Corner Pullout

All four baskets slide and pull out of the corner cabinet opening for full access

Metal baskets are adjustable in height

Universal design for left or right-hand blind corners

Available in standard and full-height blind corner cabinets.
For full-height option, additional baskets can be added to make a three-tiered organizer (see at right)

Includes heavy-duty soft-close slides for smooth movement in and out of the cabinet (preinstalled)

Heavy-duty frame construction ensures organizer is stable when in motion

Acrylic liners add stability to baskets and are easy to clean

Compatible with NorthPoint Cabinetry® and all other cabinetry meeting the minimum size requirements





Black Nickel

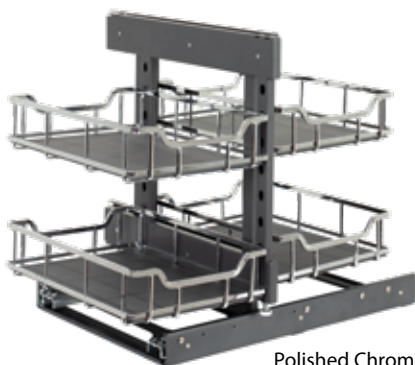

Polished Chrome

Description	Item Number	Frame Color	Width	Depth	Height	Standard Cabinet Size	Weight Capacity	Ctn Qty
Blind Corner Organizer for Standard-Height 15" Opening	SWS-BCS15BN	Black Nickel	26-13/16"	22-1/8"	20-9/16"	Blind Corner with drawer	130 lb.	1
	SWS-BCS15PC	Polished Chrome	26-13/16"	22-1/8"	20-9/16"	Blind Corner with drawer	130 lb.	1
Blind Corner Organizer for Standard-Height 18" Opening	SWS-BCS18BN	Black Nickel	32-7/8"	22-1/8"	20-9/16"	Blind Corner with drawer	130 lb.	1
	SWS-BCS18PC	Polished Chrome	32-7/8"	22-1/8"	20-9/16"	Blind Corner with drawer	130 lb.	1
Blind Corner Organizer for Full-Height 15" Opening*	SWS-BCFH15BN	Black Nickel	26-13/16"	22-1/8"	24-1/16"	Blind Corner - full-height door	130 lb.	1
	SWS-BCFH15PC	Polished Chrome	26-13/16"	22-1/8"	24-1/16"	Blind Corner - full-height door	130 lb.	1
Blind Corner Organizer for Full-Height 18" Opening*	SWS-BCFH18BN	Black Nickel	32-7/8"	22-1/8"	24-1/16"	Blind Corner - full-height door	130 lb.	1
	SWS-BCFH18PC	Polished Chrome	32-7/8"	22-1/8"	24-1/16"	Blind Corner - full-height door	130 lb.	1
Pair of Extra Baskets for SWS-BCFH15 15" Opening	SWS-BCBAS15BN	Black Nickel	12-3/16"	15-9/16"	3-9/16"	-	25 lb.	1
	SWS-BCBAS15PC	Polished Chrome	12-3/16"	15-9/16"	3-9/16"	-	25 lb.	1
Pair of Extra Baskets for SWS-BCFH18 18" Opening	SWS-BCBAS18BN	Black Nickel	15-3/16"	15-9/16"	3-9/16"	-	25 lb.	1
	SWS-BCBAS18PC	Polished Chrome	15-3/16"	15-9/16"	3-9/16"	-	25 lb.	1

Screws included

*Full-height door required

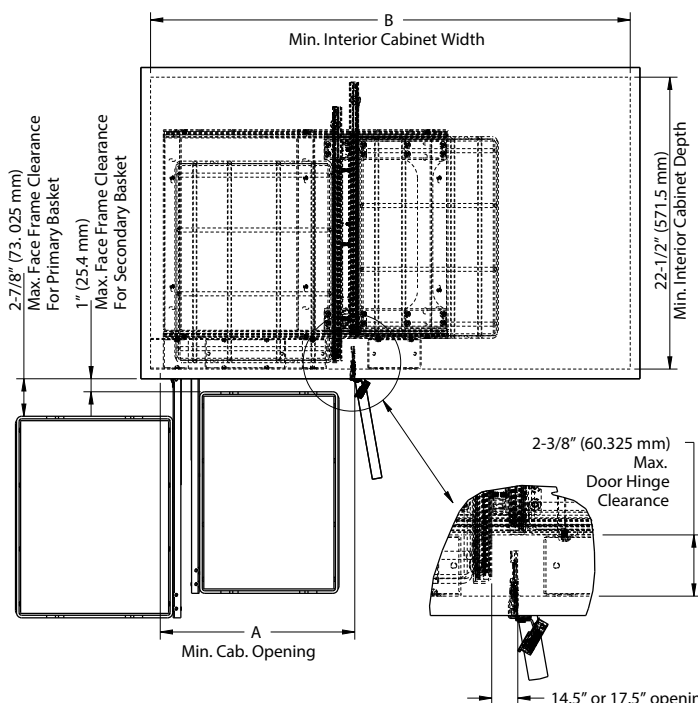

14.5" or 17.5" openings require a compact hinge and will have 1/2" hinge clearance

15" or 18" openings will have a 1" hinge clearance for long-arm hinges

Door Opening

	Height	A	B
SWS-BCS15BN	20-9/16"	14-1/2"	27"
SWS-BCS15PC	20-9/16"	14-1/2"	27"
SWS-BCS18BN	20-9/16"	17-1/2"	33"
SWS-BCS18PC	20-9/16"	17-1/2"	33"
SWS-BCFH15BN	24-1/16"	14-1/2"	27"
SWS-BCFH15PC	24-1/16"	14-1/2"	27"
SWS-BCFH18BN	24-1/16"	17-1/2"	33"
SWS-BCFH18PC	24-1/16"	17-1/2"	33"



Scan to watch the installation video

<https://delivr.com/2xyyp>



Base Pullout

Integrated, patented 6-way adjustable door mounting brackets

"No Wiggle" patented hardware eliminates excessive sag and side-to-side movement

Smooth, soft-close slides (preinstalled)

Middle shelf is adjustable

Removable grey acrylic liners for easy cleaning

Ships fully assembled and ready to install

Requires full-height cabinet door

Compatible with NorthPoint Cabinetry® and all other cabinetry meeting the minimum size requirements



PATENT
9,723,922



Polished Chrome



Black Nickel

	Description	Frame Color	Width	Depth	Height	Min. Opening	Standard Cab. Size	Weight Capacity	Ctn Qty
SWS-BPO5BN	5" Wire Base Pullout	Black Nickel	5-15/16"	21-5/16"	24-1/16"	6"	9" full-height base	100 lb.	1
SWS-BPO5PC	5" Wire Base Pullout	Polished Chrome	5-15/16"	21-5/16"	24-1/16"	6"	9" full-height base	100 lb.	1
SWS-BPO8BN	8" Wire Base Pullout	Black Nickel	8-15/16"	21-5/16"	24-1/16"	9"	12" full-height base	100 lb.	1
SWS-BPO8PC	8" Wire Base Pullout	Polished Chrome	8-15/16"	21-5/16"	24-1/16"	9"	12" full-height base	100 lb.	1

Screws included

STORAGE with STYLE®



Scan to watch the installation video
<https://delivr.com/2eyqn>

Drawer Base Pullout

- Reduced height to use in a standard cabinet under a drawer.
- Integrated, patented 6-way adjustable door mounting brackets
- "No Wiggle" patented hardware eliminates excessive sag and side-to-side movement
- Smooth, soft-close slides (preinstalled)
- One adjustable shelf included
- Removable grey acrylic liners for easy cleaning
- Ships fully assembled and ready to install
- Compatible with NorthPoint Cabinetry® and all other cabinetry meeting the minimum size requirements

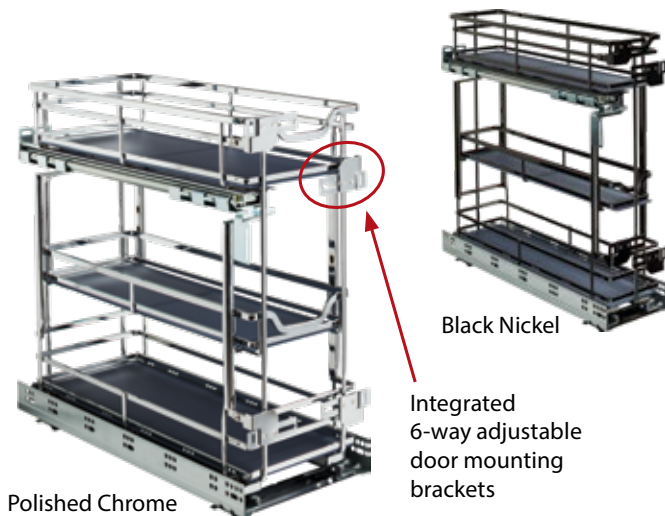

Polished Chrome

Black Nickel

Integrated 6-way adjustable door mounting brackets

	Description	Frame Color	Width	Depth	Height	Min. Opening	Standard Cab. Size	Weight Capacity	Ctn Qty
SWS-DBPO5BN	5" Wire Drawer Base Pullout	Black Nickel	5-15/16"	21-5/16"	20-1/4"	5"	9" base	100 lb.	1
SWS-DBPO5PC	5" Wire Drawer Base Pullout	Polished Chrome	5-15/16"	21-5/16"	20-1/4"	5"	9" base	100 lb.	1
SWS-DBPO8BN	8" Wire Drawer Base Pullout	Black Nickel	8-15/16"	21-5/16"	20-1/4"	9"	12" base	100 lb.	1
SWS-DBPO8PC	8" Wire Drawer Base Pullout	Polished Chrome	8-15/16"	21-5/16"	20-1/4"	9"	12" base	100 lb.	1

Screws included



SHIPS FULLY ASSEMBLED



Scan to watch the installation video
<https://delivr.com/2eyqn>

Utensil Base Pullout

- Convenient storage for kitchen utensils
- Includes 4 stainless steel bins that are easy to remove for cleaning
- Open bottom shelf for additional storage
- Integrated, patented 6-way adjustable door mounting brackets
- "No Wiggle" patented hardware eliminates excessive sag and side-to-side movement
- 100 lb. full extension soft close slides
- Smooth, soft-close slides (preinstalled)
- Removable grey acrylic liners for easy cleaning
- Ships fully assembled and ready to install
- Compatible with NorthPoint Cabinetry® and all other cabinetry meeting the minimum size requirements



PATENT
9,723,922

Optional 6-way adjustable door mounting brackets included



Polished Chrome



Black Nickel



Replacement canisters available
UCSS-46

	Description	Frame Color	Width	Depth	Height	Min. Opening	Standard Cab. Size	Weight Capacity	Ctn Qty
SWS-UBPO8BN	8" Wire Base Pullout	Black Nickel	8-15/16"	21-5/16"	24-1/16"	8-1/2"	12" full-height base	100 lb.	1
SWS-UBPO8PC	8" Wire Base Pullout	Polished Chrome	8-15/16"	21-5/16"	24-1/16"	8-1/2"	12" full-height base	100 lb.	1

Screws included

STORAGE with STYLE[®]



 **SHIPS FULLY
ASSEMBLED**



**Scan to watch the
installation video**
<http://delivr.com/23y5t>

Pot & Lid Organizer Pullout

Designed to prevent pans from banging together, keeping them from being damaged and preventing unwanted noise

Top mounting, leaves bottom of the cabinet accessible for additional storage

Hooks are adjustable for full customization

Integrated lid storage

Smooth, soft-close slides

Ships fully assembled and installs with just four screws

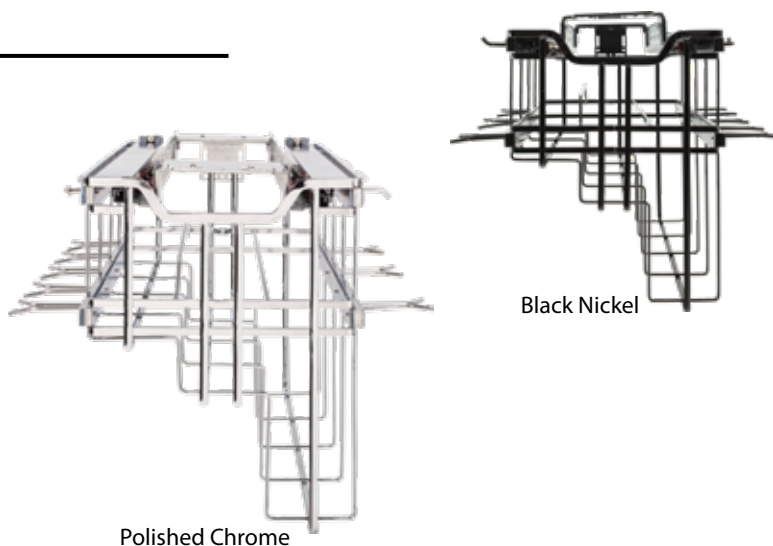

Polished Chrome

Black Nickel

	<i>Frame Color</i>	<i>Width</i>	<i>Depth</i>	<i>Height</i>	<i>Min. Opening</i>	<i>Standard Cab. Size</i>	<i>Weight Capacity</i>	<i>Ctn Qty</i>
SWS-PO21BN	Black Nickel	15-5/8"	22-5/8"	13-7/16"	15-5/8"	24" base	100 lb.	1
SWS-PO21PC	Polished Chrome	15-5/8"	22-5/8"	13-7/16"	15-5/8"	24" base	100 lb.	1

Screws included



Scan to watch the installation video
<http://delivr.com/2cjgh>

SHIPS FULLY ASSEMBLED

Trash Can Pullout

Ships fully assembled with trash can(s) available in 3 configurations: double can 35 qt., double can 50 qt., and single can 35 qt.

Integrated, patented 6-way adjustable door mounting brackets

Smooth, soft-close slides (preinstalled)

Removable grey acrylic liners for easy cleaning

Installs with just four screws

Compatible with NorthPoint Cabinetry® and all other cabinetry meeting the minimum size requirements



PATENT
 9,723,922
 & D876,094

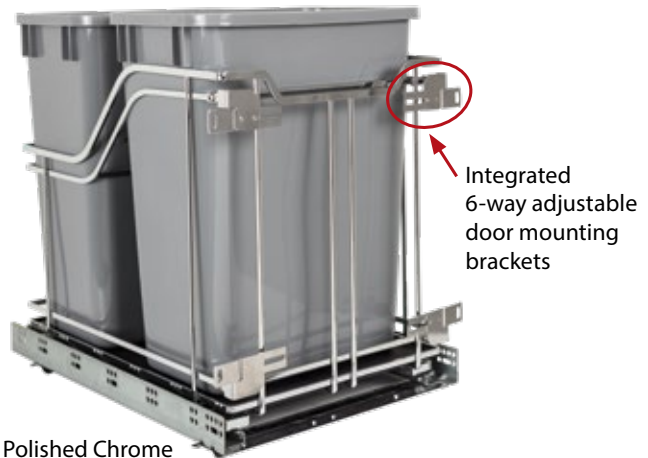

Polished Chrome

	Description	Frame Color	Can Color	Width	Depth	Height	Min. Opening	Standard Cab. Size	Weight Capacity	Ctn Qty
SWS-MBMS35GBN	Single 35 qt.	Black Nickel	Grey	12"	21-13/16"	20"	12"	15" base	100 lb.	1
SWS-MBMS35GPC	Single 35 qt.	Polished Chrome	Grey	12"	21-13/16"	20"	12"	15" base	100 lb.	1
SWS-MBMD35GBN	Double 35 qt.	Black Nickel	Grey	14-15/16"	21-13/16"	20"	15"	18" base	100 lb.	1
SWS-MBMD35GPC	Double 35 qt.	Polished Chrome	Grey	14-15/16"	21-13/16"	20"	15"	18" base	100 lb.	1
SWS-MBMD50GBN	Double 50 qt.	Black Nickel	Grey	14-15/16"	21-13/16"	24"	15"	18" full-height base	100 lb.	1
SWS-MBMD50GPC	Double 50 qt.	Polished Chrome	Grey	14-15/16"	21-13/16"	24"	15"	18" full-height base	100 lb.	1

Screws included

STORAGE with STYLE®

Pullout Basket & Pilaster System

- Can be bottom mounted or side-mounted for face frame or frameless application
- Stack multiple baskets with optional pilaster system
- Smooth, soft-close slides
- Sleek, modern metal design
- Available in two finishes: Polished Chrome & Black Nickel
- Removable grey acrylic liners for easy cleaning
- Compatible with NorthPoint Cabinetry® and all other cabinetry meeting the minimum size requirements



PATENT
9,723,922



SWS-WB273BN
Black Nickel



SWS-WB213PC
Polished Chrome



Scan to watch the
installation video
<https://delivr.com/2eyqn>

	Description	Frame Color	Width	Depth	Height	Min. Opening	Standard Cab. Size	Weight Capacity	Ctn Qty
SWS-WB153BN	Wire Pullout Basket	Black Nickel	14-1/2"	22-1/16"	4-1/4"	14-1/2"	18" base	100 lb.	1
SWS-WB153PC	Wire Pullout Basket	Polished Chrome	14-1/2"	22-1/16"	4-1/4"	14-1/2"	18" base	100 lb.	1
SWS-WB213BN	Wire Pullout Basket	Black Nickel	20-7/16"	22-1/16"	5-7/16"	20-1/2"	24" base	100 lb.	1
SWS-WB213PC	Wire Pullout Basket	Polished Chrome	20-7/16"	22-1/16"	5-7/16"	20-1/2"	24" base	100 lb.	1
SWS-WB273BN	Wire Pullout Basket	Black Nickel	26-5/16"	22-1/16"	5-7/16"	26-1/2"	30" base	100 lb.	1
SWS-WB273PC	Wire Pullout Basket	Polished Chrome	26-5/16"	22-1/16"	5-7/16"	26-1/2"	30" base	100 lb.	1
SWS-PILKITBN	Pilaster System	Black Nickel	1-1/4"	8/16"	21-1/2"	-	-	-	1
SWS-PILKITPC	Pilaster System	Polished Chrome	1-1/4"	8/16"	21-1/2"	-	-	-	1

Screws included

Easy-to-install
CABINET ORGANIZERS

Organize Your Kitchen in
11 minutes
or less



All you need:



Measuring Tape



Phillips Screwdriver



Pencil (optional)



11 Minutes!

It's That Easy!



1

Measure

Measure your cabinet's interior width, depth, and height. Hold your tape parallel to the cabinet's walls. Note any pipes, shelves, or hinges that may affect actual available space.

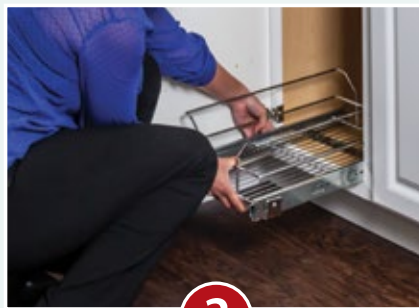

2

Set

Set your organizer in place making sure you can open and close the cabinet door easily. If the organizer installs on the cabinet door, consider marking two points to help with alignment.

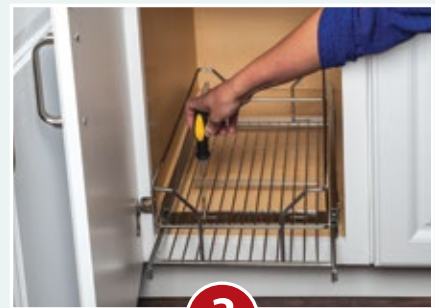

3

Secure

Using your Phillips screwdriver and the screws provided, secure your organizer in place.

Retail Packaged

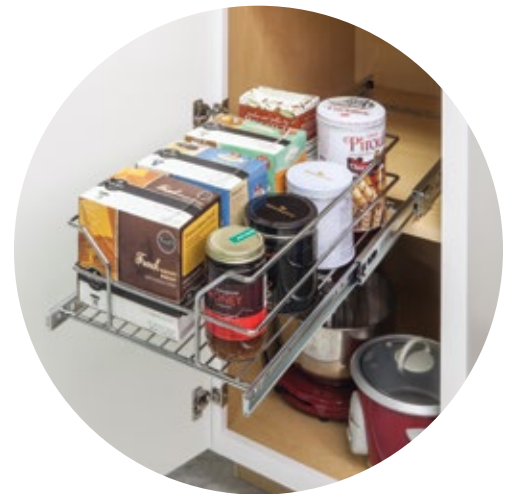

Scan to watch the installation video
<https://delivr.com/2h7bh>



Installation Screws Included

Great for organizing your cookware or pantry
 Full-extension ball bearing slides
 Heavy-duty wire construction
 Quickly mounts to cabinet floor or fixed shelf using four screws (included)

Compatible with NorthPoint Cabinetry® and all other cabinetry meeting the minimum size requirements

	Description	Finish	Width	Depth	Height	Min. Opening	Fits Standard Cabinet Size	Weight Capacity	Ctn Qty
MBPO15-R	Pullout Basket	Polished Chrome	11-3/8"	19-11/16"	6-3/16"	11-1/2"	15" base	50 lb.	3
MBPO18-R	Pullout Basket	Polished Chrome	14-3/8"	19-11/16"	6-3/16"	14-1/2"	18" base	50 lb.	3
MBPO21-R	Pullout Basket	Polished Chrome	17-3/8"	19-11/16"	6-3/16"	17-1/2"	21" base	50 lb.	3

Trash Can Pullout

Organize Your Kitchen in **11 minutes** or less



Retail Packaged



Cans Sold Separately



Scan to watch the installation video
<https://delivr.com/267m4>



Use optional door mounting kit for door pullout application

- Heavy-duty 100 lb. full-extension ball bearing slides
- Thick wire frame construction
- Durable polymer plastic trash cans are easily cleaned
- Cans and lids sold separately (see page 328)
- Quickly mounts to cabinet floor using four screws (included)
- Wire handle included

- Optional 6-way adjustable door mounting kit for door pullout application
- Retail packed with English, French, and Spanish translations
- Compatible with NorthPoint Cabinetry® and all other cabinetry meeting the minimum size requirements
- Note:** Double 50 qt. unit requires full-height cabinet

	Description	Finish	Width	Depth	Height	Min. Opening	Standard Cabinet Size	Weight Capacity	Ctn Qty
CAN-EBMSB-R	Single Can 35 or 50 qt.	Black	10-1/4"	22-1/16"	13"	10-1/4"	15" base	50 lb.	6
CAN-EBMSPC-R	Single Can 35 or 50 qt.	Polished Chrome	10-1/4"	22-1/16"	13"	10-1/4"	15" base	50 lb.	6
CAN-EBMSW-R	Single Can 35 or 50 qt.	White	10-1/4"	22-1/16"	13"	10-1/4"	15" base	50 lb.	6
CAN-EBMDB-R	Double Can 35 qt. only	Black	13-15/16"	22"	13"	13-15/16"	18" base	50 lb.	4
CAN-EBMDPC-R	Double Can 35 qt. only	Polished Chrome	13-15/16"	22"	13"	13-15/16"	18" base	50 lb.	4
CAN-EBMDW-R	Double Can 35 qt. only	White	13-15/16"	22"	13"	13-15/16"	18" base	50 lb.	4
CAN-EBMD50B-R	Double Can 50 qt. only	Black	15-3/16"	22-1/16"	12-13/16"	15-3/16"	18" full-height base	50 lb.	4
CAN-EBMD50PC-R	Double Can 50 qt. only	Polished Chrome	15-3/16"	22-1/16"	12-13/16"	15-3/16"	18" full-height base	50 lb.	4
CAN-EBMD50W-R	Double Can 50 qt. only	White	15-3/16"	22-1/16"	12-13/16"	15-3/16"	18" full-height base	50 lb.	4
CAN-DOORKIT	Door Mounting Kit	Black	2-1/2"	5-1/4"	6-5/8"	-	-	-	20
CAN-DOORKITPC	Door Mounting Kit	Polished Chrome	2-1/2"	5-1/4"	6-5/8"	-	-	-	20
CAN-DOORKITW	Door Mounting Kit	White	2-1/2"	5-1/4"	6-5/8"	-	-	-	20

Retail Packaged

Cans available in 2 sizes and 3 standard colors – black, grey, & white

Lids available in 3 standard colors plus green for recycling

High quality polymer plastic material is durable and easy to clean

Compatible with any of our trash can pullouts



35 qt. cans

50 qt. cans

	Description	Can Color	Depth	Width	Height	Ctn Qty
CAN-35	35 qt. Plastic Can	Black	9-7/16"	14-1/2"	18"	10
CAN-35W	35 qt. Plastic Can	White	9-7/16"	14-1/2"	18"	10
CAN-35GRY	35 qt. Plastic Can	Grey	9-7/16"	14-1/2"	18"	10
CAN-35LID	Lid for 35 qt. Plastic Can	Black	9-3/8"	14-1/2"	1-5/8"	10
CAN-35LIDW	Lid for 35 qt. Plastic Can	White	9-3/8"	14-1/2"	1-5/8"	10
CAN-35LIDGRY	Lid for 35 qt. Plastic Can	Grey	9-3/8"	14-1/2"	1-5/8"	10
CAN-35LIDG	Lid for 35 qt. Plastic Can	Green	9-3/8"	14-1/2"	1-5/8"	10
CAN-50	50 qt. Plastic Can	Black	10-1/4"	14-7/8"	22-1/4"	10
CAN-50W	50 qt. Plastic Can	White	10-1/4"	14-7/8"	22-1/4"	10
CAN-50GRY	50 qt. Plastic Can	Grey	10-1/4"	14-7/8"	22-1/4"	10
CAN-50LID	Lid for 50 qt. Plastic Can	Black	10-1/4"	14-5/8"	1-5/8"	10
CAN-50LIDW	Lid for 50 qt. Plastic Can	White	10-1/4"	14-5/8"	1-5/8"	10
CAN-50LIDGRY	Lid for 50 qt. Plastic Can	Grey	10-1/4"	14-5/8"	1-5/8"	10
CAN-50LIDG	Lid for 50 qt. Plastic Can	Green	10-1/4"	14-5/8"	1-5/8"	10

Great for



Recycling



Cleaning Supply Caddy

Organize Your Kitchen in **11 minutes** or less



Retail Packaged



Scan to watch the installation video
<https://delivr.com/26zh9>



Ergonomic Plastic Handle



- Ergonomic plastic handle
- Removable caddy keeps cleaning supplies organized
- Holds a variety of bottles and boxes
- Mounts easily under your sink, left- or right-handed
- Simply pick it up and take it with you
- Plastic liner tray catches drips

- Full-extension ball bearing slides
- Heavy-duty wire construction
- 25 lb. capacity
- Quickly mounts to cabinet floor using four screws (included)
- Compatible with NorthPoint Cabinetry® and all other cabinetry meeting the minimum size requirements

	Description	Finish	Width	Depth	Height	Min. Opening	Fits Standard Cabinet Size	Weight Capacity	Ctn Qty
SCPO2-R	Cleaning Caddy Pullout	Polished Chrome	11-5/8"	19-11/16"	15-15/16"	11-5/8"	15" base	25 lb.	2

Retail Packaged

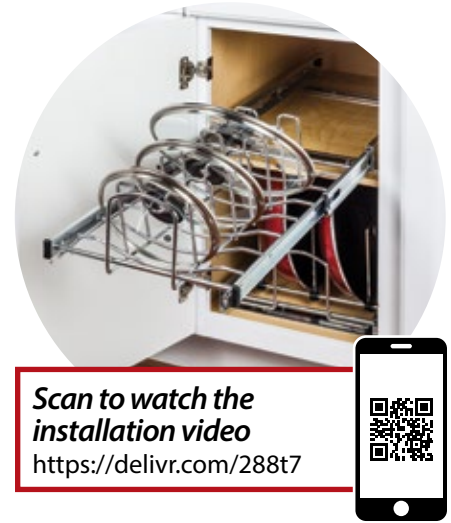

- Lid organizer holds 7 lids
- Pot organizer has adjustable dividers
- Pot organizer holds most cookware sizes and brands
- Full-extension ball bearing slides
- Heavy-duty wire construction

Quickly mounts to cabinet floor or fixed shelf using four screws (included)

Compatible with NorthPoint Cabinetry® and all other cabinetry meeting the minimum size requirements

	Description	Finish	Width	Depth	Height	Min. Opening	Fits Standard Cabinet Size	Weight Capacity	Ctn Qty
A	MPLO215-R Lid Organizer Pullout	Polished Chrome	11-3/8"	19-11/16"	5-3/8"	11-3/8"	15" base	100 lb.	3
B	MPPO215-R Pots Organizer Pullout	Polished Chrome	11-3/8"	19-11/16"	9"	11-3/8"	15" base	100 lb.	3

Door Mounted Tray System

Organize Your Kitchen in **11 minutes** or less



Retail Packaged



3" deep tray



Scan to watch the installation video
<https://delivr.com/282d6>



Scan to watch the installation video
<https://delivr.com/2dcuv>



6" deep tray

- Great for pantries or use it as a spice rack
- Mount in lower cabinet for cleaning supplies or trash bag storage
- Holds cans, jars, and packets
- Kit includes 2 pcs of 18" long track and 2 trays
- Extra trays sold separately

- Use multiple kits for oversize pantry doors
- Heavy-duty wire construction
- Quickly mounts to cabinet door using four screws (included)
- Compatible with NorthPoint Cabinetry® and all other cabinetry meeting the minimum size requirements

	Description	Finish	Width	Depth	Height	Min. Opening	Fits Standard Cabinet Size	Weight Capacity	Ctn Qty
A	DMS3-PC-R Door Mount Tray System 3"	Polished Chrome	11-9/16"	3-1/8"	18-1/8"	11-9/16"	15" base or wall	30 lb.	6
B	DMS6-PC-R Door Mount Tray System 6"	Polished Chrome	11-9/16"	5-15/16"	18-1/8"	11-9/16"	15" base or wall	30 lb.	4
C	DMT3-PC-R Individual 3" deep tray	Polished Chrome	11"	3-1/16"	2-7/8"	11"	-	-	20
D	DMT6-PC-R Individual 6" deep tray	Polished Chrome	11"	5-7/8"	3-7/16"	11"	-	-	20

Retail Packaged



360°
 rotating

- 360 degree revolving tray
- Great for organizing dry goods and cans
- Fits 24" diagonal wall corner cabinet
- Heavy-duty wire construction
- Quickly mounts to cabinet floor or fixed shelf using four screws (included)
- Compatible with NorthPoint Cabinetry® and all other cabinetry meeting the minimum size requirements

*Scan to watch the
 installation video*
<https://delivr.com/22s7a>



	Description	Finish	Diameter	Height	Fits Standard Cabinet Size	Weight Capacity	Ctn Qty
MLSR18-S-R	Single Shelf Lazy Susan	Polished Chrome	17-5/16"	3-13/16"	24" diagonal wall corner	30 lb.	1

3 Tier Spice Rack Pulldown

Organize Your Kitchen in **11 minutes** or less



Retail Packaged



- Great for organizing spices and small jars in your cabinets
- Remove clutter of small, hard to reach items
- Simple pull-down motion gives access to 3 tiers of organization
- Quickly mounts to cabinet floor or fixed shelf using four screws (included)
- Designed for 18" standard wall cabinets
- Compatible with NorthPoint Cabinetry® and all other cabinetry meeting the minimum size requirements



Scan to watch the installation video
<http://delivr.com/2jjwy>



Description	Finish	Width	Depth	Height	Min. Opening	Fits Standard Cabinet Size	Weight Capacity	Ctn Qty	
TTSPD-R	3-Tier Spice Pulldown	Polished Chrome	14-9/16"	10-9/16"	8-5/8"	14-9/16"	18" wall cabinet	20 lb.	1

Retail Packaged



Convert faux drawer panels to functional storage space

Kit includes two trays, four self-closing tipout hinges and installation screws

Tray is easily removable for cleaning

Slim design for use with large sinks

Compatible with NorthPoint Cabinetry® and all other cabinetry meeting the minimum size requirements

! Shown using 2 hinges. Kit includes 4 hinges for installation on 1 or 2 fronts.

See pages 398-399 for individually packaged hinges and trays

	<i>Finish</i>	<i>Width</i>	<i>Depth</i>	<i>Height</i>	<i>Ctn Qty</i>
TO11-R	White	11-11/16"	2"	3"	4 kits
TOSS11-R	Stainless Steel	11-11/16"	2"	3"	4 kits
TO11S-R	White	11-11/16"	1-9/16"	3"	4 kits
TOSS11S-R	Stainless Steel	11-11/16"	1-9/16"	3"	4 kits
TO14-R	White	14-13/16"	2"	3"	4 kits
TOSS14-R	Stainless Steel	14-13/16"	2"	3"	4 kits
TO14S-R	White	14-13/16"	1-9/16"	3"	4 kits
TOSS14S-R	Stainless Steel	14-13/16"	1-9/16"	3"	4 kits



Retail Packaged

Under Cabinet Stemware Rack

- Mounts under the cabinet
- Holds 3 glasses
- Coordinates with Wine Bottle Rack
- Heavy-duty wire construction
- Quickly mounts to cabinet with 2 screws (included)



	Finish	Width	Depth	Height	Ctn Qty
STEM1-DBAC-R	Brushed Oil Rubbed Bronze	4-1/16"	9-1/16"	1"	8
STEM1-PC-R	Polished Chrome	4-1/16"	9-1/16"	1"	8
STEM1-SN-R	Satin Nickel	4-1/16"	9-1/16"	1"	8

Under Cabinet Bottle Rack

- Mounts under the cabinet
- Holds 2 bottles
- Coordinates with Stemware Rack
- Heavy-duty wire construction
- Quickly mounts to cabinet with 4 screws (included)



	Finish	Width	Depth	Height	Ctn Qty
WBH-DBAC-R	Brushed Oil Rubbed Bronze	3-15/16"	9-5/16"	9-1/16"	3
WBH-PC-R	Polished Chrome	3-15/16"	9-5/16"	9-1/16"	3
WBH-SN-R	Satin Nickel	3-15/16"	9-5/16"	9-1/16"	3



Retail Packaged

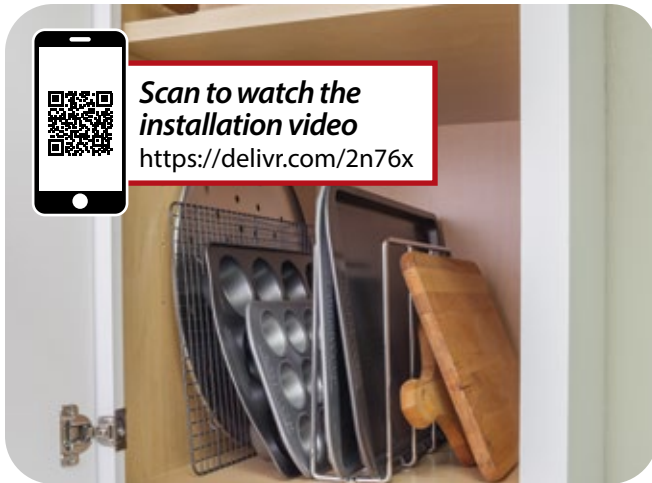

Scan to watch the
 installation video
<https://delivr.com/2n76x>

U-Shaped Tray Divider

Organize baking sheets, trays, and cutting boards
 Use multiple Tray Dividers to customize storage
 Heavy-duty wire construction
 Quickly mounts to cabinet bottom
 with 4 screws (included)



	Finish	Width	Depth	Height	Ctn Qty
TD-PC-R	Polished Chrome	3-7/16"	11-3/4"	9-15/16"	3



Scan to watch the
 installation video
<https://delivr.com/2d63p>

3-Tier Dishcloth Rack

Mounts to inside of cabinet door
 Holds 3 towels
 Heavy-duty wire construction
 Quickly mounts to cabinet door with 2 screws
 (included)



	Finish	Width	Depth	Height	Min. Opening	Ctn Qty
DTH-PC-R	Polished Chrome	12-3/4"	15/16"	6-1/16"	15"	8



Over the Door Towel Bar

Stainless Steel construction
 No screws required – simply hang
 it over the cabinet door
 Fits standard cabinet doors &
 drawers (5/8"–3/4" thick)
 Perfect for kitchens and bathrooms

	Finish	Width	Depth	Height	Ctn Qty
OTDTHSS-R	Stainless Steel	9-3/4"	2-3/8"	2-13/16"	1

BATHROOM ORGANIZATION



Bathroom Cabinet Organization

An organized bathroom is just as important as an organized kitchen. Getting ready for the day in an organized bathroom helps to eliminate stress and save time. These organizers help transform a bathroom from clutter to clarity.





1 POWERED VANITY DRAWER

Convert a vanity drawer into a hairstyling workstation where hair appliances can stay plugged in and ready to go when needed. Simply plug the drawer into an outlet behind the vanity for easy installation that doesn't require an electrician.

See pages 436–437 for full product offering.

2 VANITY DEPTH DRAWER INSERT

Drawer inserts aren't just for the kitchen. Organize a variety of beauty and grooming items in bathroom drawers with this clever insert that is adjustable and trimmable for a variety of drawer sizes.

See page 441 for full product offering.

May require trimming

Organization Is Not Just for the Kitchen

4



3 VANITY DEPTH WOOD BOTTOM MOUNT TRASH CAN

Tuck bathroom trash cans away from little hands or wandering noses with this pullout, designed for mounted-door or hinged-door applications.

See page 440 for full product offering.

4 "NO WIGGLE" VANITY PULLOUT

Bring "no wiggle" technology into the bathroom and tame clutter with a pullout designed with the bath in mind. With two optional inserts available, this product can be modified to suit a variety of needs.

See pages 438–439 for full product offering.



Bathroom Organization: Powered Vanity Drawer



Scan to watch the
installation video
<http://delivr.com/2n2b4>



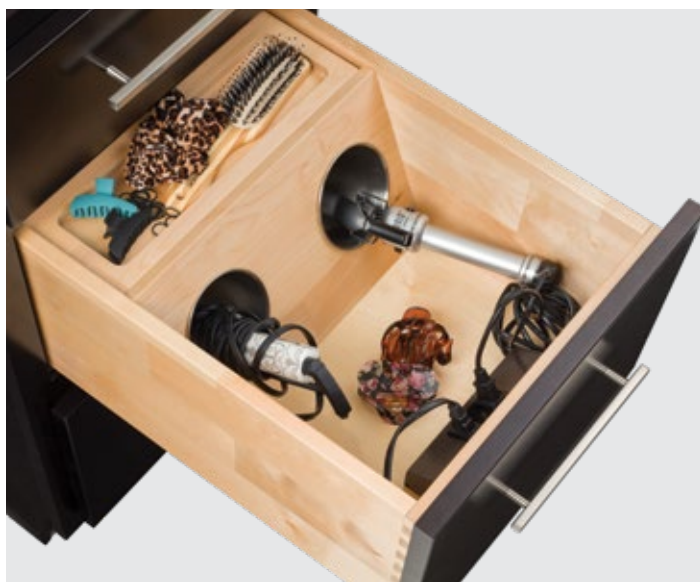

No Electrician Needed! Simply plug into an outlet behind the vanity for easy installation.

Convert a vanity drawer into a hair styling workstation with our Powered Vanity Drawer. This dovetail drawer is equipped with a powered two-plug receptacle. Hair appliances can stay plugged in and ready to go when they are needed. Add glamour and convenience to every bathroom suite with this powered vanity organizer.

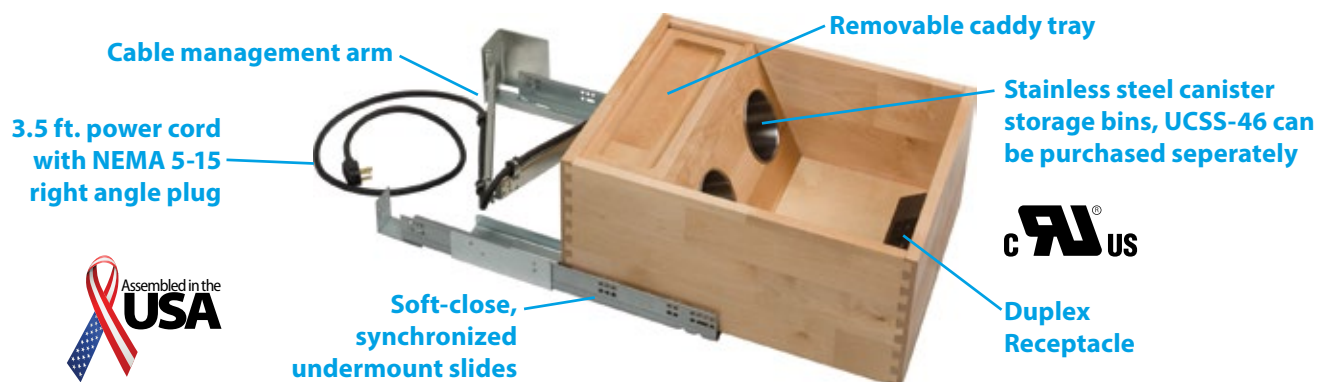

Easy plug and play installation**

UL Recognized to UL962/CSA C22.2 No. 0:20 | Patent Pending

- Max AC Current: 15 amps @ 120 VAC
- Automatic power shutoff when drawer is closed

**Install a 120v outlet within 3.5 feet of where the drawer will be installed (GFCI outlet is recommended).

Drawer comes fully assembled with slides and power cord management hardware attached and ready for installation

Patent Pending automatic switch cuts power when the drawer is closed to ensure safe storage of hot tools.

Two stainless steel canisters hold appliances, and an additional caddy on the top keeps all grooming items together

Designed to fit a 15" wide vanity drawer opening; fits NorthPoint Cabinetry® VB18-3 as a replacement drawer (see page 451 for reference guide)

US Patents pending

	Description	Width	Depth	Height*	Min. Opening	Standard Cabinet Size	Weight Capacity	Ctn Qty
PVGD15-SC	15" Powered Vanity Drawer	15"	19-23/32"	8-23/32"	15"	18" vanity base	100 lb.	1

Screws included

Bathroom Organization: "No Wiggle" Vanity Pullout

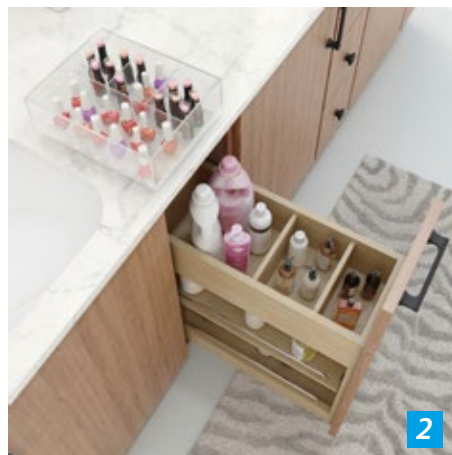
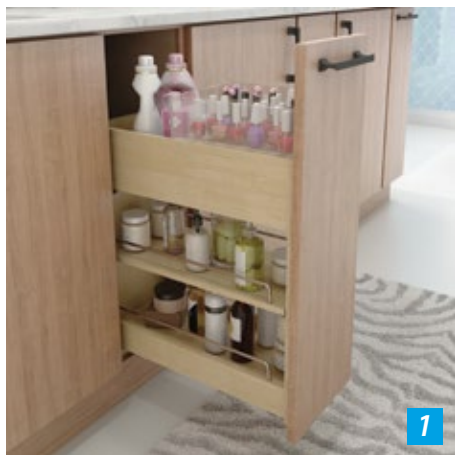

Tame Bath Clutter

Vanity base pullouts are great for narrow bathroom cabinets. Made of high quality wood and built on our superior "No Wiggle" platform, these pullouts are designed to keep clutter at bay. *See pages 332 & 333 for details about "No Wiggle" technology.*

- 1** The base pullout features fixed top and bottom shelves and one adjustable middle shelf. Middle and bottom shelves feature chrome rails to keep items secure. Optional top inserts maximize storage.
- 2** The Acrylic Tray Insert is perfect for nail polish, makeup or other small items. And it's removable, so it can be set on the countertop for even easier access.
- 3** Use the Grooming Insert to store hair dryers, curling irons, and other hair appliances.



Shortened height and depth designed to fit into bathroom vanity cabinets

Patented "No Wiggle" hardware eliminates excess side-to-side movement

Modular design allows for the use of optional grooming organizer or acrylic tray

Smooth soft-close slides (preinstalled)

Adjustable dividers and shelf

Patented 6-way adjustable door mounting brackets allow for easy mounting of doors

Compatible with NorthPoint Cabinetry® and all other cabinetry meeting the minimum size requirements



9,661,924 & 9,723,922
10,028,581 & 10,251,480

! Accessory inserts require full door cabinet



VBPO-G01



Use the pullout by itself or customize it with an accessory insert



VBPO-T01

Scan to watch the installation video
<http://delivr.com/22TZY>



VBPO8-SC

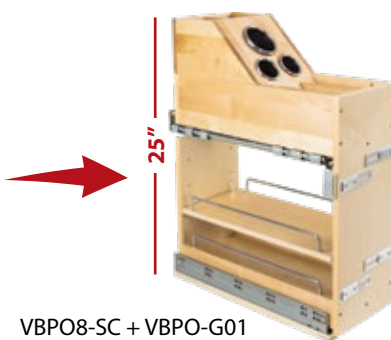

VBPO8-SC + VBPO-G01
*total assembled height = 25"



VBPO8-SC

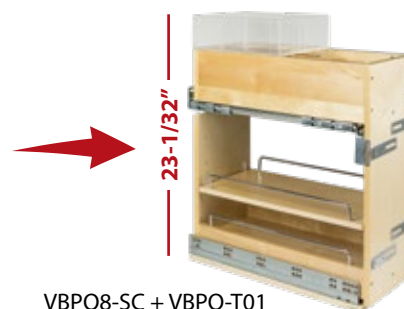

VBPO8-SC + VBPO-T01
*total assembled height = 23-1/32"

	Description	Width	Depth	Height*	Min. Opening	Standard Cabinet Size	Weight Capacity	Ctn Qty
VBPO8-SC	8" "No Wiggle" vanity pullout	8-1/2"	18-13/16"	19-7/8"	8-1/2"	12" vanity base	100 lb.	1
VBPO-G01	Grooming organizer insert	8"	18-7/32"	9"	8-1/2"	12" vanity full-height base	-	1
VBPO-T01	Acrylic tray insert	8"	10-3/32"	3-7/16"	8-1/2"	12" vanity full-height base	-	1

Screws included

*Total assembled height of Vanity Base Pullout with inserts is listed above

Wood Bottom-Mount Soft-Close Vanity Trash Can Pullout



Tuck away bathroom trash cans with this pullout, designed for mounted-door or hinged-door applications



Scan to watch the installation video
<http://delivr.com/2rstv>



6-way adjustable door-mounting brackets

CDM-WBMS35VG

Ships fully assembled and quickly mounts to the cabinet floor using four screws (included)

UV-coated and edgebanded birch plywood construction

Includes a heavy-duty plastic 35 qt. trash can in Black, White, or Grey finishes

CDM units feature patented 6-way adjustable door-mounting brackets for ease of door installation

3M™ foam tape squares included (CDM units) to hold the doors in place during installation

Features 100 lb. full-extension soft-close concealed undermount slides

Designed for standard vanity height cabinets with a 12" minimum opening width

Compatible with NorthPoint Cabinetry® and all other cabinetry meeting the minimum size requirements



Features a cubby on the backside of the unit to store extra trash bags or cleaning products



CAN-WBMS35VB



CAN-WBMS35VG



CAN-WBMS35VWH



CDM-WBMS35VB



CDM-WBMS35VWH



PATENTS
9,661,924
& 10,028,581

	Description	Can Color	Width	Depth	Height	Min. Opening	Standard Cab. Size	Weight Capacity	Ctn Qty
w/o Door Kit	CAN-WBMS35VB NEW	Single 35 qt.	Black	9-1/8"	18-7/16"	19-13/16"	12"	15" base	100 lb. 1
	CAN-WBMS35VG NEW	Single 35 qt.	Grey	9-1/8"	18-7/16"	19-13/16"	12"	15" base	100 lb. 1
	CAN-WBMS35VWH NEW	Single 35 qt.	White	9-1/8"	18-7/16"	19-13/16"	12"	15" base	100 lb. 1
w/ Door Kit	CDM-WBMS35VB NEW	Single 35 qt.	Black	9-1/8"	18-7/16"	19-13/16"	12"	15" base	100 lb. 1
	CDM-WBMS35VG NEW	Single 35 qt.	Grey	9-1/8"	18-7/16"	19-13/16"	12"	15" base	100 lb. 1
	CDM-WBMS35VWH NEW	Single 35 qt.	White	9-1/8"	18-7/16"	19-13/16"	12"	15" base	100 lb. 1

Included screws: 4 #8 X1 Coarse-Thread Wood Screws (for Cabinet), 4 #6 X 1/2" Coarse-Thread Screws (for Door)



Bathroom Organization: SlimLine Vanity Drawer Insert

Bathroom
Organizers

Organize a variety of beauty and grooming items in bathroom drawers with this clever insert



	Width	Depth	Height	Recommended Drawer	Ctn Qty
VO12A NEW	7" - 12"	16-1/2"	2-3/8"	12" wide drawer*	4
VO18A NEW	13" - 18"	16-1/2"	2-3/8"	18" wide drawer*	3

- Adjustable width to fit a variety of sized drawers
- Closed edge design for finished look
- Extender piece included to allow up to 5" width adjustability
- Trimable depth for shallower drawers
- White birch fingerjointed wood material
- Compatible with NorthPoint Cabinetry® and all other cabinetry meeting the minimum size requirements

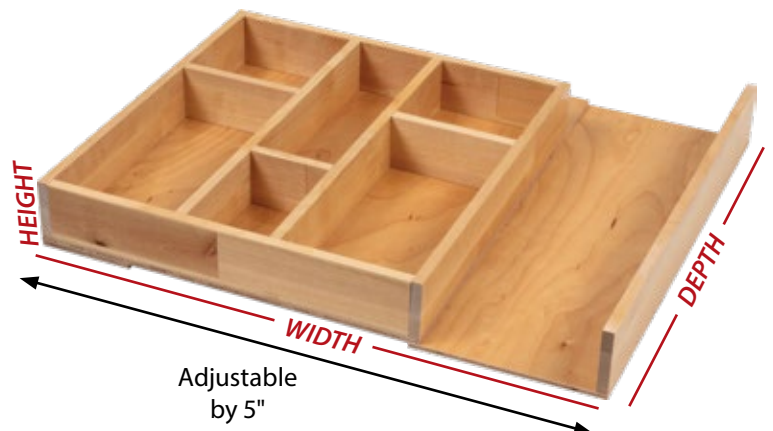

Bathroom Organization: Wire Cleaning Supply Caddy

Keep cleaning supplies close at hand with this caddy that lifts off its base for portability



Scan to watch the installation video
<https://delivr.com/26zh9>

- Removable caddy keeps cleaning supplies organized
- Holds a variety of bottles and boxes
- Mounts easily under your sink, left- or right-handed
- Plastic liner tray catches drips
- Full-extension ball bearing slides
- Heavy-duty wire construction
- 25 lb. capacity
- Quickly mounts to cabinet floor using four screws (included)
- Compatible with NorthPoint Cabinetry® and all other cabinetry meeting the minimum size requirements



Description	Finish	Width	Depth	Height	Min. Opening	Fits Standard Cabinet Size	Weight Capacity	Ctn Qty
SCPO2-R Cleaning Caddy Pullout	Polished Chrome	11-5/8"	19-11/16"	15-15/16"	11-5/8"	15" vanity base	25 lb.	2

Screws included

Bathroom Organization: Wire Basket Rollout

Bathroom
Organizers

Great for organizing towels, toiletries, and more



 SHIPS FULLY
ASSEMBLED



Scan to watch the
installation video
<https://delivr.com/2h7bh>

Full-extension ball bearing slides
Heavy-duty wire construction
Quickly mounts to cabinet floor or fixed
shelf using four screws (included)

Compatible with NorthPoint Cabinetry®
and all other cabinetry meeting the
minimum size requirements



	Description	Finish	Width	Depth	Height	Min. Opening	Fits Standard Cabinet Size	Weight Capacity	Ctn Qty
MBPO15-R	Pullout Basket	Polished Chrome	11-3/8"	19-11/16"	6-3/16"	11-1/2"	15" vanity base	50 lb.	3
MBPO18-R	Pullout Basket	Polished Chrome	14-3/8"	19-11/16"	6-3/16"	14-1/2"	18" vanity base	50 lb.	3
MBPO21-R	Pullout Basket	Polished Chrome	17-3/8"	19-11/16"	6-3/16"	17-1/2"	21" vanity base	50 lb.	3

Screws included

Bathroom Organization: Easy-to-Install Rollout Drawers



Skip the measure...design...wait... process—order rollout drawers that are in stock today



SHIPS FULLY ASSEMBLED

ROVHB15-WB shown in use

Easily and quickly installs with four screws (included)

Designed to fit standard cabinet widths; 18" depth fits most bath cabinets

Beautiful White Birch dovetail boxes with UV coating

Featuring concealed undermount full-extension, soft-close slides

Use multiple rollouts for wide cabinets

Compatible with NorthPoint Cabinetry® and all other cabinetry meeting the minimum size requirements



High-Back Drawers - 8" Back & 3" Front Drawer Height



For 12" opening
ROVHB12-WB



For 15" opening
ROVHB15-WB



For 18" opening
ROVHB18-WB



Scan to watch the product video
<http://delivr.com/2uf4p>



All you need: Measuring Tape



Phillips Screwdriver

Cordless Drill



OR



	Width	Depth	Height	Bottom	Minimum Opening	Standard Cab. Size	Weight Capacity
ROVHB12-WB	10-1/16"	18-7/16"	9"	1/4"	11-1/2"	15" vanity	100 lb.
ROVHB15-WB	13-1/16"	18-7/16"	9"	1/4"	14-1/2"	18" vanity	100 lb.
ROVHB18-WB	16-1/16"	18-7/16"	9"	1/4"	17-1/2"	21" vanity	100 lb.

It's That Easy!



Measure

Measure the cabinet's interior width, depth and height. Hold your tape parallel to the cabinet's walls. Note any pipes, shelves, or hinges that may affect actual available space.



Set

Set your drawer base in place making sure you can open and close the cabinet door easily.



Secure

Using your Phillips screwdriver (or drill) and the screws provided, secure your organizer base. Place the drawer back on the base, and you're all done!



Pair Organizers with NorthPoint Cabinetry®

Quick Cross Reference Guide



Waste Container Solutions

Cabinet	Wood Bottom Mount - Double Can				Wood Bottom Mount - Single Can				Wood Top Mount - Double Can				Wood Top Mount - Single Can						
	CDM-WBMD35X	CAN-WBMD35X	CDM-WBMD3518X	CAN-WBMD3518X	CAN-WBMD3521X NEW	CDM-WBMD50X	CAN-WBMD50X	CDM-WBMS35X	CAN-WBMS35X	CAN-WBMS35VX NEW	CDM-WBMS50X	CAN-WBMS50X	CAN-TMD1535X-K	CAN-TMD1835X-K	CAN-TMD2135X-K	CAN-TMS1235X-K	CAN-TMS1250X-K	CAN-TMS1535X-K	CAN-TMS1550X-K
B15								•	•	•						•			
B18	•	•											•					•	
B21			•	•										•					
B24					•										•				
BFH15								•	•		•	•				•	•		
BFH18	•	•				•	•						•					•	•
VB15										•									



Cabinet	Wire - Double Can				Wire - Single Can			Metal - Double Can		Metal - Single Can		Storage with Style - Double Can		Storage with Style - Single Can	
	CAN-EBMDXX	CAN-EBMD50XX	WC-EMBM-D35G	WC-EMBM-D50G	CAN-EBMSXX	WC-EMBM-S35G	WC-EMBM-S50G	CAN-MDB5-D35G	CAN-MDB5-D50G	CAN-MDB5-S35G	SWS-MBMD35GXX	SWS-MBMD50GXX	SWS-MBMS35GXX		
B15					•	•				•			•		
B18	•		•					•			•				
BFH15					•	•	•			•			•		•
BFH18	•	•	•	•				•	•		•	•			

NorthPoint Cabinetry® Cross Reference Guide

Cabinet
Organizers

Base Cabinet Solutions

Cabinet	Base Pullouts													Storage with Style				Mixer Lift		Wire Pullouts				Under-Sink Mat	
	BPO2-5SC	BPO2-8SC	BPO2-11SC	BPO2-14SC	DBPO-8SC	UBPO-5SC	UBPO-8SC	BPOTD2-5SC	BPOTD2-8SC	KBPO-5SC	KBPO-8SC	SWS-BPO5XX	SWS-BPO8XX	SWS-DBPO8XX	SWS-UBPO8	ML-1CH	SCPO2-R	MPLO215-R	MPPO215-R	MBPO15-R	MBPO18-R	MBPO21-R	USM-G		
BFH09	•					•		•		•		•													
BFH12		•					•		•		•		•												
BFH15			•													•		•	•	•	•				
BFH18				•											•		•	•	•		•				
B12					•				•					•											
B15																	•	•	•	•					
B18																	•	•	•		•				
B21																						•			
SB36																								•	
SBF36																								•	

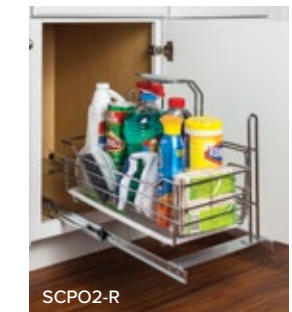
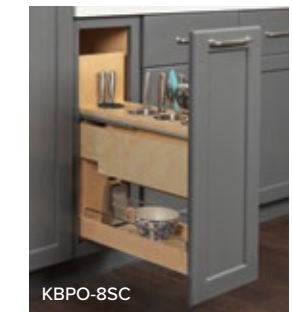
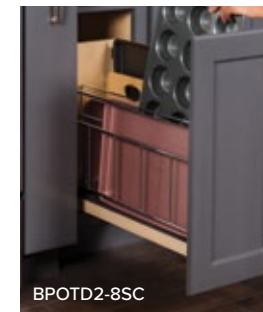

Rollout Solutions

Cabinet	Wood Rollouts	RO12	RO15	RO18	RO21	RO24	RO27	RO33	Cookware & Bottle Rollouts	ROBTD15-WB	ROBTD21-WB	ROBTD27-WB	ROCWS15-WB	ROCWS21-WB	ROCWS27-WB	ROCWD15-WB	ROCWD21-WB	ROCWD27-WB
B15		•																
B18			•							•			•			•		
B21				•														
B24					•						•			•			•	
B27						•												
B30							•					•			•			•
B36								•										

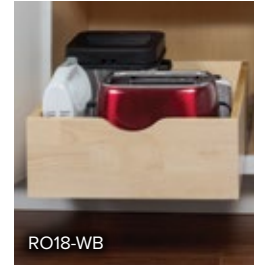
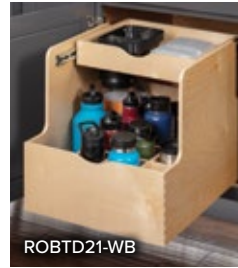

Drawer Solutions

Cabinet	Inserts	CO15A	CO21A	CD15	CD18	CD21	CD24	DO15A-B18	DO21A-B24	KO18-B21	SPO15-B18	SPO24-B27	AU021-B24	KCCO15	KCCO21	KNCD15	KNCD21	Tipout Tray	TO11/TOSS11	TO14/TOSS14
B15		•		•				•						•						
B18		•			•			•			•			•		•				
B21			•			•			•	•	•				•					
B24			•				•		•	•	•				•		•			
B27			•						•	•	•	•								
SB30																			•	
SB33																			•	
SB36																			•	•
SB39																			•	•

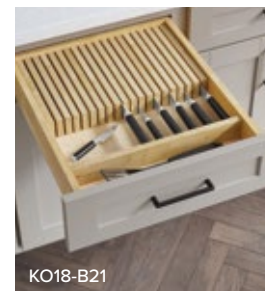
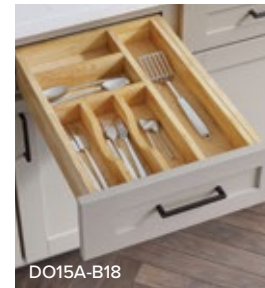

NorthPoint Cabinetry® Cross Reference Guide

Base Corner Solutions

Cabinet	Blind Corner Organizers	Corner Organizers	Wood Lazy Susans	Plastic Lazy Susans
BBC42-45U	•			
BBC45-48U		•		
BC36U			•	•

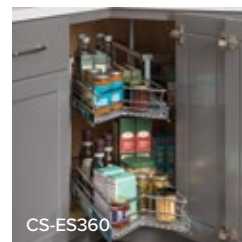
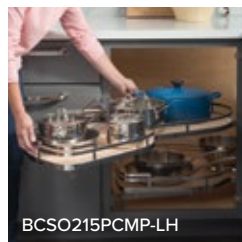

Pantry Solutions

Cabinet	Pantry Pullouts	Storage with Style	Tray Dividers
UP1896	•	•	
UP1890	•	•	•
UP1884	•	•	•
UP2496		•	
UP2490		•	•
UP2484		•	•
UP3096			•
UP3090			•
UP3084			•

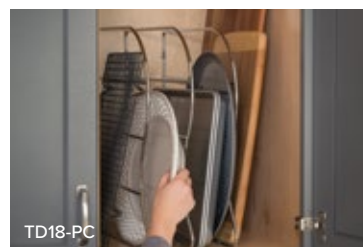
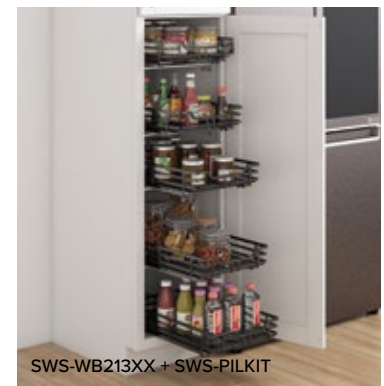

Wall Cabinet Solutions

Cabinet	Wall Pullouts	WPO2-265SC	WPO2-268SC	WPO2-325SC	WPO2-328SC	Door Mounted	SPR9A	SPR12A	SPR15A	DMS3-PC-R	DMS6-PC-R	Spice Pulldown	TTSPD-R
W0930		•											
W0936				•									
W1230			•										
W1236					•								
W1530							•			•	•		
W1536							•			•	•	•	
W1542							•			•	•		
W1830								•					•
W1836								•					•
W1842								•					•
W2130									•				
W2136									•				
W2142									•				
W2730							•			•	•		
W2736							•			•	•		•
W2742							•			•	•		
W3312													•
W3315													•
W3318													•
W3324													•
W3330								•					•
W3336								•					•
W3342								•					•
W4236									•				



WPO2-268SC

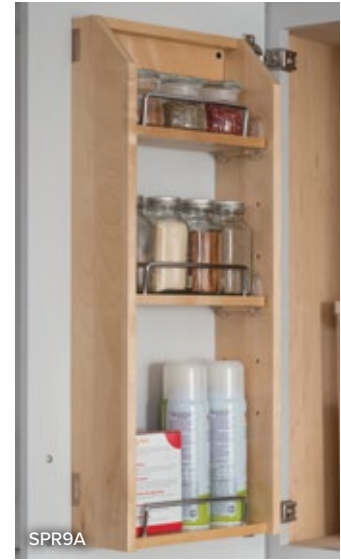

SPR9A

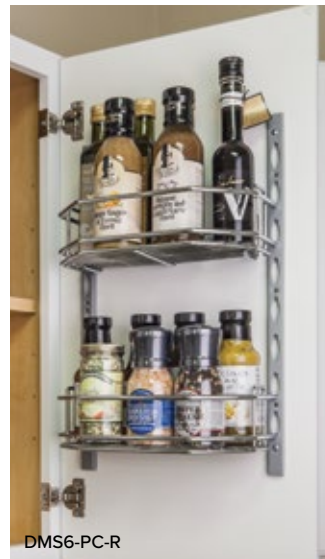

DMS6-PC-R



TTSPD-R

Wall Corner Solutions

Cabinet	Wood Lazy Susan	BLSR218-SET	BLSR2318-SET	BLSR18-S	BLSR2320-SET	BLSR220-SET	BLSR20-S	LSR218-SET	LSR2318-SET	LSR18-S	Plastic Lazy Susan	PLSMR18	PLSMR318	PLSR218	PLSR2318	Wire Lazy Susan	MLSR18-S-R
WDC2430		•		•				•	•	•	•	•	•	•	•		•
WDC2436		•		•				•	•	•	•	•	•	•	•		•
WDC2442			•						•	•			•		•		•
WDC273615						•	•										
WDC274215					•		•										

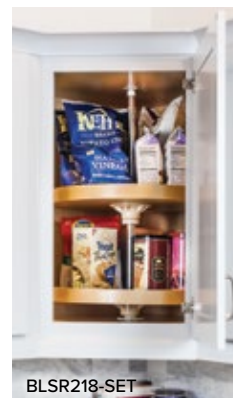

BLSR218-SET



MLSR18-S-R

NorthPoint Cabinetry® Cross Reference Guide

Cabinet
Organizers

Vanity Cabinet Solutions

Cabinet	Vanity Pullouts	VBPO-85C	VBPO-85C & VBPO-G01	PVGD15-SC	Vanity Trash Can Pullouts	CAN-WBMS35VXX	CDM-WBMS35VXX	Vanity Drawer Insert	VO12A	VO18A	Tipout Tray	TO11/TOSS11	TO14/TOSS14	Wood Rollouts	ROVHB12-WB	ROVHB15-WB	ROVHB18-WB	Wire Pullouts	SCPO2-R	MBPO15-R	MBPO18-R	MBPO21-R
VB12	•							•														
VB15					•	•		•							•							
VB18										•						•			•	•		
VFH12			•																•		•	
VDB12-3								•														
VDB15-3								•											•	•		
VDB18-3				•						•									•		•	
VDB21-3										•												•
VBTD42								•									•					
VBTD48								•														
VS27												•										
VS30												•										
VS33													•									
VS36													•									
VS42													•				•					

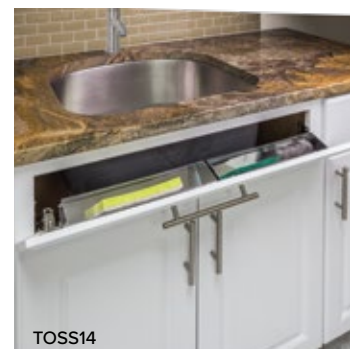
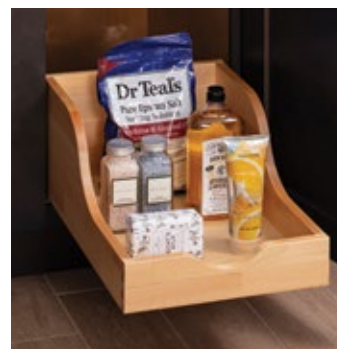

Make closet organization a whole lot easier



What's New in Closets

Elevate your closet designs with the hottest home trend—the sleek and sophisticated look of **matte black** hardware. This stunning, non-reflective finish complements any style, from minimalist to luxurious, creating a bold statement in any room. Say goodbye to fingerprints and smudges as this low-maintenance surface keeps closet hardware looking flawless. With its versatility and eye-catching allure, the matte black finish is the ultimate choice for those seeking a chic and on-trend closet upgrade.



1 Matte Black Shoe Fences
page 456

2 Matte Black Pullout Belt Rack
page 463

3 Matte Black Pullout Tie Rack
page 463

4 Matte Black Round Closet Rods
pages 474-479

5 Matte Black Telescoping Valet Rod
page 468

6 Matte Black Pullout Pant Rack
page 462

MAXIMIZE YOUR SPACE

Pullout Tie Rack

With our pullout tie rack, a large selection of ties can be quickly accessed then easily stowed away. This is a much neater solution than piling ties into a drawer.

Cascading Tie Organizer

Store 12 ties, scarves, or belts in a small footprint on our 12-hook cascading tie organizer. Its narrow vertical design works great on the face of a closet casing or for tight spaces like behind a door.

Closet Rod

Our quality closet rods are durable and easy to install. Round, oval, and lighted options are available.

Shoe Fence

Our shoe fences keep footwear or other items on display while preventing them from sliding off of angled shelves.

Pullout Pant Rack

Our pullout pant rack provides a quick and wrinkle-free way to store multiple pairs of pants in a compact footprint.

Cabinet Knobs and Pulls

We produce a variety of high quality cabinet knobs and pulls to suit any style.

Get the most out of your closet with our clever products.

Puck Light

Illuminate shelves and cubbies with one of our puck light options. Beautiful, functional lighting can take your closet to the next level.

Wardrobe Lift

Increase your closet capacity by utilizing the overhang space with a wardrobe lift. One pull of the adjustable handle brings your overhead clothing within reach. An integrated hydraulic system ensures smooth lowering.

Pullout Belt Rack

Our pullout belt rack makes belt storage a breeze. This rack keeps multiple belts readily accessible.



Jewelry Tray

These felt-lined trays are a stylish way to organize your accessories in a drawer.

Lighted Closet Rod Fixture

Illuminate your morning routine by making it easier to see and select the perfect outfit with our innovative lighted rods.

Shoe Fence



- Keeps shoes and other items from sliding off closet shelves
- Allows for easy organization of shoes and other items on a shelf
- Available in 17", 23", and 29" lengths
- Heavy-duty steel railing available in our most popular finishes
- Easy to install with press-in dowels
- Designed to fit in 5 mm holes on 32 mm spacing



	17" Shoe Fence	23" Shoe Fence	29" Shoe Fence
Dimensions	17" W x 1/2" D x 1-3/16" H	23" W x 1/2" D x 1-3/16" H	29" W x 1/2" D x 1-3/16" H
Dark Bronze	SF17-ORB	SF23-ORB	SF29-ORB
Polished Chrome	SF17-PC	SF23-PC	SF29-PC
Satin Nickel	SF17-SN	SF23-SN	SF29-SN
Matte Black <i>Coming Soon!</i>	SF17-MB	SF23-MB	SF29-MB
	6 pcs/box 60 pcs/ctn	6 pcs/box 48 pcs/ctn	6 pcs/box 36 pcs/ctn

Pullout Baskets



- 100 lb. full-extension ball bearing slides included
- Heavy-duty wire construction
- Rubber covers on slide hooks keep basket securely in place but allow easy removal of basket
- Closed corners allow smaller items to be stored without falling out
- Available finishes:
Chrome, Dark Bronze and Satin Nickel
- For closets 14" deep or 16" deep



Chrome Basket



Dark Bronze Basket



Satin Nickel Basket

1 mm thick clear plastic material with opaque finish

Fitted to basket bottom for easy drop-in installation

Creates a smooth bottom surface for closet applications



Plastic Liner

Thick canvas material with velcro closures

Machine washable

Fitted to basket even after washing

Great for delicate clothing in closet applications



Canvas Liner

Pullout Baskets

For 18" wide closets

14" Depth Basket

Dimensions	17-3/4" W x 14" D x 6" H	17-3/4" W x 14" D x 11" H	17-3/4" W x 14" D x 17" H
Weight Capacity	100 lb.	100 lb.	100 lb.
Chrome Basket	POB1-14176CH	POB1-141711CH	POB1-141717CH
Dark Bronze Basket	POB1-14176ORB	POB1-141711ORB	POB1-141717ORB
Satin Nickel Basket	POB1-14176SN	POB1-141711SN	POB1-141717SN
Canvas Liner	BCL-14176-TAN	BCL-141711-TAN	BCL-141717-TAN*
Plastic Liner	POB1PL-14176	POB1PL-141711	POB1PL-141717*
Recommended screw:	#8 truss head or 7 mm Euro screw	#8 truss head or 7 mm Euro screw	#8 truss head or 7 mm Euro screw
	4 pcs/master	4 pcs/master	4 pcs/master

16" Depth Basket

Dimensions	17-3/4" W x 16" D x 6" H	17-3/4" W x 16" D x 11" H	17-3/4" W x 16" D x 17" H
Weight Capacity	100 lb.	100 lb.	100 lb.
Chrome Basket	POB1-16176CH	POB1-161711CH	POB1-161717CH
Dark Bronze Basket	POB1-16176ORB	POB1-161711ORB	POB1-161717ORB
Satin Nickel Basket	POB1-16176SN	POB1-161711SN	POB1-161717SN
Canvas Liner	BCL-16176-TAN	BCL-161711-TAN	BCL-161717-TAN*
Plastic Liner	POB1PL-16176	POB1PL-161711	POB1PL-161717*
Recommended screw:	#8 truss head or 7 mm Euro screw	#8 truss head or 7 mm Euro screw	#8 truss head or 7 mm Euro screw
	4 pcs/master	4 pcs/master	4 pcs/master

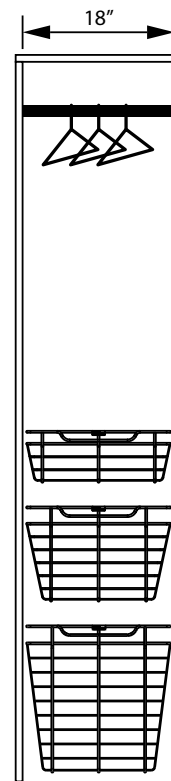

For 24" wide closets

14" Depth Basket

Dimensions	23-3/4" W x 14" D x 6" H	23-3/4" W x 14" D x 11" H	23-3/4" W x 14" D x 17" H
Weight Capacity	100 lb.	100 lb.	100 lb.
Chrome Basket	POB1-14236CH	POB1-142311CH	POB1-142317CH
Dark Bronze Basket	POB1-14236ORB	POB1-142311ORB	POB1-142317ORB
Satin Nickel Basket	POB1-14236SN	POB1-142311SN	POB1-142317SN
Canvas Liner	BCL-14236-TAN	BCL-142311-TAN	BCL-142317-TAN*
Plastic Liner	POB1PL-14236	POB1PL-142311	POB1PL-142317*
Recommended screw:	#8 truss head or 7 mm Euro screw	#8 truss head or 7 mm Euro screw	#8 truss head or 7 mm Euro screw
	4 pcs/master	4 pcs/master	4 pcs/master

16" Depth Basket

Dimensions	23-3/4" W x 16" D x 6" H	23-3/4" W x 16" D x 11" H	23-3/4" W x 16" D x 17" H
Weight Capacity	100 lb.	100 lb.	100 lb.
Chrome Basket	POB1-16236CH	POB1-162311CH	POB1-162317CH
Dark Bronze Basket	POB1-16236ORB	POB1-162311ORB	POB1-162317ORB
Satin Nickel Basket	POB1-16236SN	POB1-162311SN	POB1-162317SN
Canvas Liner	BCL-16236-TAN	BCL-162311-TAN	BCL-162317-TAN*
Plastic Liner	POB1PL-16236	POB1PL-162311	POB1PL-162317*
Recommended screw:	#8 truss head or 7 mm Euro screw	#8 truss head or 7 mm Euro screw	#8 truss head or 7 mm Euro screw
	4 pcs/master	4 pcs/master	4 pcs/master

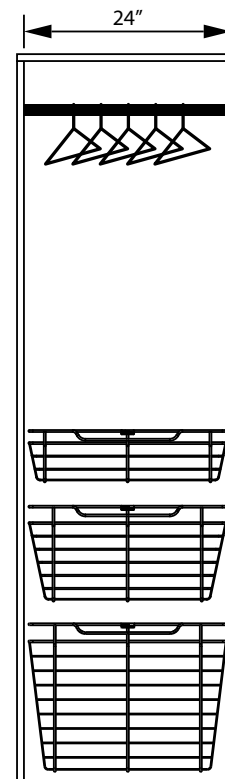

Pullout Baskets

For 30" wide closets

14" Depth Basket

Dimensions	29-3/4" W x 14" D x 6" H	29-3/4" W x 14" D x 11" H	29-3/4" W x 14" D x 17" H
Weight Capacity	100 lb.	100 lb.	100 lb.
Chrome Basket	POB1-14296CH	POB1-142911CH	POB1-142917CH
Dark Bronze Basket	POB1-14296ORB	POB1-142911ORB	POB1-142917ORB
Satin Nickel Basket	POB1-14296SN	POB1-142911SN	POB1-142917SN
Canvas Liner	BCL-14296-TAN	BCL-142911-TAN	BCL-142917-TAN*
Plastic Liner	POB1PL-14296	POB1PL-142911	POB1PL-142917*
Recommended screw:	#8 truss head or 7 mm Euro screw	#8 truss head or 7 mm Euro screw	#8 truss head or 7 mm Euro screw
	4 pcs/master	4 pcs/master	4 pcs/master

16" Depth Basket

Dimensions	29-3/4" W x 16" D x 6" H	29-3/4" W x 16" D x 11" H	29-3/4" W x 16" D x 17" H
Weight Capacity	100 lb.	100 lb.	100 lb.
Chrome Basket	POB1-16296CH	POB1-162911CH	POB1-162917CH
Dark Bronze Basket	POB1-16296ORB	POB1-162911ORB	POB1-162917ORB
Satin Nickel Basket	POB1-16296SN	POB1-162911SN	POB1-162917SN
Canvas Liner	BCL-16296-TAN	BCL-162911-TAN	BCL-162917-TAN*
Plastic Liner	POB1PL-16296	POB1PL-162911	POB1PL-162917*
Recommended screw:	#8 truss head or 7 mm Euro screw	#8 truss head or 7 mm Euro screw	#8 truss head or 7 mm Euro screw
	4 pcs/master	4 pcs/master	4 pcs/master

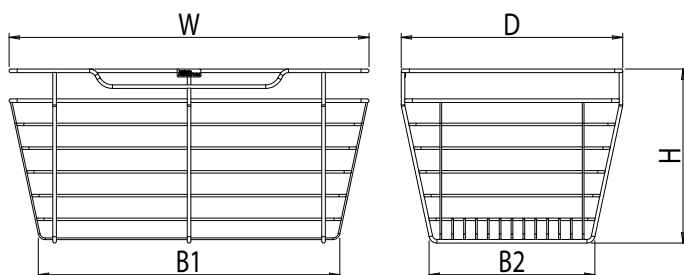
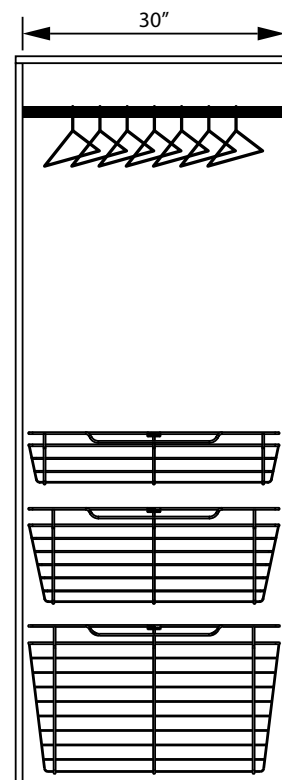

	W	D	H	B1	B2
POB1-141711	17"	14"	11"	13-1/16"	10-1/2"
POB1-161711	17"	16"	11"	13-1/16"	12-1/2"
POB1-142311	23"	14"	11"	19-1/16"	10-1/2"
POB1-162311	23"	16"	11"	19-1/16"	12-1/2"
POB1-142911	29"	14"	11"	25-1/16"	10-1/2"
POB1-162911	29"	16"	11"	25-1/16"	12-1/2"

Slides add additional 1" to width

	W	D	H	B1	B2
POB1-14176	17"	14"	6"	15"	12-3/8"
POB1-16176	17"	16"	6"	15"	14-3/8"
POB1-14236	23"	14"	6"	21"	12-3/8"
POB1-16236	23"	16"	6"	21"	14-3/8"
POB1-14296	29"	14"	6"	27"	12-3/8"
POB1-16296	29"	16"	6"	27"	14-3/8"

Slides add additional 1" to width

	W	D	H	B1	B2
POB1-141717	17"	14"	17"	13"	10-9/16"
POB1-161717	17"	16"	17"	13-3/16"	12-9/16"
POB1-142317	23"	14"	17"	19-1/8"	10-9/16"
POB1-162317	23"	16"	17"	19-3/16"	12-9/16"
POB1-142917	29"	14"	17"	25-1/8"	10-9/16"
POB1-162917	29"	16"	17"	25-3/16"	12-9/16"

Slides add additional 1" to width

Pullout Nylon Hamper



- 100 lb. full-extension ball bearing slides included
- Heavy-duty wire frame construction
- Heavy-duty 19" tall black nylon bag featuring ventilated mesh sides and central divider
- Bag is easily removable and includes carry handles
- For closets 14" deep or 18" deep
- Interior divider to keep clothing separated by wash type



For 18" wide closets

14" Depth Hamper

Dimensions	18" W x 14" D x 22-1/2" H
Weight Capacity	100 lb.
Chrome Frame	POHS-14PC
Dark Bronze Frame	POHS-14ORB
Satin Nickel Frame	POHS-14SN
Replacement bag	POHS14-BAG

Recommended screw: #8 truss head or 7 mm Euro screw

4 pcs/master

For 24" wide closets

18" Depth Hamper

Dimensions	24" W x 18" D x 22-1/2" H
Weight Capacity	100 lb.
Chrome Frame	POHS-18PC
Dark Bronze Frame	POHS-18ORB
Satin Nickel Frame	POHS-18SN
Replacement bag	POHS18-BAG

Recommended screw: #8 truss head or 7 mm Euro screw

4 pcs/master

Pullout Plastic Hamper



Chrome wire pullout with white plastic hamper and lid included

Designed to fit in a 14" deep, 24" wide closet opening

Features 100 lb. full-extension ball bearing slides

Mounts to the closet bottom

Optional door mounting bracket sold separately (item # CAN-DOORKITPC)

Installs with just 4 screws



For 24" wide closets

Plastic Hamper Pullout

Dimensions	19-3/16" W x 13-3/4" D x 22-11/16" H
Weight Capacity	100 lb.
Chrome Frame + White Hamper	HP-BM1424WPC
Replacement hamper	PH-63W
Door Mounting Kit (Chrome)	CAN-DOORKITPC
Recommended screw:	#8 flat head

1 pc/box

Pullout Pant Rack



Features patented 32 mm Quick-brac™ bracket for easy installation

Features 100 lb. ball bearing slides

Designed for 14" deep closets

Available in three widths: 18", 24", and 30" and our most popular finishes

Width has 3/4" adjustment

Euro screws provided for 32 mm installation



PATENT

10,149,540
& 10,028,578



Scan to watch the installation video

<http://delivr.com/2T73J>

	18" Pant Rack	24" Pant Rack	30" Pant Rack
Dimensions	Adj. 17-3/8"–18-1/8" W 14" D x 3-1/16" H 9 arms	Adj. 23-3/4"–24-1/2" W 14" D x 3-1/16" H 13 arms	Adj. 29-3/4"–30-1/2" W 14" D x 3-1/16" H 16 arms
Weight Capacity	100 lb.	100 lb.	100 lb.
Dark Bronze	PPR-1814-ORB	PPR-2414-ORB	PPR-3014-ORB
Polished Chrome	PPR-1814-PC	PPR-2414-PC	PPR-3014-PC
Satin Nickel	PPR-1814-SN	PPR-2414-SN	PPR-3014-SN
Matte Black <i>Coming Soon!</i>	PPR-1814-MB	PPR-2414-MB	PPR-3014-MB
	1 pc/box	1 pc/box	1 pc/box

14" Belt & Tie Racks



- Features patented 32 mm Quick-brac™ bracket for easy installation
- Belt rack has 6 double hooks (12 hooks) to hold an array of belt sizes
- Tie rack has 18 hooks, perfect for organizing multiple ties or scarves
- Features 100 lb. push-to-open ball bearing slides

- Easily mounts left or right handed
- Designed for 14" deep closets
- Available in our most popular finishes
- Euro screws provided for 32 mm installation



PATENT
10,149,540

Mounts left or right handed



14" Belt Rack



14" Tie Rack

Dimensions	13-1/2" W x 1-15/16" D x 2-9/16" H 6 double hooks (12 hooks)	13-1/2" W x 2-7/8" D x 2-9/16" H 18 hooks
Weight Capacity	50 lb.	50 lb.
Dark Bronze	355B-ORB	355T-ORB
Polished Chrome	355B-PC	355T-PC
Satin Nickel	355B-SN	355T-SN
Matte Black <i>Coming Soon!</i>	355B-MB	355T-MB
	1 pc/box	1 pc/box

Tri-Level Tie Organizer

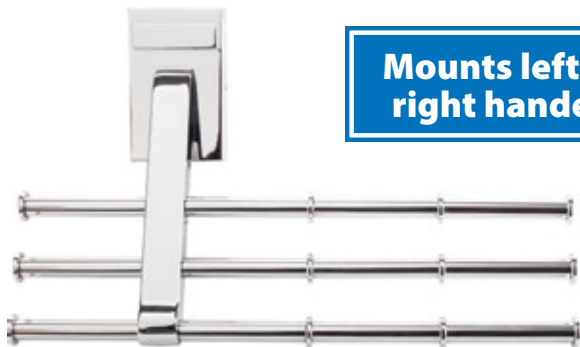

Mounts left or right handed

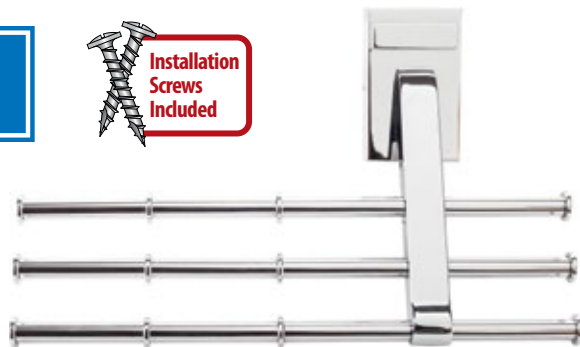

- Holds up to 12 ties or scarves
- Lip on end of each arm prevents items from sliding off
- Arms can be configured for left or right-hand use
- Compact design has small footprint when installed
- Hidden mounting hardware
- Mounts with 2 screws (included)

Tri-Level Tie Organizer

Dimensions		6-3/4" W x 2" D x 4" H
Brushed Oil Rubbed Bronze		356T-DBAC
Polished Chrome		356T-PC
Satin Nickel		356T-SN
Matte Black <i>Coming Soon!</i>		356T-MB

4 pcs/box

Cascading Tie Organizer

- Great for ties, scarves, and belts
- 12 free-swinging hooks
- Lip on end of each hook prevents items from sliding off
- Non-handed unit can be mounted for left or right-hand use
- Vertical design has small footprint when installed
- Quick and easy mounting with 2 screws



Cascading Tie Organizer

Dimensions	1-1/2" W x 2-7/8" D x 10-1/4" H
Weight Capacity	30 lb.

Brushed Oil Rubbed Bronze 357T-DBAC

Polished Chrome 357T-PC

Satin Nickel 357T-SN

Matte Black **Coming Soon!** 357T-MB

4 pcs/box



PATENT
D727,632



12" Sliding Belt & Tie Racks, Valet Rod

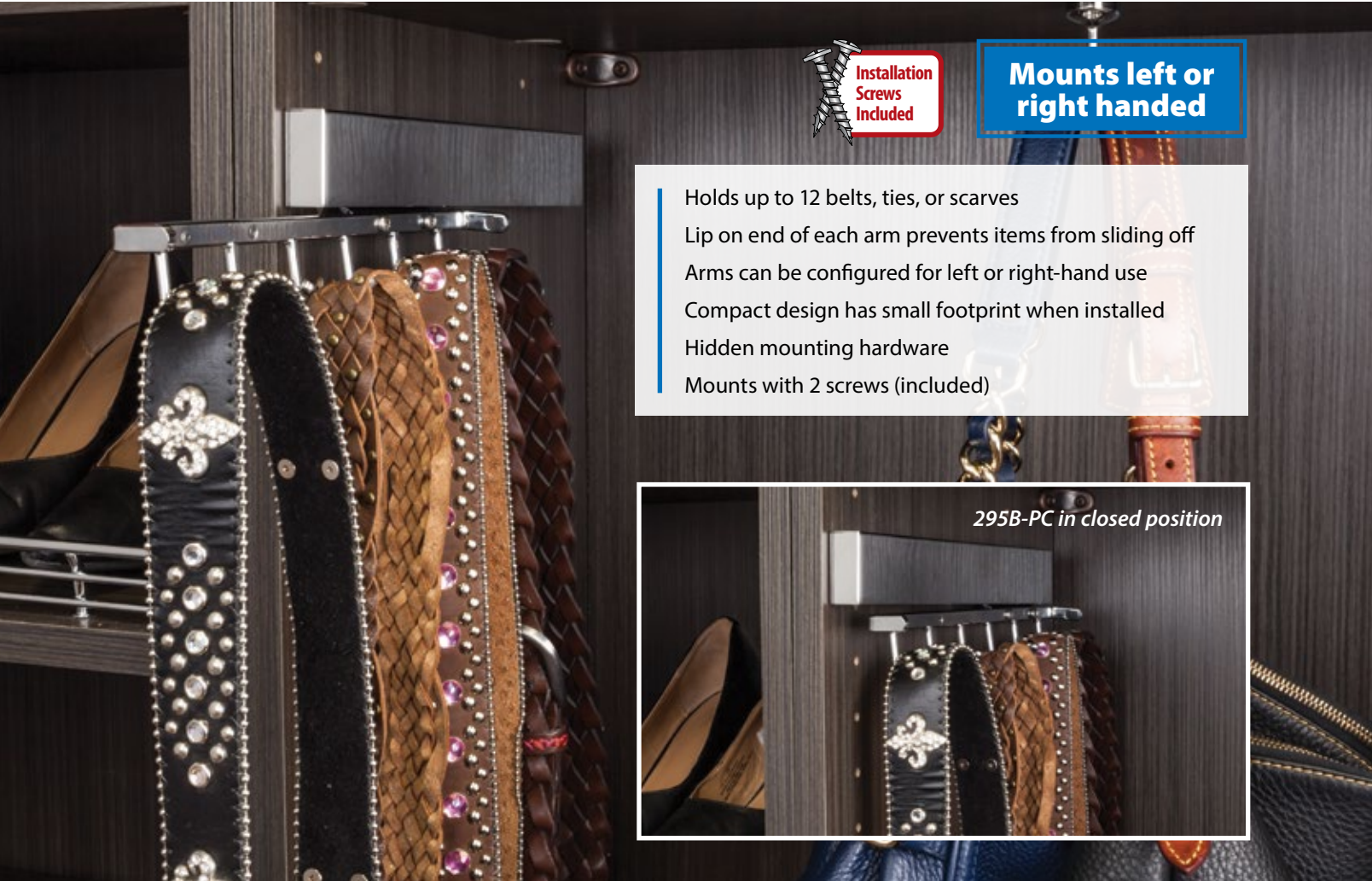

Mounts left or right handed

- Holds up to 12 belts, ties, or scarves
- Lip on end of each arm prevents items from sliding off
- Arms can be configured for left or right-hand use
- Compact design has small footprint when installed
- Hidden mounting hardware
- Mounts with 2 screws (included)

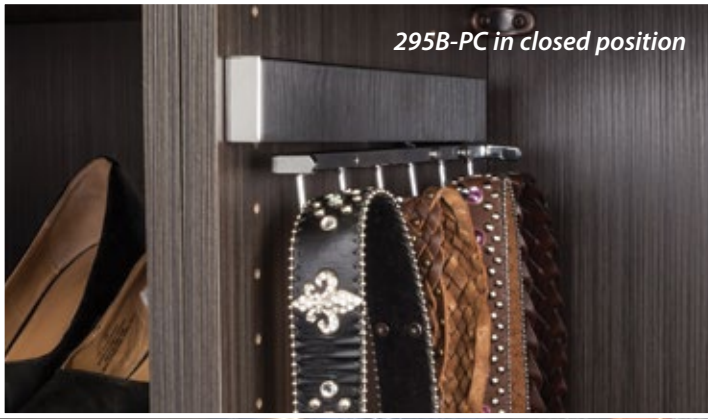

Sliding Belt Rack



Sliding Tie Rack



Sliding Wardrobe/Valet Rod

Dimensions	295 mm (11-5/8") Overall Length 6 belt hooks, 50 mm spacing	295 mm (11-5/8") Overall Length 6 sets of pegs to hold 12 ties	295 mm (11-5/8") Overall Length Built-in stopper on ends
Weight Capacity	50 lb.	50 lb.	50 lb.
Brushed Oil Rubbed Bronze	295B-DBAC	295T-DBAC	295W-DBAC
Polished Chrome	295B-PC	295T-PC	295W-PC
Matte Black <i>Coming Soon!</i>	295B-MB	295T-MB	295W-MB
	1 pc/box 20 sets/ctn	1 pc/box 20 sets/ctn	1 pc/box 20 sets/ctn

Screw-Mount Racks

Mounts easily with the included wood screws in tight spaces where you may not have the room for a sliding accessory rack

Simple way to organize ties, belts, scarves or necklaces

Each rack is polybagged with attachment screws and UPC labeled

Belt rack has 6 hooks, and tie rack has 6 double hooks

Each hook has a slip resistant clear vinyl cover

Multiple applications including pantries, utility rooms, closets or anywhere that needs an optimized storage solution for hanging items



Screw-Mount Belt Rack



Screw-Mount Tie Rack

Dimensions	11" W x 1-3/4" D x 1-3/4" H 6 belt hooks, 50 mm spacing	11" W x 2-1/4" D x 2" H 6 sets of pegs to hold 12 ties
Weight Capacity	30 lb.	30 lb.
Brushed Oil Rubbed Bronze	296B-DBAC	296T-DBAC
Polished Chrome	296B-PC	296T-PC
Matte Black Coming Soon!	296B-MB	296T-MB

1 pc/polybag
40 sets/ctn

1 pc/polybag
40 sets/ctn

Telescoping Valet Rod



Telescoping valet rods are the perfect accessory for any closet. They allow you to easily organize your clothes for the next day. Fully extended, they add an additional 10" of hanging space. With a 30 lb. weight capacity, they can easily hold business suits or garment bags. Individually boxed with attachment hardware and installation instructions.

- For clothes hangers and hanging garment bags
- 30 lb. weight capacity
- Material: Anodized Aluminum
- Installation hardware and instructions included



355V-PC
Polished Chrome

14" Telescoping Valet Rod

Dimensions	1-1/16" W x 13-11/13" D x 1-13/16" H
Weight Capacity	30 lb.
Polished Chrome	355V-PC
Matte Black <i>Coming Soon!</i>	355V-MB

1 set/box
12 sets/ctn

Mounts left or right handed



Laundry Valet

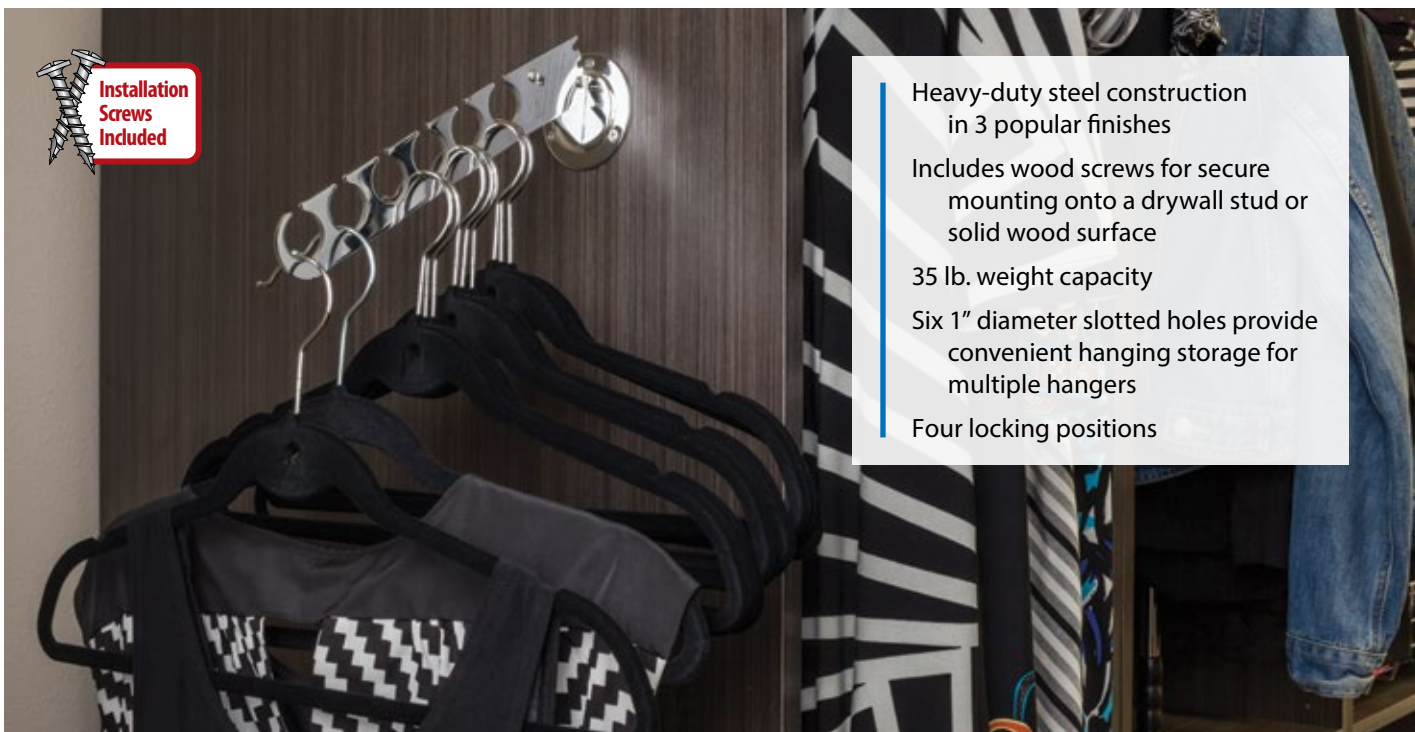

Our heavy-duty laundry valet offers convenient and stylish hanging storage for your garments. The valet features an adjustable design that locks into four different angled positions and folds down when not in use. Its six slotted hole design can hold multiple hangers at a time, and wire neck hangers can easily be moved around. This versatile hanger is great for hanging garments to air dry in a laundry room, to hold coats in a closet or mudroom, or to create additional hanging space in the closet.



Laundry Valet

Dimensions	3" W x 10-15/16" D x 3" H
Weight Capacity	35 lb.
Brushed Oil Rubbed Bronze	276LV-DBAC
Polished Chrome	276LV-PC
Satin Nickel	276LV-SN
Matte Black <i>Coming Soon!</i>	276LV-MB

4 pcs/box
32 pcs/ctn

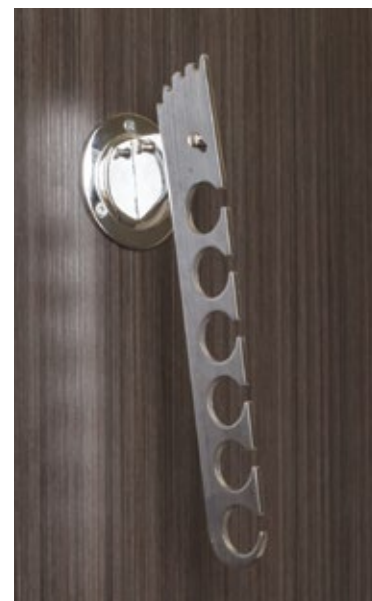

276LV-PC in down position

Wardrobe Lift



Side-mount wardrobe lift with 45 lb. weight capacity
 Heavy-duty steel construction with plastic housing and handle
 Three sizes available and width adjustable to fit a wide range of openings
 Handle is adjustable for different desired heights
 Instructions, mounting hardware and bumper stops included (some assembly required)
Note: Max handle extension is 41-1/2"



Bumper prevents over-extension of arm

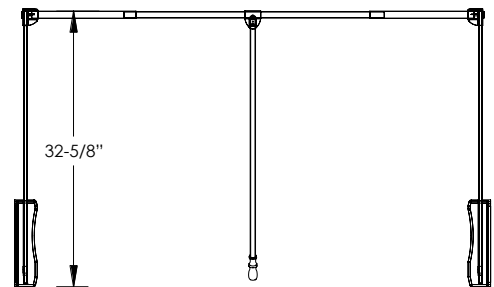

	For 21" – 24" openings	For 25-1/2" – 35" openings	For 33" – 48" openings
Weight Capacity	45 lb.	45 lb.	45 lb.
Chrome with Black Handle & Housing	1521	1523	1532
Black	–	1523-BLK	1532-BLK
	1 set/box 6 sets/ctn	1 set/box 6 sets/ctn	1 set/box 6 sets/ctn

Wardrobe Lift: Integrated Soft Open & Close

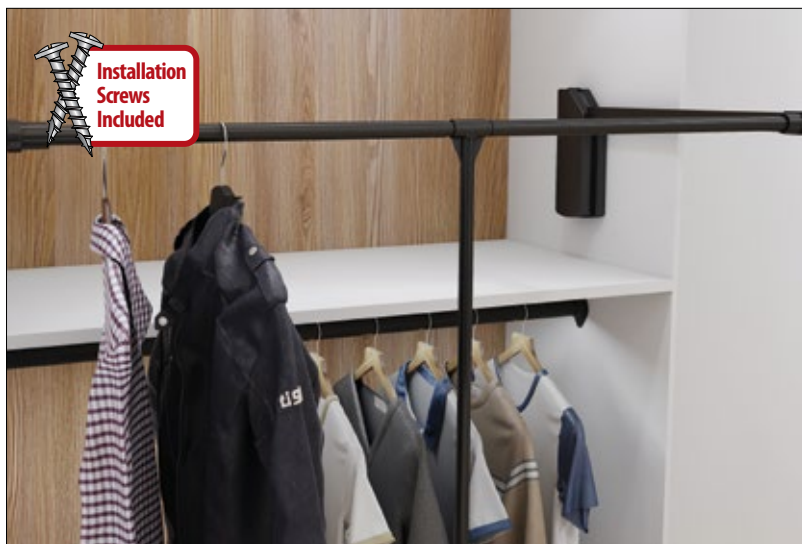

- Integrated soft-close & soft-open ensures smooth operation up & down
- Side-mount wardrobe lift with 45 lb. weight capacity
- Heavy-duty steel construction with plastic housing & handle
- Two sizes available and width adjustable to fit a wide range of openings
- Handle is adjustable for different desired heights
- Features mounting brackets to make installation easier and provide a clean finished look
- Instructions and mounting hardware included (some assembly required)

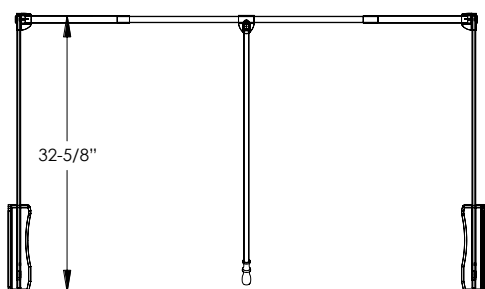

Soft-close & soft-open bumper for smooth operation

Hidden mounting screws



	For 25-1/2" – 35" openings	For 33" – 48" openings
Weight Capacity	45 lb.	45 lb.
Chrome with Silver Handle & Housing	1523SC-PC	1532SC-PC
Black	1523SC-BLK	1532SC-BLK
	1 set/box 4 sets/ctn	1 set/box 4 sets/ctn

Jewelry Trays



This felt-lined jewelry drawer is a perfect way to complete your closet. The jewelry organizer comes in two different configurations: a 5 compartment deep organizer and a 10 compartment shallow organizer with ring insert. Both jewelry drawers are available in black or grey. The jewelry drawer is designed as a complete drawer solution with our 100 lb. soft-close slides preinstalled. Works great behind a set of doors or you can mount a drawer front for a more finished look.



5 Compartment Jewelry Organizer

10 Compartment Jewelry Organizer

Dimensions	23-7/8" W x 14" D x 4" H	23-7/8" W x 14" D x 2" H
Black	JD1-24-BL	JD1-24R-BL
Grey	JD1-24-GR	JD1-24R-GR
Recommended screw:	#8 truss head or 7 mm Euro screw	#8 truss head or 7 mm Euro screw
	1/box 4/ctn	1/box 4/ctn

- MDF construction, felt-lined
- Drawer front can be mounted to front of tray
- Ships fully assembled and ready to install
- 100 lb. soft-close slides

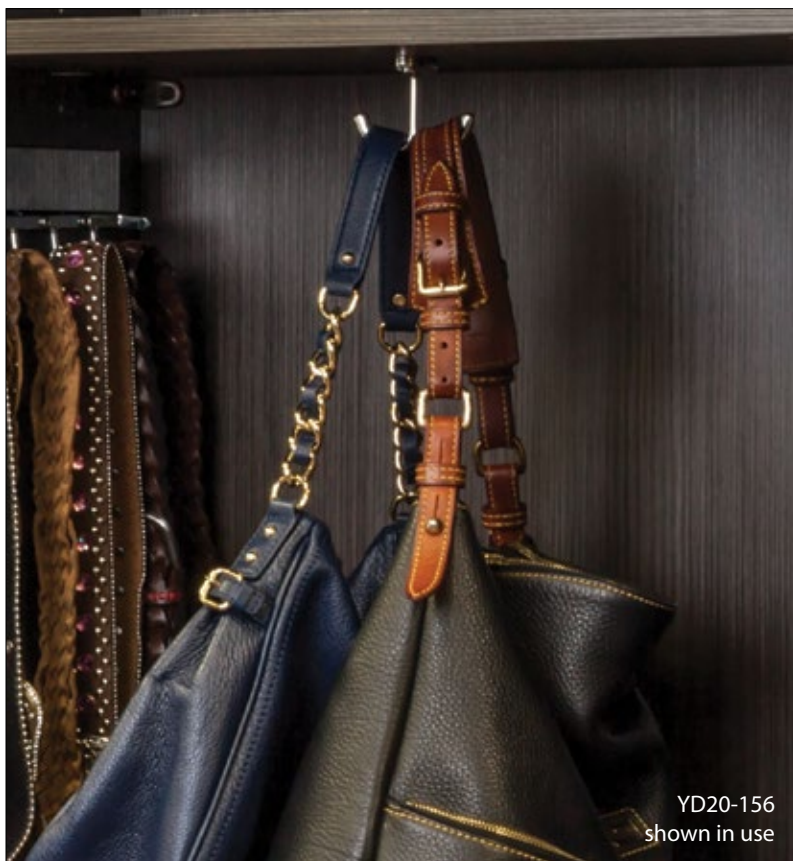



Decorative Hooks

All Hardware Resources hooks are:

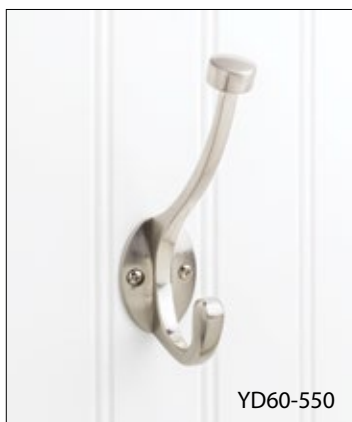
- Made to Last – Manufactured from zinc die-cast and weight tested to hold up to 35 lb.
- Same Beautiful Finishes – Available in the same popular finishes as our Jeffrey Alexander and Elements decorative cabinet hardware for a cohesive look throughout the house.
- Lifetime Warranty – Hardware Resources believes in quality, integrity, and reliability by offering a lifetime warranty on all our hooks.

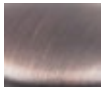

 Brushed Oil Rubbed Bronze (DBAC)

 Satin Nickel (SN)

 Polished Chrome (PC)

YD60-550

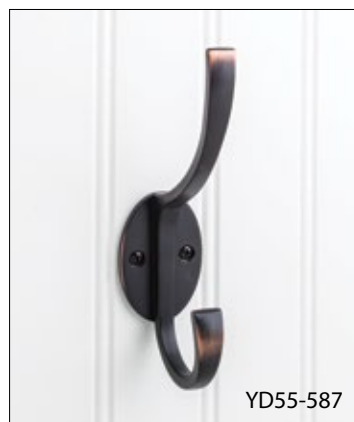

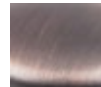
 Brushed Oil Rubbed Bronze (DBAC)

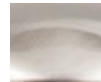
 Satin Nickel (SN)

 Polished Chrome (PC)

YD55-587

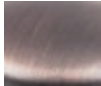

 Brushed Oil Rubbed Bronze (DBAC)

 Satin Nickel (SN)

 Polished Chrome (PC)

YD45-431

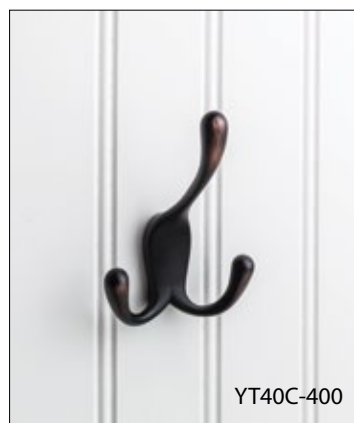

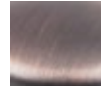
 Brushed Oil Rubbed Bronze (DBAC)

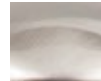
 Satin Nickel (SN)

 Polished Chrome (PC)

YT40C-400

Oval Closet Rods

Rods - 19/32" x 1-3/16" Diameter

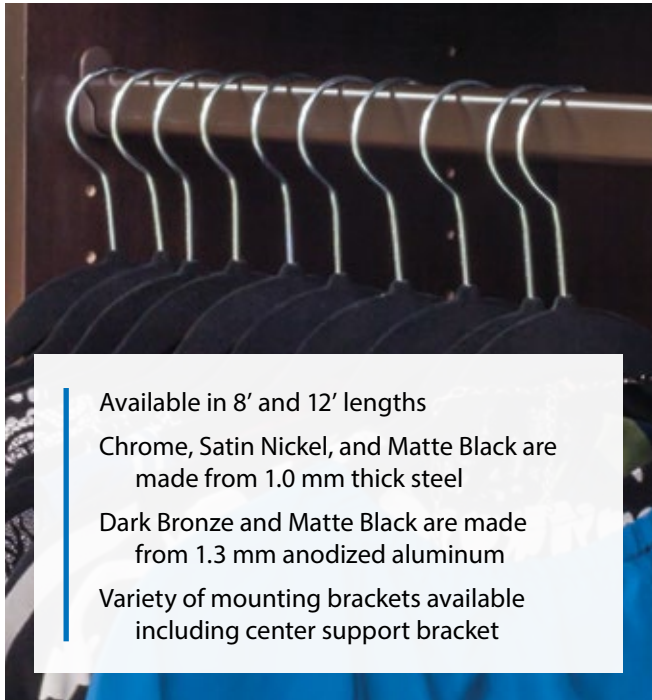

Available in 8' and 12' lengths
 Chrome, Satin Nickel, and Matte Black are made from 1.0 mm thick steel
 Dark Bronze and Matte Black are made from 1.3 mm anodized aluminum
 Variety of mounting brackets available including center support bracket

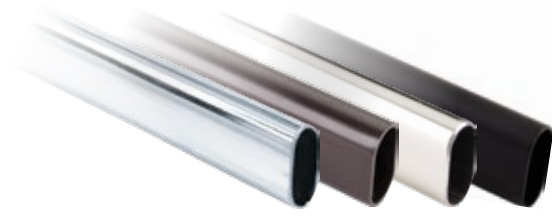

	8' Oval Rod	12' Oval Rod
Dimensions	19/32" x 1-3/16" x 8' CH & SN 1.0 mm Thick ORB 1.3 mm Thick	19/32" x 1-3/16" x 12' CH 1.0 mm Thick ORB 1.3 mm Thick
Chrome STEEL	15302CH-2	153012CH-2
Dark Bronze ALUMINUM	15302ORB-2	153012ORB-2
Satin Nickel STEEL	15302SN-2	
Matte Black NEW STEEL	15302-MB	153012-MB
Matte Black NEW ALUMINUM	15302MB-A	

10 pcs/ctn*

10 pcs/ctn*

*NO BROKEN CARTONS. FULL CARTONS ONLY.

Shelf & Rod Support Bracket

Heavy-duty 1" wide steel design
 Supports up to 150 lb. per bracket
 Designed for use with Hardware Resources 15 mm x 30 mm Oval Closet Rods.
 8' and 12' rods available in several finishes and materials (see table above for details)
 10-3/4" overall height x 11-3/4" overall depth (11" interior bracket depth) x 1" wide
 Screws included: 2 pcs #8 x 2" pan head for wall installation and #8 x 5/8" pan head to secure shelf



Dimensions	1" W x 11-3/4" D x 10-3/4" H
Weight Capacity	150 lb.
Chrome STEEL	1530CH
Dark Bronze STEEL	1530ORB
Satin Nickel STEEL	1530SN
Matte Black NEW STEEL	1530MB
Screws included: 2pcs #8 x 2"; #8 x 5/8"	

2 pcs/box
 20 pcs/ctn

Oval Closet Rods



Support Brackets



Knock-in Mounting Bracket



Screw-in Mounting Bracket



Center Support Bracket

Dimensions	5 mm Diameter Posts 32 mm Center to Center 1 Hole for Extra Screw	22 mm Center to Center Holes	28 mm Center to Center Holes 3" Overall Height
Chrome	M7160	M7175	M7190
Dark Bronze	M7160-ORB	M7175-ORB	M7190-ORB
Satin Nickel	M7160-SN	M7175-SN	M7190-SN
Matte Black NEW	M7160-MB	M7175-MB	M7190-MB
Recommended screw:	#6 flat head (optional)	#6 flat head	#6 flat head
	100 pcs/box 1,000 pcs/ctn	100 pcs/box 1,000 pcs/ctn	50 pcs/box 500 pcs/ctn

Round Closet Rods

Rods - 1-5/16" Diameter

Available in our most popular finishes: Chrome, Dark Bronze, Satin Nickel, & Matte Black

2.0 mm wall thickness

Variety of mounting brackets available including center support bracket

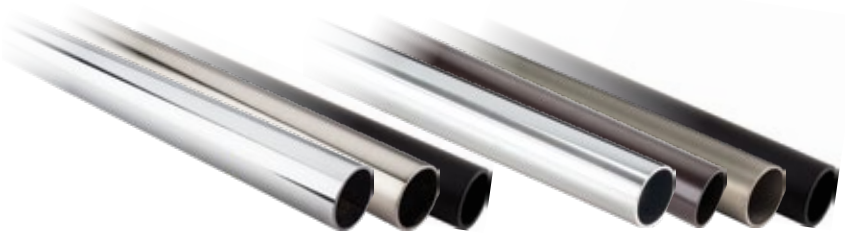
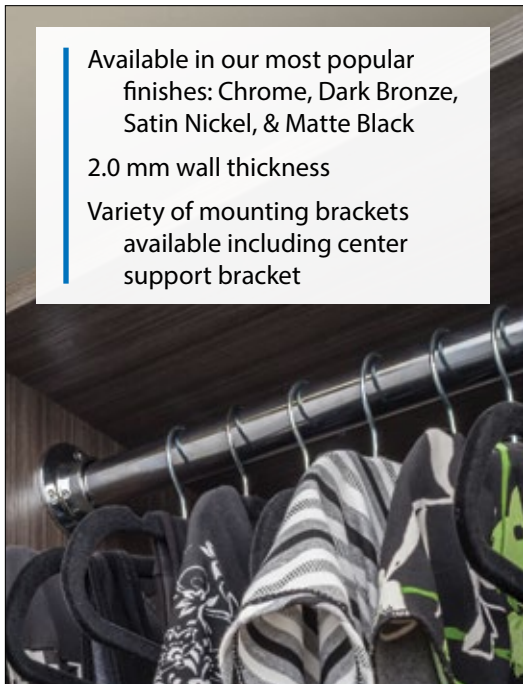

Dimensions	1-5/16" Diameter x 8' 2.0 mm Wall Thickness	1-5/16" Diameter x 8' 2.0 mm Wall Thickness
Chrome	151696CH-2	151696CH-A
Dark Bronze		151696ORB-2
Satin Nickel	151696SN-2	151696SN-A
Matte Black NEW	151696MB	151696MB-A

6 pcs/ctn*

6 pcs/ctn*

***NO BROKEN CARTONS. FULL CARTONS ONLY.**

Shelf & Rod Support Bracket

Heavy-duty 1" wide steel design

Supports up to 150 lb. per bracket

Designed for use with Hardware Resources 1-5/16" Diameter Round Closet Rods.

8' rods available in multiple finishes and materials (see table above for details)

10-7/8" overall height x 12-1/2" overall depth (10-3/4" interior bracket depth) x 1" wide

Screws included: 2 pcs #8 x 2" pan head for wall installation and #8 x 5/8" pan head to secure shelf



Dimensions	1" W x 12-1/2" D x 10-7/8" H
Weight Capacity	150 lb.
Chrome STEEL	1516CH
Dark Bronze STEEL	1516ORB
Satin Nickel STEEL	1516SN
White STEEL	1516WH
Matte Black NEW STEEL	1516MB

Screws included: 2pcs #8 x 2"; #8 x 5/8"

2 pcs/box
20 pcs/ctn

Round Closet Rods

Support Brackets

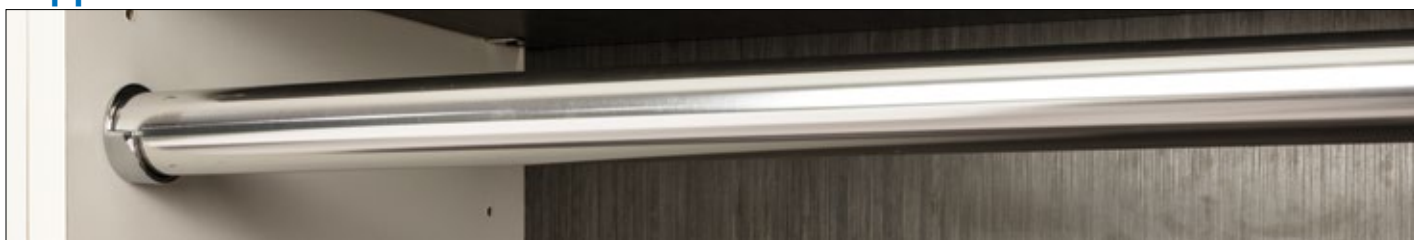

Dimensions	5 mm Diameter Posts 32 mm Center to Center 1 Hole for Extra Screw		2-3/4" Overall Width 3 Holes for Screws		2" Center to Center Holes 3" Overall Height
Chrome	M7340-CH	M7345-CH	M7350-CH	M7360-CH	M7370-CH
Dark Bronze	M7340-ORB	M7345-ORB	M7350-ORB	M7360-ORB	M7370-ORB
Satin Nickel	M7340-SN	M7345-SN	M7350-SN	M7360-SN	M7370-SN
Matte Black NEW	M7340-MB	M7345-MB	M7350-MB	M7360-MB	M7370-MB
Recommended screw:	#6 flat head (optional)	#6 flat head (optional)	screws included	screws included	#6 flat head
	50 pcs/box 200 pcs/ctn	50 pcs/box 200 pcs/ctn	20 pcs/box 200 pcs/ctn	50 pcs/box 200 pcs/ctn	50 pcs/box 200 pcs/ctn

Round Closet Rods

Rods - 1-1/16" Diameter

Woodwork Institute Approved
 Available in 8' and 12' lengths
 2.0 mm wall thickness
 Heavy-duty steel
 Variety of mounting brackets available including center support bracket



	8' Round Rod	12' Round Rod
Dimensions	1-1/16" Dia. x 8' 2.0 mm Wall Thickness	1-1/16" Dia. x 12' 2.0 mm Wall Thickness
Chrome STEEL	111696CH-2	111612CH
Matte Black NEW STEEL	111696MB	111612MB

6 pcs/ctn*

6 pcs/ctn*

*NO BROKEN CARTONS. FULL CARTONS ONLY.

Support Brackets



Open Knock-in Mounting Bracket



Open Screw-in Mounting Bracket



Closed Screw-in Mounting Bracket



Center Support Bracket

Dimensions	5 mm Diameter Posts 32 mm Center to Center 1 Hole for Extra Screw	2-5/8" Overall Length 2" Center to Center Holes	45 mm Center to Center Holes 3" Overall Height
Chrome	M7240	M7250	M7260
Matte Black NEW	M7240-MB	M7250-MB	M7260-MB
Recommended screw:	#6 flat head (optional)	screws included	screws included
	250 pcs/ctn	250 pcs/ctn	50 pcs/box 200 pcs/ctn

Round Closet Rods

Rods - 1" Diameter

- Anodized aluminum
- 1.2 mm wall thickness
- Variety of mounting brackets available including center bracket



8' Round Rod

Dimensions	1" Diameter x 8' 1.2 mm Wall Thickness
Dark Bronze ALUMINUM	100096ORB-2
Matte Black NEW ALUMINUM	100096MB-A

6 pcs/ctn*

*NO BROKEN CARTONS. FULL CARTONS ONLY.

Support Brackets



Open Knock-in
Mounting Bracket



Open Screw-in Mounting
Bracket



Closed Screw-in Mounting
Bracket



Center Support Bracket

Dimensions	5 mm Diameter Posts 32 mm Center to Center 1 Hole for Extra Screw	2-5/8" Overall Length 2" Center to Center Holes	45 mm Center to Center Holes 3" Overall Height	
Dark Bronze	M7240-ORB	M7250-ORB	M7260-ORB	M7270-ORB
Matte Black NEW	M7240-MB	M7250-MB	M7260-MB	M7270-MB
Recommended screw:	#6 flat head (optional)	screws included	screws included	#6 flat head
	250 pcs/ctn	250 pcs/ctn	250 pcs/ctn	50 pcs/box 200 pcs/ctn



Light up a closet

Add lighting in a closet to create a soft ambience that makes it easier to match clothing and accessories while getting ready. See the following pages for a selection of Task Lighting & Power products perfectly suited for closet spaces.

View the full Task Lighting & Power section on pages 493-600.

LED Linear Fixtures

Easy-to-install, fully assembled fixtures

Linear fixtures install quickly with included mounting clips and are great for illuminating shelving and cabinetry in the closet. See pages 532-553 for details.

Angled profile



Flat profile



Recessed profile



Dual-Mount Linear Fixture



LUMEN OUTPUT OPTIONS



ACCENT



STANDARD



HIGH



HIGHER

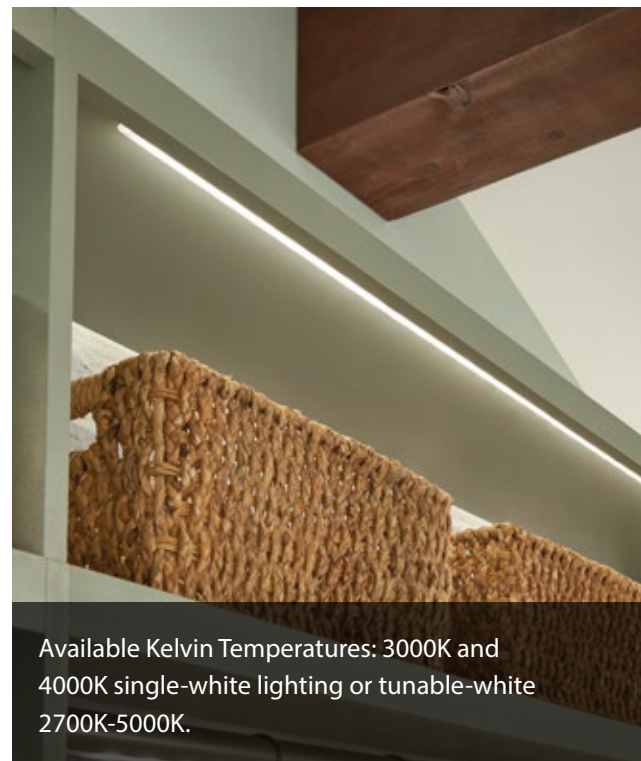

Available Kelvin Temperatures: 3000K and 4000K single-white lighting or tunable-white 2700K-5000K.



TASK™
lighting & power

LED Lighted Closet Rod

Create a luxury feel in a closet with a Lighted Closet Rod.

Fully assembled lighted closet rods are easy to install and provide high output illumination right where it's needed—on the clothing. See page 576-579 for details.

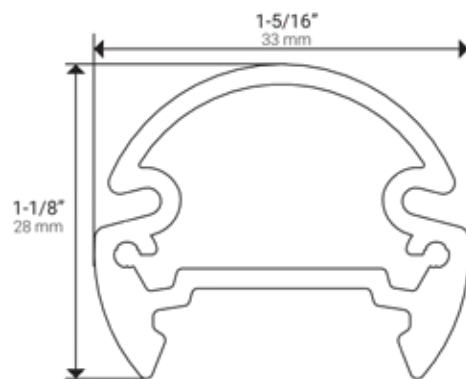

AVAILABLE FINISH OPTIONS

-  **BLACK (BK)**
-  **SATIN NICKEL (SN)**
-  **WHITE (WT)**

AVAILABLE KELVIN TEMPERATURES

-  **SOFT WHITE 3000K**
-  **COOL WHITE 4000K**
-  **TUNABLE WHITE 2700K-5000K**

ASSEMBLED
IN THE
USA

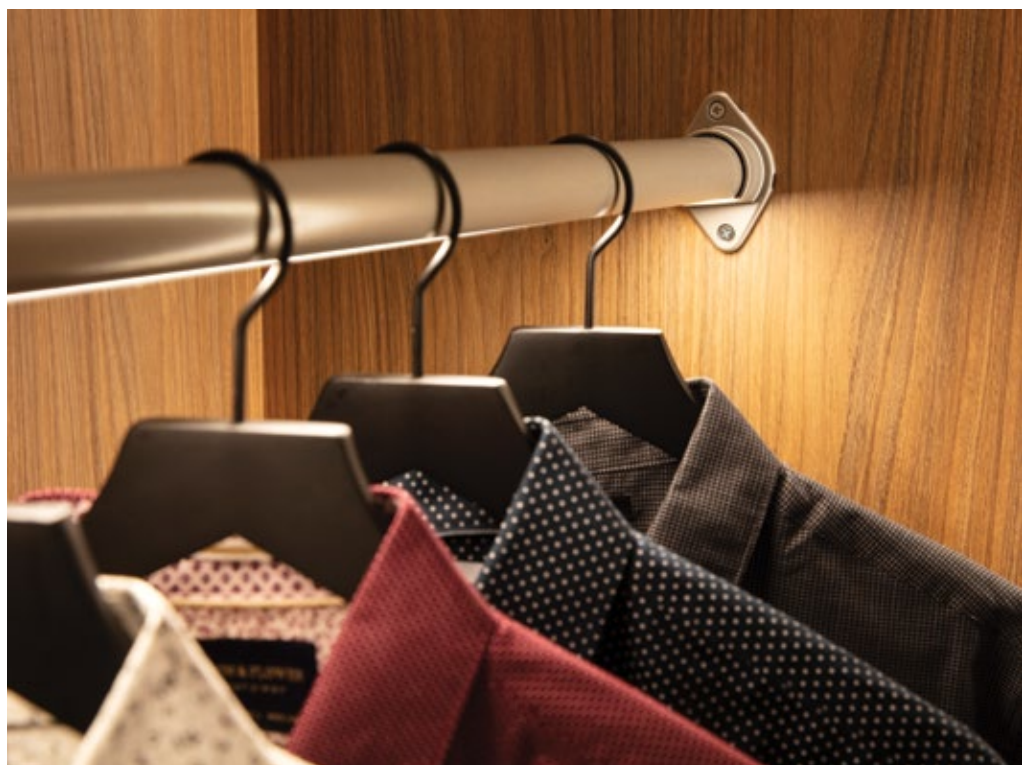



Available Kelvin Temperatures: 2700K, 3000K, 4000K, and 5000K single-white lighting or tunable-white 2700K-5000K.

LED Tape Lighting

Flexible lighting is easy to install almost anywhere lighting is needed. Available in 12V or 24V in tunable-white or single-white temperature options.

See pages 526-527 for tunable-white lighting and pages 528-529 for single-white lighting.

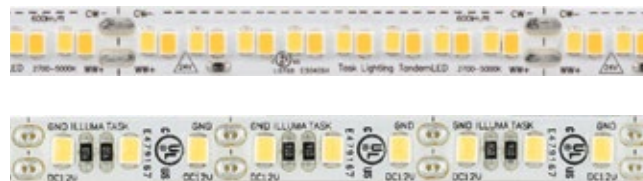

LUMEN OUTPUT OPTIONS

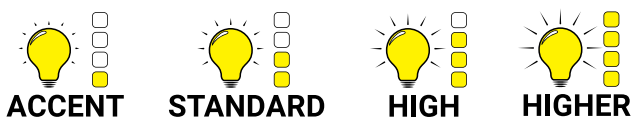

Sensor Switches

Trigger lighting without touch—sensor options available for every application. See pages 592–593.



PROXIMITY SENSOR

Place this sensor at the back of a drawer to trigger lighting when the drawer is opened and closed using infrared (IR) technology.



DOPPLER MOTION SENSOR

Great for toe kick lighting, the Doppler motion sensor switch is easy to conceal underneath or behind panels up to 2" thick (like a cabinet door). The lights come on and stay on as long as motion is detected.



DOOR SENSOR

Mount this infrared (IR) sensor just inside a cabinet or drawer, and the lights will stay on as long as the door or drawer is open.

WAV Smart Receiver

Wirelessly connect to smart home lighting hubs for app and voice control of single-white or tunable lighting. See pages 588-589.





Highlight artwork, architecture, vases, and more with puck lights.

Puck Lights

TUNABLE-WHITE SERIES

Tunable-white lighting, 190 lumens/fixture
12-volt puck light. Surface or recess mount
options. *See pages 584-585 for details.*

TUNABLE-WHITE KELVIN TEMPERATURES

For tunable-white lighting puck lights



SINGLE-WHITE SERIES

Single-white lighting, 180 lumens/fixture.
12-volt puck light. Surface or recess mount
options. *See page 584-585 for details.*

KELVIN TEMPERATURE OPTIONS

For single-white lighting puck lights



Angle Power Strip



APT SERIES (Slim Profile)

15-amp tamper-resistant single receptacles,
custom options available.



TR SERIES (Standard Profile)

20-amp tamper-resistant duplex receptacles,
large variety of custom options available.

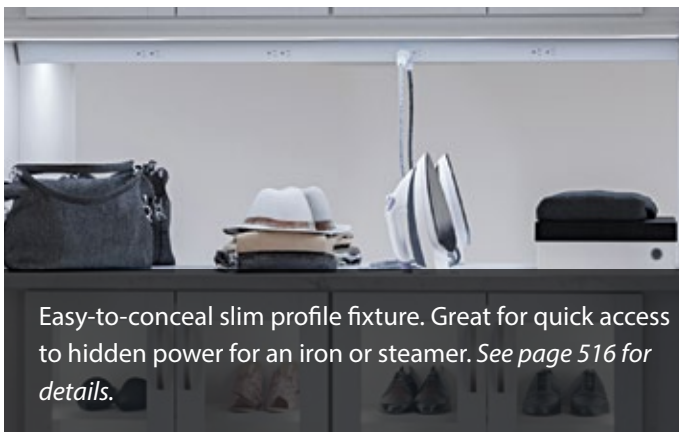

Easy-to-conceal slim profile fixture. Great for quick access
to hidden power for an iron or steamer. *See page 516 for
details.*



Customize to fit a variety of needs in any design.
Great for adding hidden power to any space.
See page 517 for details.

Dovetail Drawer Boxes for Closets



Ordering specifications:

- Standard drawer, rollout, or high-back rollout boxes
- Assembled or unassembled
- Standard heights with custom depth & width
- 1/4" standard or 1/2" bottom
- Optional universal notch for undermount slides
- Optional undermount slide clip factory installed

Easy Online Ordering & Instant Price Quoting

See website for details

Production and delivery:

- Competitive pricing
- Standard 7-day turnaround after order confirmation
- Quick-to-ship production for qualifying states

- A** 5/8" Hard Maple UV Coated or Unfinished
- B** 5/8" Aspen UV Coated
- C** 5/8" White Birch, Imported, Finger Jointed..... UV Coated
- D** 5/8" Rustic White Birch, Imported, Finger Jointed.. UV Coated
- E** 5/8" Rubberwood, Imported, Finger Jointed..... UV Coated
- F** 1/2" Birch Plywood UV Coated or Unfinished
- G** 1/2" Birch Plywood Edgebanded UV Coated



HEIGHT OPTIONS	2"	2.5"	3"	3.5"	4"	5"	6"	7"	8"	9"	9.5"	10"	11"	12"
1/2" Birch Plywood	x	x	x	x	x	x	x	x	x	x	x	x	x	x
1/2" Edgebanded Plywood		x	x		x	x	x	x	x	x		x	x	
5/8" Hardwoods	x	x	x	x	x	x	x	x	x	x	x	x	x	x
High-Back (all species)							x	x	x	x	x	x	x	x

*All high-back drawers will have a 3" front and a scoop cutout on the front face. 6" minimum height.

SIZING	Min. Depth	Max. Depth	Min. Width (without clips)	Min. Width (with clips)	Max. Width	Min. Height
Standard Drawer						
5/8" Material	7"	51"	6"	See table below	51"	2"
1/2" Material	7"	51"	6"	See table below	51"	2"
Rollout Drawer						
5/8" Material	7"	51"	6"	See table below	51"	2"
1/2" Material	7"	51"	6"	See table below	51"	2"
High-Back Rollout						
5/8" Material	12"	51"	5-1/2"	See table below	51"	6"
1/2" Material	12"	51"	5-1/2"	See table below	51"	6"

MIN. BOX WIDTH WITH UNDERMOUNT (See clip details on pages 28-29)

	US-CLIP2ND-XX	US-CLIP-2W	US-CLIP-NR	USCLIP500-2-XX
5/8" Material	7.25"	6.25"	4.875"	8.25"
1/2" Material	7"	6"	4.5"	8"

#6 x 5/8" pan head screw recommended for installation.

Drawer boxes are cut and assembled in the USA by Hardware Resources. Hard Maple and Aspen are North American hardwoods. White Birch, Rustic White Birch, and Rubberwood are imported A/B grade hardwood, laminated & finger jointed. Birch plywood is Carb Compliant 9-ply high density plywood with no internal voids. UV cured coating is 100% solid and contains no VOC. Each UV coated piece is double coated to ensure a lasting finish.

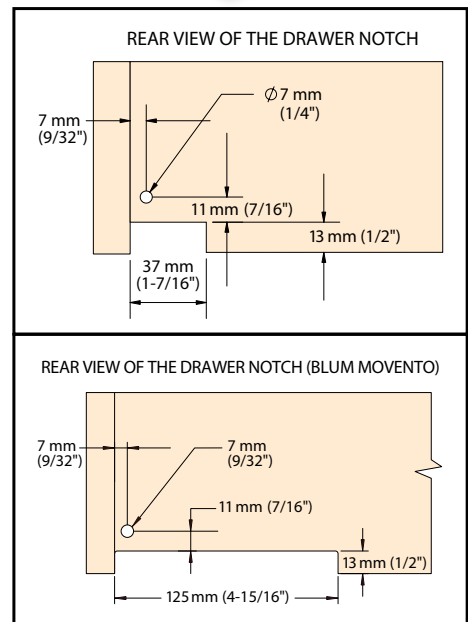



Dovetail Drawer Boxes for Closets

Closet Organizers

Rollouts & High-Back Rollouts

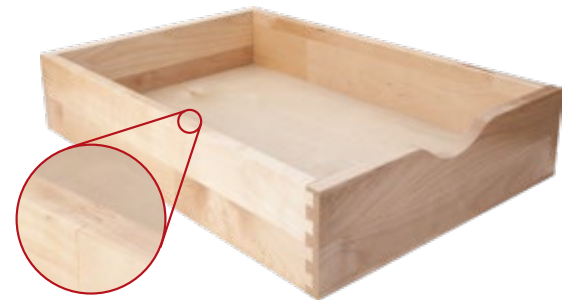

Finger joints may be visible on top edge of box for White Birch



High-Back Rollout (minimum 6" height)

Complimentary High Definition Laser Engraving on Hardwood Boxes

- Upcharge per box for plywood
- Simply provide a high-resolution file of your logo. We'll do the rest!
- Accepted file types are EPS, AI, PDF, PSD, JPEG, TIFF
- Maximum logo size is 1-1/2" tall x 6" long
- Minimum box height for engraving is 3", minimum depth is 8"
- Not available on high-back rollouts or boxes over 24" deep
- Placed on the front left inside edge of the box
- One logo per customer - logos are kept on file for future orders
- *Don't have a logo? Choose from our preselected fonts to customize your company name*



Shelf Supports: Angled

5 mm Pin Diameter

Solid steel construction

3/4" long arm

Available in carton of 1,000 pcs.



Standard With 1/8" Hole With Brown Sleeve With White Sleeve With Clear Sleeve With Diamond Hole

Antique Brass	1706AB	1707AB	1708AB			
Antique Copper		1707AC	1708AC			1710AC
Black		1707BLK				
Bright Nickel	1706BN	1707BN	1708BN	1708WBN	1708CBN	1710BN
Polished Brass	1706PB	1707PB				
	1,000 pcs/ctn*	1,000 pcs/ctn*	1,000 pcs/ctn*	1,000 pcs/ctn*	1,000 pcs/ctn*	1,000 pcs/ctn*

**NO BROKEN CARTONS. FULL CARTONS ONLY.*

1/4" Pin Diameter

Solid steel construction

3/4" long arm

Available in carton of 1,000 pcs.



Standard With 1/8" Hole With Brown Sleeve With Brown Sleeve & 7/8" Long Arm

Antique Brass	1609AB	1610AB		
Antique Copper		1610AC	1611AC	1915AC
Bright Nickel	1609BN	1610BN		
Polished Brass		1610PB		
	1,000 pcs/ctn*	1,000 pcs/ctn*	1,000 pcs/ctn*	1,000 pcs/ctn*

**NO BROKEN CARTONS. FULL CARTONS ONLY.*

Shelf Supports: Spoon

3 mm Pin Diameter



Spoon

Bright Nickel	1103BN
	1,000 pcs/box*
	10,000 pcs/ctn

*NO BROKEN BOXES. FULL BOXES ONLY.

Solid steel construction

Available in boxes of 1,000 pcs. and 10,000 pcs. master carton

5 mm Pin Diameter



Spoon



Spoon with Anti-Slide Barb



Grommet 5.5 mm drill Ø

Antique Brass	1306AB		1283AB
Antique Copper	1306AC		
Black	1306BLK		1283BLK
Bright Nickel	1306BN	1306BN-2	1283BN
Polished Brass	1306PB		1283PB
	1,000 pcs/box*	1,000 pcs/box*	1,000 pcs/box*
	6,000 pcs/ctn	6,000 pcs/ctn	5,000 pcs/ctn

*NO BROKEN BOXES. FULL BOXES ONLY.

Solid steel construction

Anti-slide barb cuts into shelf and prevents shelf movement (1306BN-2)

Supports available in boxes of 1,000 pcs. and 6,000 pcs. master carton

Grommets available in boxes of 1,000 pcs. and 5,000 pcs. master carton

1/4" Pin Diameter



Spoon



Grommet 7.5 mm drill Ø

Antique Brass	1206AB	1284AB
Antique Copper	1206AC	
Black	1206BLK	1284BLK
Bright Nickel	1206BN	1284BN
Polished Brass	1206PB	1284PB
	1,000 pcs/box*	1,000 pcs/box*
	6,000 pcs/ctn	5,000 pcs/ctn

*NO BROKEN BOXES. FULL BOXES ONLY.

Solid steel construction

Supports available in boxes of 1,000 pcs. and 6,000 pcs. master carton

Grommets available in boxes of 1,000 pcs. and 5,000 pcs. master carton

Shelf Supports: Pins

5 mm Pins



16 mm Duplo 24 mm Straight 30 mm Straight 45 mm Straight

	16 mm Duplo	24 mm Straight	30 mm Straight	45 mm Straight
Antique Copper				
Bright Nickel		1402BN	418BN	1400BN
Zinc	1401ZN	1402ZN		
	1,000 pcs/ctn*	1,000 pcs/ctn*	1,000 pcs/ctn*	1,000 pcs/ctn*

*NO BROKEN CARTONS. FULL CARTONS ONLY.

Solid steel construction

Available in carton of 1,000 pcs.

Zinc Supports - 5 mm Pin



Support with 5 mm Shelf Hold Pin

Zinc	1545ZN
	1,000 pcs/box*
	5,000 pcs/ctn

*NO BROKEN BOXES. FULL BOXES ONLY.

Solid zinc die cast construction

Available in boxes of 1,000 pcs. and 5,000 pcs. master carton

Plastic Supports - 5 mm Pin



Support

Almond	1438ALM-K 100 per bag
Brown	1438BRN-K 100 per bag
Clear	1438CL-K 100 per bag
White	1438WH-K 100 per bag

1000pcs/box

Synthetic injection molded plastic with steel pin

Each item contains a bag of 100 supports

Shelf Supports: Locks

Plastic Shelf Lock



Highly durable synthetic plastic construction
Available in a variety of pin diameters and shelf thickness combinations

	5 mm Pin 1/2" Shelf	5 mm Pin 5/8" Shelf	5 mm Pin 3/4" Shelf	1/4" Pin 5/8" Shelf	1/4" Pin 3/4" Shelf
Clear	7703CL-K	7704CL	7705CL	8704CL-K	8705CL-K
	1,750 pcs/box* 3,500 pcs/ctn	2,000 pcs/box* 4,000 pcs/ctn	2,500 pcs/box* 5,000 pcs/ctn	1,750 pcs/box* 3,500 pcs/ctn	1,750 pcs/box* 3,500 pcs/ctn

**NO BROKEN BOXES. FULL BOXES ONLY.*

Heavy-Duty Plastic Shelf Lock



	5 mm Double Pin 3/4" or 1" Shelf
Clear	7706CL
	2,000 pcs/ctn*

**NO BROKEN CARTONS. FULL CARTONS ONLY.*

500 lb. weight rating per set of 4
Highly durable synthetic plastic construction
Fits 3/4" or 1" shelf thickness
Two pins are 32 mm spaced
ANSI/BHMA A156.9-2003 Grade 1

Shelf Supports: Standards & Clips

Standards & Clips

Single track standards fit in 5/8" wide groove
 Standards quickly install using nails or screws (not included)
 Available in a variety of sizes which can also be cut to length
 Clips snap into place in 3/8" increments for a secure fit and can be easily removed and reattached



	<i>Standard Clip Builder Pack</i>	<i>Standard Clip Retail Pack</i>	<i>48" Standard</i>	<i>60" Standard</i>	<i>72" Standard</i>
Brass		1460BR-R			
Brown	1460AC	1460AC-R	TRK01-48BRN	TRK01-60BRN	TRK01-72BRN
Nickel/Zinc	1460NI	1460ZN-R	TRK01-48ZN	TRK01-60ZN	TRK01-72ZN
White	1460WH	1460WH-R	TRK01-48WH	TRK01-60WH	TRK01-72WH
	1,000 pcs/ctn*	20 pcs/pack 100 pks/ctn	20 pcs/ctn*	20 pcs/ctn*	20 pcs/ctn*

**NO BROKEN CARTONS. FULL CARTONS ONLY.*

Shelf Supports: Utility Bracket

Heavy-Duty Shelf Utility Bracket

Extra heavy-duty 1-1/4" wide steel design – supports up to 1200 lb. per pair

Thick white painted finish is durable and rust resistant

Supports shelving in a variety of residential and commercial environments: closets, garages, utility rooms, tool sheds, and laundry rooms

Also a perfect support for countertops

14" overall height x 21-1/4" overall depth

#10 x 3" pan head screws recommended for wall installation (sold separately)



Shelf Utility Bracket

Dimensions	1-1/4" W x 21-1/4" D x 14" H
Weight Capacity	600 lb.

White 1421WH

Recommended screw:	#10 pan head
---------------------------	---------------------

2 pcs/box
10 pcs/ctn

**NO BROKEN CARTONS. FULL CARTONS ONLY.*

You Buy. You Try. You Decide.

Place a Trial Order for any new-to-you cabinet organizer products and try them out. If you're not satisfied we'll take them back. Guaranteed!

How the Trial Order program works

1. Place a Trial Order for any cabinet organizers. Trial Orders can be combined with a regular order. We pay the freight on Trial Orders.
2. Test the products risk-free.
3. If you're not completely satisfied, call us. We'll give you immediate full credit on the Trial Order purchase. We'll arrange for the products to be picked up later – no need to save the original packaging, ship them back, etc. We make it easy. We would appreciate hearing your observations on the products.



How to order

1. Place an order with your local sales rep or call **800-463-0660**
2. Use code **TRIAL-CABINETORG** for the Trial Order products



Hardware Resources believes in quality, integrity, and reliability. We uphold the highest standards of service and responsibility in the industry.

As such, Hardware Resources warrants all cabinet and closet organizers against defects in material and workmanship as long as the original consumer purchaser owns the products, if the original consumer purchased the products from an authorized distributor of Hardware Resources. Hardware Resources cannot guarantee the quality or condition of products from distributors who do not agree to meet our high standards, and therefore, no warranty is provided for products from unauthorized sellers.

If the finish of any of these items tarnishes, corrodes, rusts, begins to chip or rub off or has any other defect, Hardware Resources will send to the original purchaser, a new replacement product of the same or comparable style and quality at no charge. If a replacement is no longer available, Hardware Resources will refund to the original purchaser, the current wholesale value of the item.

This warranty is a warranty of replacement only. Hardware Resources specifically does not warrant removal of the product nor installation of replacement new product. This warranty does not apply when the item has been tampered with, misused, improperly installed, altered from the original form, or damaged through improper cleaning, abuse or accident.

In the unlikely event that a defective cabinet or closet organizer is encountered, please contact Customer Service at 800.463.0660. Please be able to provide a brief description and photographs of the defect.

Task Lighting & Power

TABLE OF CONTENTS



About Task Lighting & Power 494

Design Services 496

Resources for Lighting and Power 500

Power Products

■ **Lighted Power Strip Fixtures** 506

 Lighted Power Strip (Tunable-White RM Series) 508

 Lighted Power Strip (RM Series) 510

 Lighted Power Strip (DV Series) 512

■ **Angle Power Strip Fixtures** 514

 Angle Power Strip (APT Series) 516

 Angle Power Strip (TR Series) 517

 Angle Power Strip (TR-USB Series) 518

 Angle Power Strip (TRS Series) 519

LED Lighting Products

■ LED Tape Lighting 524

■ LED Linear Fixtures 532

■ LED Cut-to-Length Program 554

■ LED Tape Lighting Kits 560

■ Specialty Lighting 574

■ LED Lighting Accessories 586

 Samples and Display Rebate 598

 Trial Order and Warranty 599

■ Tunable-White Lighting products are identified with an orange market on the side of the page.

Scan the QR code to view the full Task Lighting & Power catalog



Design Services/Technical Support:
866.848.9094 | DesignAndSupport@TaskLighting.com



Industry leader since 1985

Founded in 1985, Task Lighting & Power, a market leader in the development of power and lighting solutions for the kitchen and bath industry for over 35 years, is dedicated to providing quality lighting and power products for the residential and commercial building industry. From the company's manufacturing and design center in Kearney, Nebraska, Task Lighting & Power has developed products that are EASY to install and operate.

Products made easy

Task Lighting & Power makes it easy to add LED lighting and hidden power fixtures to your kitchen, bath, closet, laundry, or other cabinetry project. Our products will complement your design, adding functionality without taking away from the beauty.



PATENT

High-Quality innovation

Our products are professional-grade and designed by our US-based product team. We know cabinetry, and are constantly looking for ways to make lighting and power easy to add to any cabinet. Our innovation is evident by our many patented features that make our products easier to incorporate into cabinetry plans, easier to install, and easier to use. Our Angle Power Strip and Lighted Power Strip Fixtures are assembled in our Kearney, Nebraska, factory to ensure the highest quality.

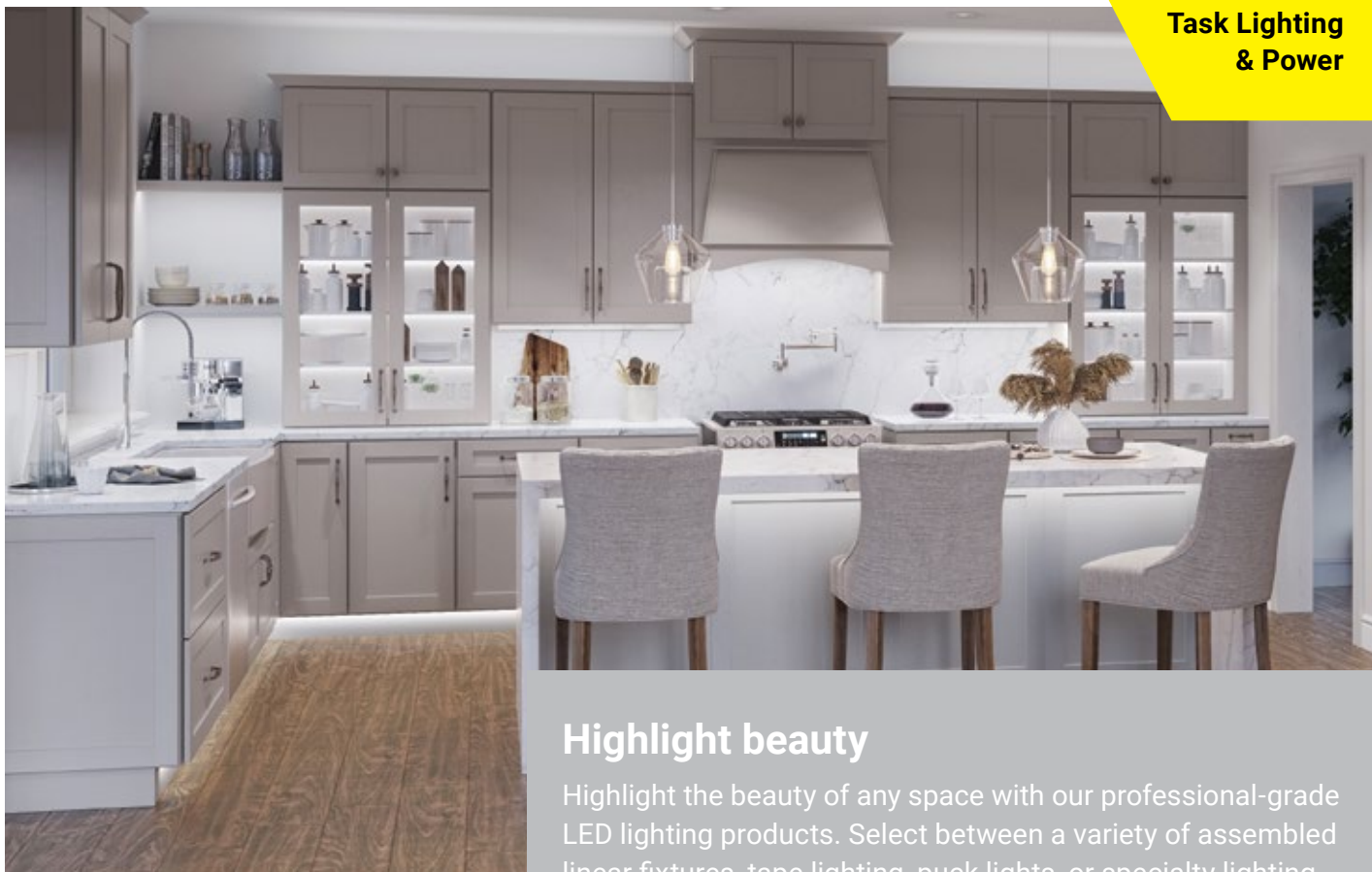

Highlight beauty

Highlight the beauty of any space with our professional-grade LED lighting products. Select between a variety of assembled linear fixtures, tape lighting, puck lights, or specialty lighting to show your designs in the best light.

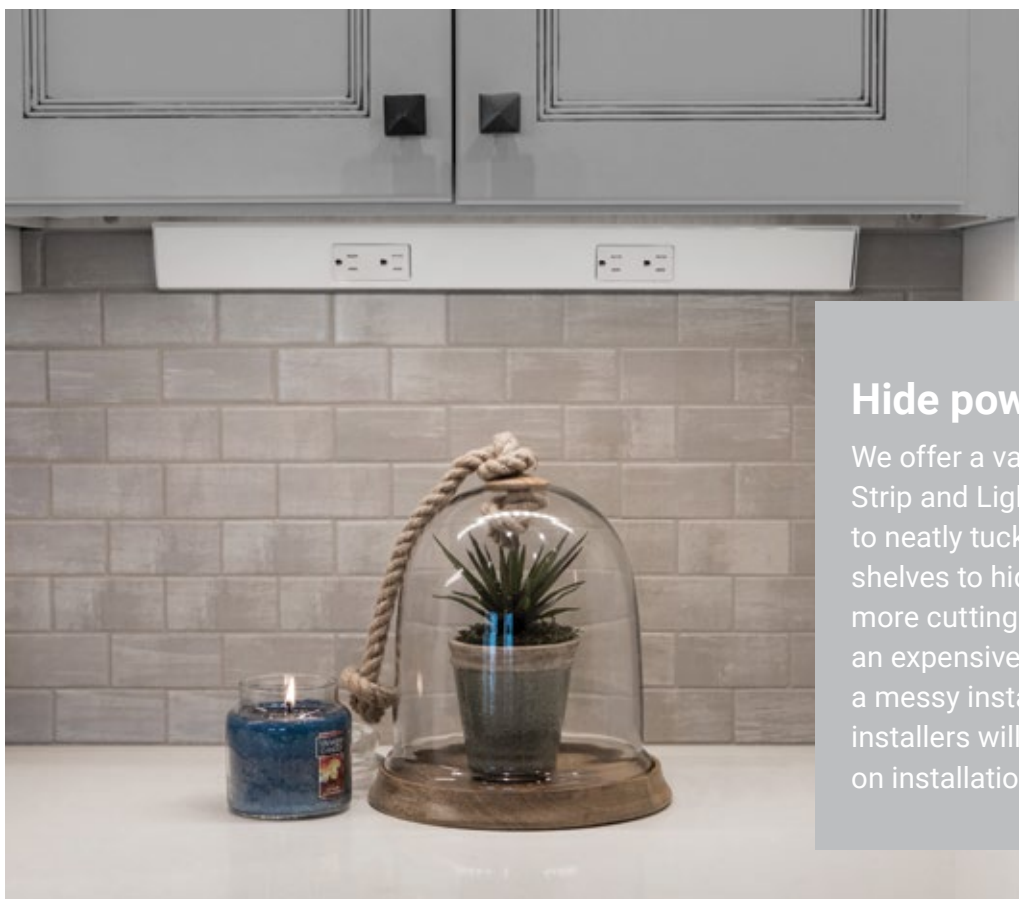

Hide power

We offer a variety of Angle Power Strip and Lighted Power Strip Fixtures to neatly tuck up under cabinets and shelves to hide outlets and switches. No more cutting unsightly receptacles into an expensive backsplash or dealing with a messy installation. Electricians and tile installers will thank you for time saved on installation.

Adding LED lighting and power is easy

Submit a CAD drawing, sketch, elevation, and/or photograph with measurements, and our experienced in-house Design Services Team will return a recommended lighting and/or power design layout and parts list.



Need a quick quote?

Scan the QR code to fill out the Customer Quote form and receive a quote back from one of our Design Services team members.



Scan to fill out the
Customer Quote Form
<https://delivr.com/2smah>

Don't know where to start?

Our dedicated (and free!) Design Services Team is available to help you with technical support, product questions, layout suggestions, and advice on the best products for your project. Call **866-848-9094** or e-mail **DesignAndSupport@TaskLighting.com**.

With our In-House Design Services Team

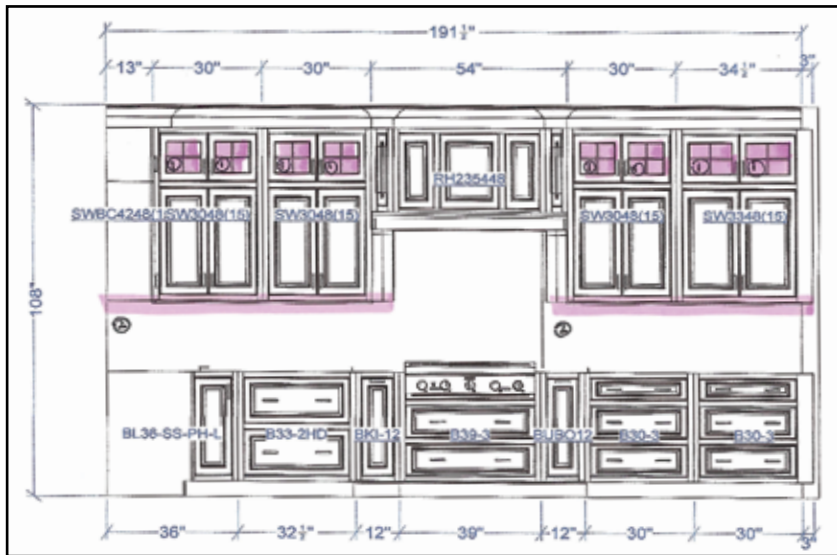

What you provide

Submit the project to the in-house Design Services team at DesignAndSupport@TaskLighting.com



What we provide

Based on the project, the Design Services team will produce a professional layout with an included parts list. When you're ready to place the order, simply let your Design Services representative know or email your order to DesignAndSupport@TaskLighting.com

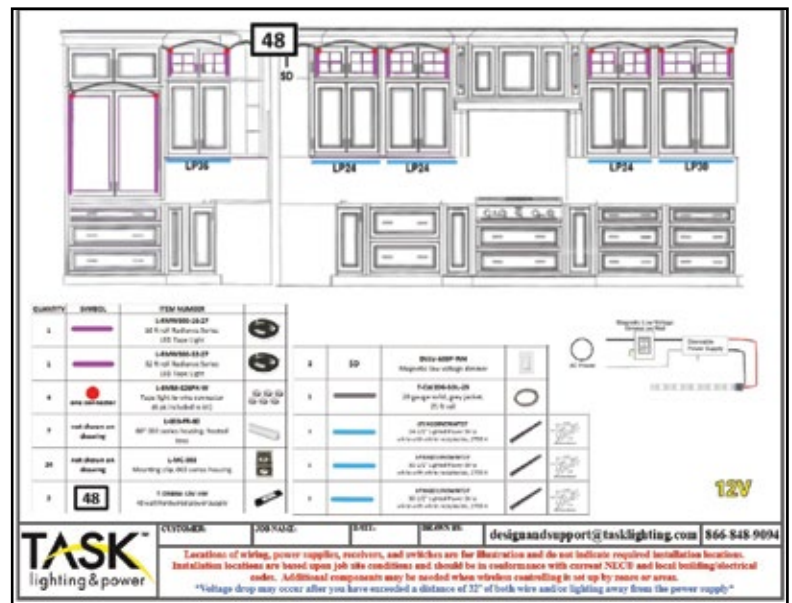

Final installation photo based on layout by Design Services

Have technical questions?

If at any point during the installation you have a technical question, give us a call for complimentary assistance.

Design Services—always friendly, always free.

Lighting and Power Made Easy

with our in-house Design Services Team

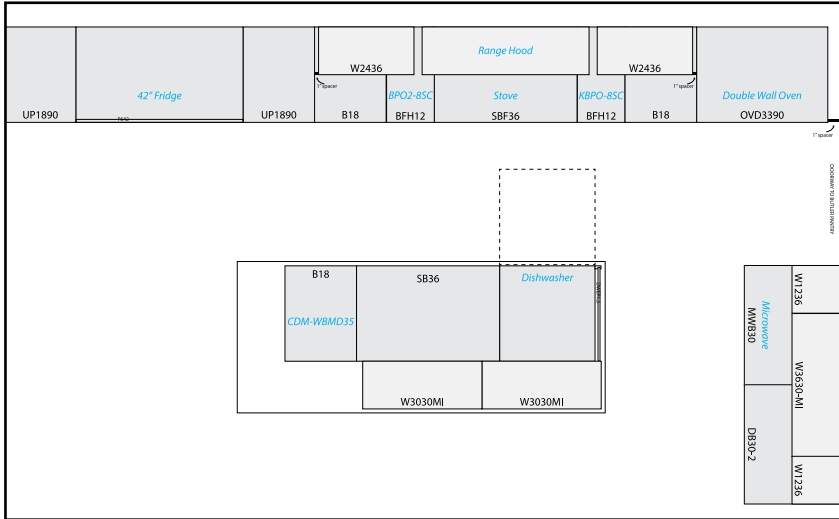

Example of layout submitted to team

Floor plan from customer submitted to Design Services.

Layout returned from the Design Services team

A recommended layout and parts list to take the guesswork out of lighting and power

hardware resources
P. O. Box 72430
4319 Mariena
Bossier City, LA 71111
Ph: 318/742-0660
Fax: 318/742-9513

QUOTE
Sales Order 42058438
Order Date 09/08/2023
Printed By MBOC
Page 1 of 2
www.hardwareresources.com

Customer: MKT901
Marketing/Trade Show Account
4310 Mariena St
Bossier City, LA 71111-7503
800/463-0660

Ship To: VERIFY SHIP TO ADDRESS
VERIFY SHIP TO ADDRESS
VERIFY SHIP TO ADDRESS
BATON ROUGE, LA 70821

P. O. Number	Salesperson	Ship Via	F.O.B.	Payment Terms
RENDERING	HA	FDX	DESTINATION	2% 10, NET 30 DAYS

Stock Items									
Line	Ship Location	Item	Est Ship Date	Description	Reference	Qty	UOM	Unit Price	Total
1	KRN	LT2PQ24V30-08W	09/15/2023	26-15/16" 300 Lm/Ft TW Flat-Fits WC30"-521Lm-003-24V-08W		4.00	EA		
2	KRN	LT6PQ24V12-04W	09/15/2023	9-7/16" Dual Mount Flat fits WC12-600 Lm/Ft-24V-04watt-TW 27		2.00	EA		
3	KRN	LT6PQ24V24-09W	09/15/2023	71-3/4" Dual Mount Flat fits WC24-600 Lm/Ft-24V-09watt-TW 27		2.00	EA		
4	KRN	LT6PQ24V36-14W	09/15/2023	34-1/16" Dual Mount Flat fits WC36-600 Lm/Ft-24V-14watt-TW 2		1.00	EA		
5	KRN	L-TR00-16-24VNW	09/15/2023	16 Ft 300 Lm/Ft TW Tape Light-24V		2.00	EA		
6	KRN	T-24V-24W-P1	09/15/2023	24V DC Plug-in power supply, 24 watt		1.00	EA		
7	KRN	T-24V-60W-P1	09/15/2023	24V DC Plug-in power supply, 60 watt		3.00	EA		
8	KRN	T-TWAV-WR-120	09/15/2023	WRV Smart Receiver for single color or Tandem CCT tape light		5.00	EA		
9	KRN	T-CH20G-STR-60	09/15/2023	WIRE-20 AWG-STRAINED-WHITE JACKET-LUL LISTED-50 FEET		1.00	EA		

Easy to order

Convert this to an order, and call back at any time during or after the installation for expert technical support.

Your FREE Design Assistant for LED Lighting and Power Layouts



Knowledgeable in-house staff

Our seasoned Design Services and Technical Support team in our Kearney, Nebraska, facility is always on hand to support you with layout designs and technical guidance from new construction or remodeling a home.

A Wide Variety of Resources

Videos that teach and sell

Visit www.Vimeo.com/TaskLighting to explore our videos on installation, product benefits, and more!



View our Videos

Scan to go to our Vimeo page
<https://delivr.com/2j2z3>



Videos for Your Customer

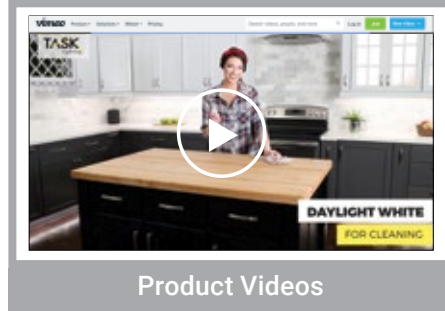

Product Videos

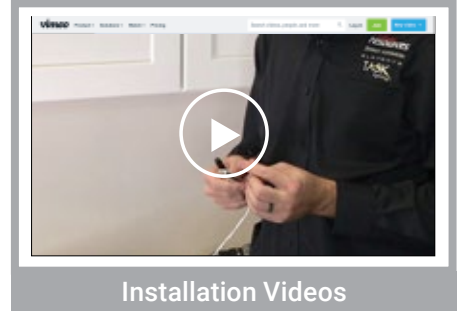

Installation Videos

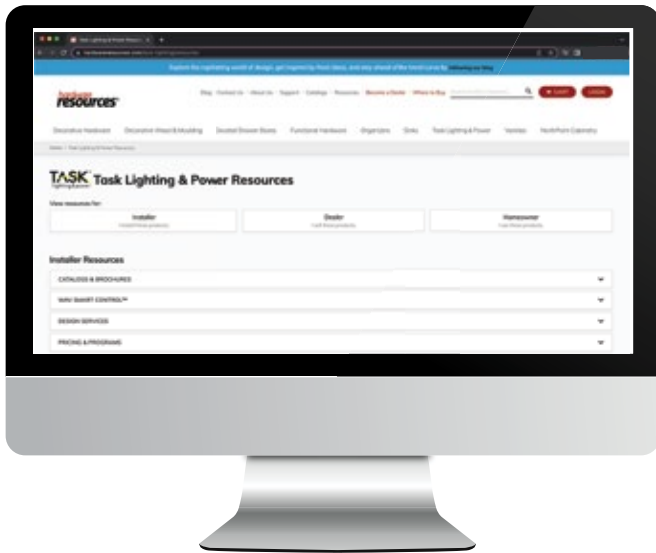

Resources made easy

We've made it easy to find additional information in the resources section of the Task Lighting & Power website. Simply scroll to the bottom of the homepage or visit www.TaskLighting.com/Resources to find digital versions of the catalog, selection guides, and more.

Follow Task Lighting & Power on social media

To find inspiration on including Task Lighting & Power products in a project, view our social media accounts, or visit www.TaskLighting.com

Connect with us on Social Media:





Highlight your designs with LED lighting

Task Lighting
& Power

Task Lighting & Power products are the perfect solution to easily enhance the atmosphere of any space by adding lighting and power.

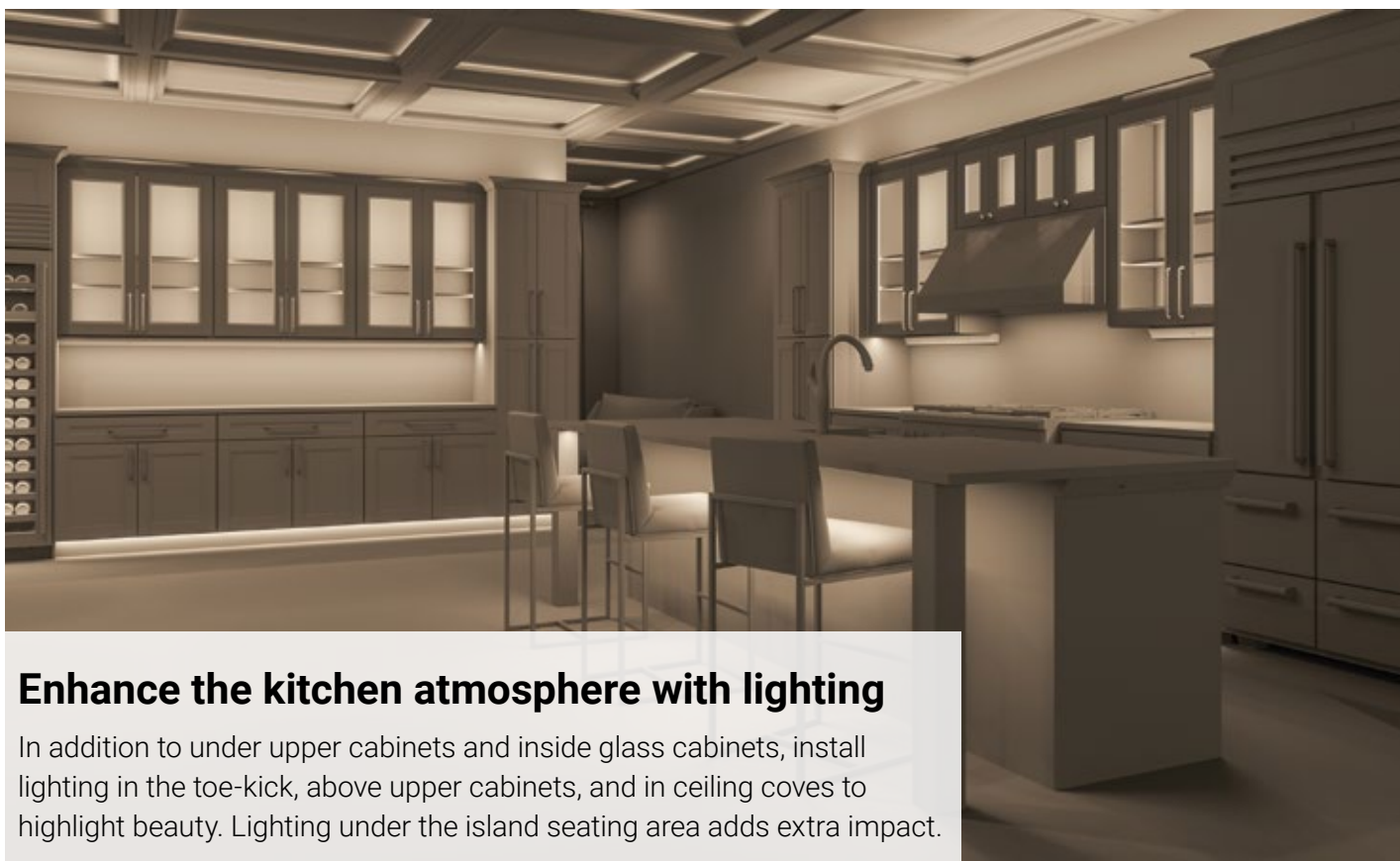

Enhance the kitchen atmosphere with lighting

In addition to under upper cabinets and inside glass cabinets, install lighting in the toe-kick, above upper cabinets, and in ceiling coves to highlight beauty. Lighting under the island seating area adds extra impact.

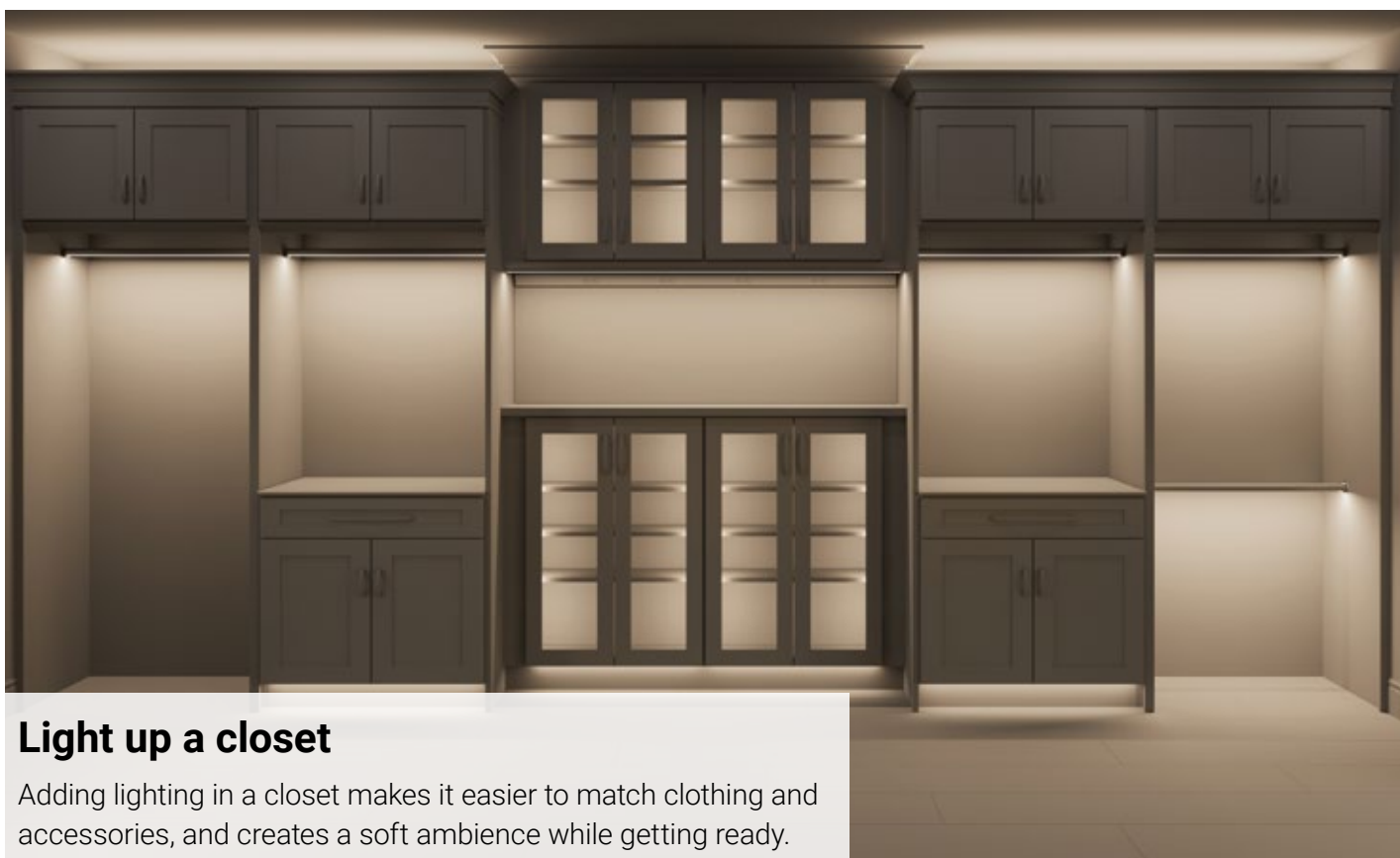

Light up a closet

Adding lighting in a closet makes it easier to match clothing and accessories, and creates a soft ambience while getting ready.

A Wide Variety of LED Lighting and



LED Lighted Power Strip

Highlight a surface of any space while adding more outlets to keep a clutter-free and well-lit workspace.

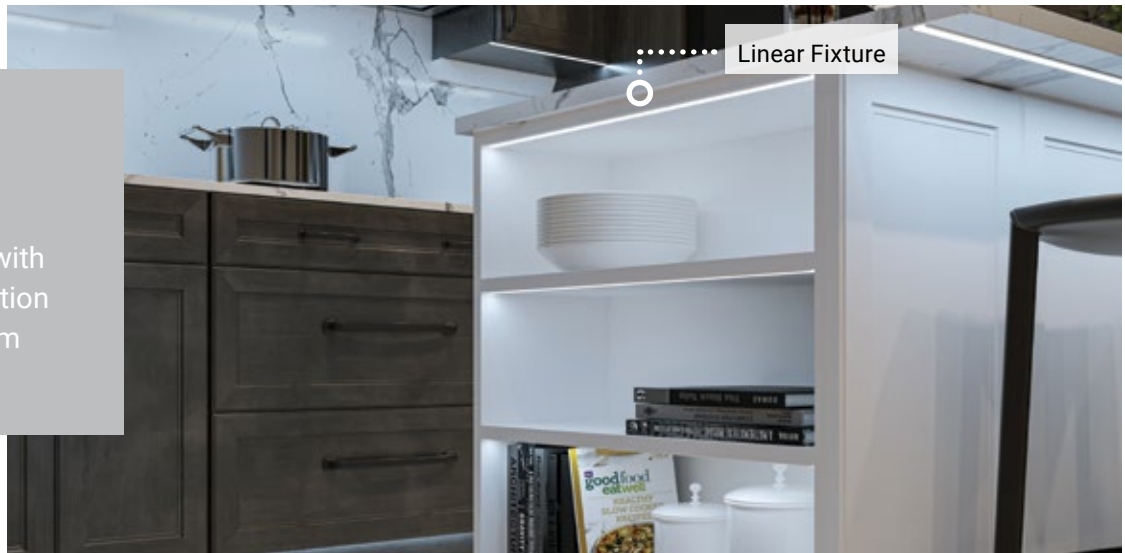

LED Linear Fixtures

Elevate any design with a sleek lighting solution that provides uniform illumination.



LED Lighted Closet Rods

Improve the clothing selection experience with additional light and a touch of modern elegance.

Power Products for any Space

Angle Power Strip

Optimize outlets where they're needed most while keeping them hidden from eyesight for an elevated, functional workspace.



LED Tape Lighting

A flexible, versatile lighting solution to fit in tight spaces, around curves, or hard-to-reach areas to enhance the aesthetic of a space.



LED Specialty Lighting

Add creative lighting to designs by backlighting a countertop or highlighting architectural features.

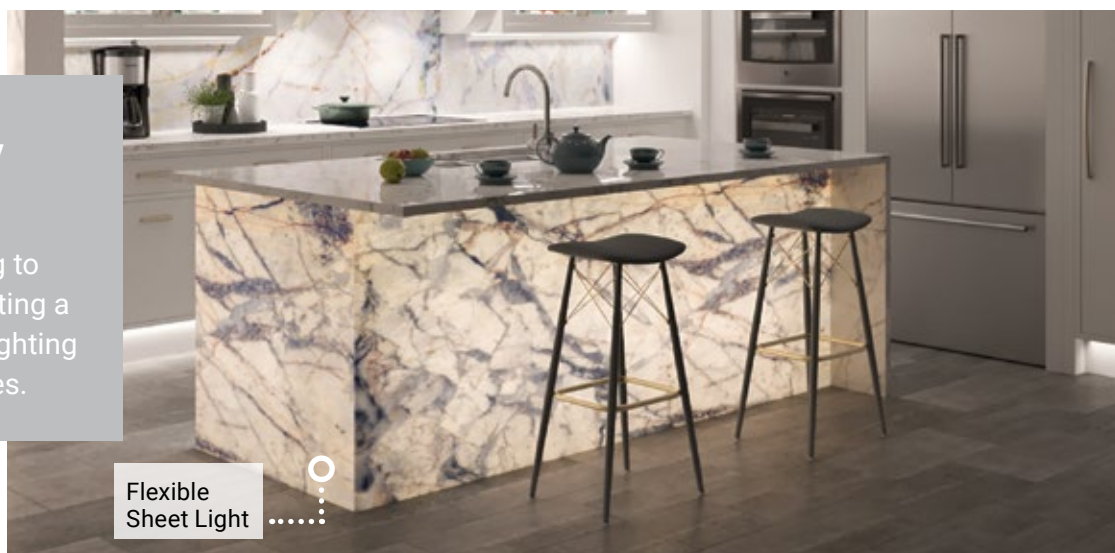

Flexible Sheet Light

New and Updated Products

Premium Flat Linear Fixtures and Profiles

The new Premium Flat Linear Fixture is available in tunable-white and single-white lighting options and is an exceptional fixture for those looking for high-quality bright output and stylish undercabinet lighting. Turn to page 534 for a linear fixture to improve the look and feel of any space.

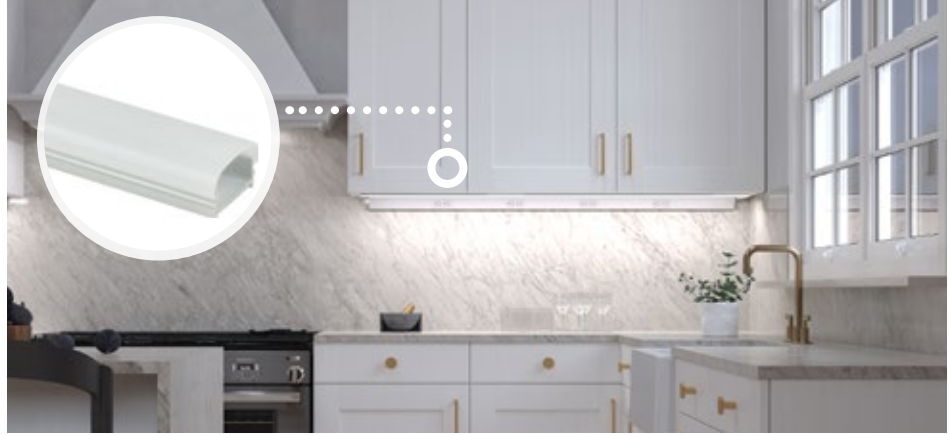

Dual-Mount Linear Fixtures and Profiles

Available in Tunable-White and Single-White light options, the Dual-Mount Linear Fixtures are perfect for surface or recess mounted lighting. Find more on page 538 for a versatile linear fixture to elevate any space with functionality, style, and innovation.

Lighted Closet Rods

Create a luxurious closet experience with our upgraded Lighted Closet Rod. Available in Tunable-White and Single-White lighting options, it's easy to find a fixture that combines practicality and aesthetics. Turn to page 576 to find more information.

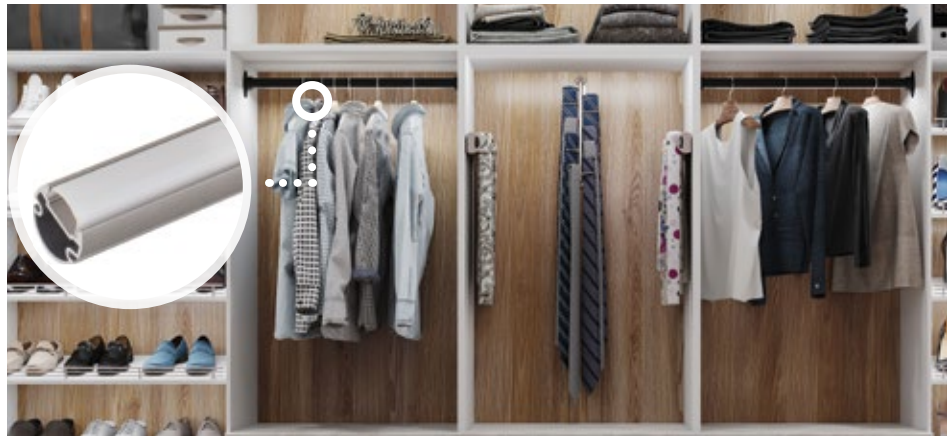

Flexible Sheet Light

Customize the design of any room with the upgraded Flexible Sheet Light. New connectors make this light easy-to-install under a countertop, behind a backsplash, or anywhere flexible lighting is desired. See page 580 to see how easy it is to add creative lighting to any design.



Guarantee the best light for any design

Tunable-White lighting featuring TandemLED™ is an adaptable lighting option that lets you select the Kelvin temperature AFTER the cabinets and lighting are installed. Set the Kelvin temperature to match the color scheme of any room or mirror natural lighting to synchronize with the body's circadian rhythm throughout the day.



Warm White 2700K



Soft White 3000K



Cool White 4000K



Daylight White 5000K

Single-White Lighting Options

While Tunable-White Lighting is the best option to make matching existing lighting and creating a personalized lighting experience easy, we do offer single-white lighting in four standard options.



Warm White 2700K

Warm White 2700K

This temperature complements brown woods or warm colors. Copper, gold, brass, and bronze hardware pair nicely with this temperature.



Soft White 3000K

Soft White 3000K

Select this temperature to complement natural wood, warm grey, and ivory. Bronze, satin nickel, and gold hardware pair nicely with this temperature.



Cool White 4000K

Cool White 4000K

This temperature goes well with white, green, and blue colors. Satin nickel, gunmetal, and pewter hardware pair nicely with this temperature.



Daylight White 5000K

Daylight White 5000K

This temperature goes well with stark white or bluish rooms. Satin nickel, chrome, and black hardware pair nicely with this temperature.

Lighted Power Strip Fixtures

Highlight Beauty. Hide Power.

Add a patented Lighted Power Strip underneath a cabinet to illuminate the countertop and backsplash while eliminating unsightly power outlets from a beautiful backsplash. Electricians love the quick installation—attach in place with screws and connect power.





Tune lighting to Warm White to relax in the evening.

Highlight your design in the best light

Choose the Kelvin temperature after installation to match the homeowner's preference and give them the freedom to adjust the temperature to match their activities throughout the day with tunable-white Lighted Power Strip fixtures.



Set lighting to Daylight White while cooking and cleaning.

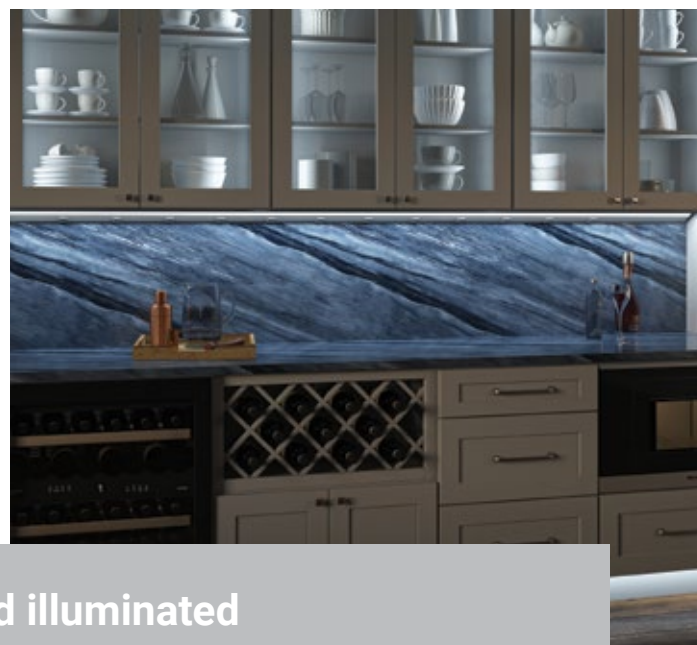
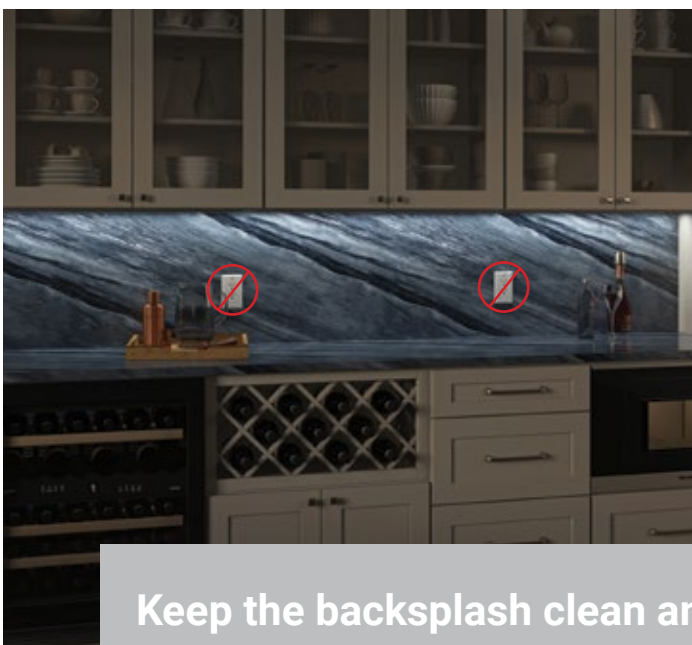

Keep the backsplash clean and illuminated

Don't interrupt your beautiful backsplash with ugly outlets. Install a Lighted Power Strip fixture to add more outlets that are tucked up out of sight for when you need them most.



Lighted Power Strip

Tunable-White Lighting with TandemLED™
Technology RM Series (Remote Power Supply)

Perfect for adding light and power with one fixture; select the white light color after the lighting is installed; smart home compatible

24 in. fixture shown in Bronze
with Black receptacles
LP24-T6R12W-BBZ

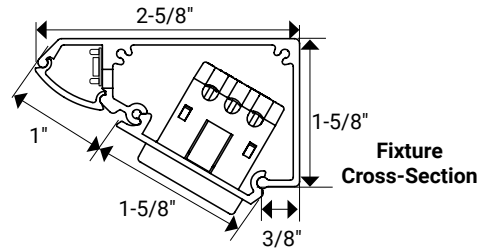

About the Product

- Tunable-White lighting from Warm White to Daylight White and all shades of white in between
- Tune the white light and adjust the brightness separately with required wired, wireless controller, (order separately) or smart home device (not included).
- Low profile: 1-5/8"
- Remote power supply (for LED lighting) order separately—reduce total cost by powering multiple fixtures with one power supply. Find more about power supplies on pages 586
- Standard fixture lengths and configurations on facing page; custom options available including rocker switches
- Never dim receptacles. Bring in dedicated low voltage power from the remote power supply to the lighting
- Easy installation—ships fully assembled and includes wood screws and wall anchors
- No Ultraviolet (UV) or Infrared (IR)
- Compatible with WAV Smart Control™ devices
- 50,000 hour LED life at 70% lumen maintenance
- UL listed

Available Finish Options with Coordinating Receptacle Color

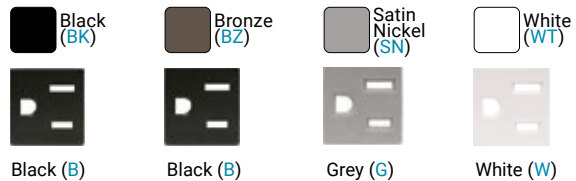

Tunable-White Kelvin Temperatures

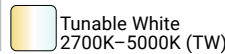

Lumen Output



LED Specifications

LED Beam Angle 120°

Accessories

Find installation components starting on page 586

Applications

- Under cabinet
- Under fixed shelving
- Office cubicles
- Shops and garages



Design By: Beth Simmons at
Kitchen Masters, Lakewood, CO



Lighted Power Strip

Single-white lighting RM Series (Remote Power Supply)

Perfect for adding light and power with one fixture; install multiple fixtures in a row connected to one power supply

24 in. fixture shown in Black with
Black receptacles
LP24HR12NDBBK30

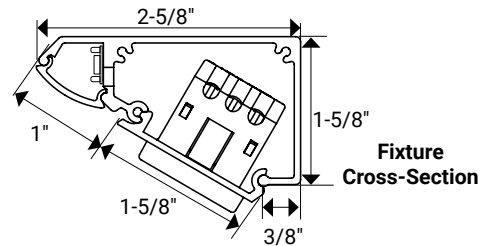

About the Product

- Low profile: 1-5/8"
- Remote power supply (for LED lighting) order separately—reduce total cost by powering multiple fixtures with one power supply. Find more about power supplies on pages 586
- Standard fixture lengths and configurations on facing page; custom options available including rocker switches
- Never dim receptacles, bring in dedicated low voltage power from the remote power supply to the lighting
- Easy installation—ships fully assembled and includes wood screws and wall anchors
- No Ultraviolet (UV) or Infrared (IR)
- Compatible with WAV Smart Control™ devices
- 50,000 hour LED life at 70% lumen maintenance
- UL listed

Applications

- Under cabinet
- Under fixed shelving
- Office cubicles
- Shops and garages

Available Finish Options with Coordinating Receptacle Color

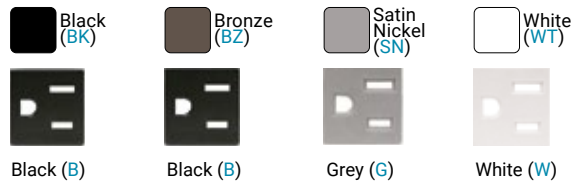

Kelvin Temperature Options



Lumen Output



LED Specifications

LED Beam Angle 120°

Accessories

Find installation components starting on page 586

LED Lighted Power Strip

Single-White RM Series (Remote Power Supply)

120V Ordering Information

600 Lumens/ft. 120-volt Receptacles; 12-volt LED Lighting

Kelvin Temperature	Length	Total Lumens	Total Watts	Number of Receptacles	Part Number
2700K, 3000K, 4000K, 5000K	10-1/2" (267 mm)	500	3	1	LP10HR3NDColorFinishTemp
2700K, 3000K, 4000K, 5000K	12-1/2" (317 mm)	600	4	2	LP12HR6NDColorFinishTemp
2700K, 3000K, 4000K, 5000K	18-1/2" (470 mm)	900	6	2	LP18HR9NDColorFinishTemp
2700K, 3000K, 4000K, 5000K	24-1/2" (622 mm)	1200	8	4	LP24HR12NDColorFinishTemp
2700K, 3000K, 4000K, 5000K	30-1/2" (775 mm)	1500	10	4	LP30HR15NDColorFinishTemp
2700K, 3000K, 4000K, 5000K	36-1/2" (927 mm)	1800	12	4	LP36HR18NDColorFinishTemp
2700K, 3000K, 4000K, 5000K	42-1/2" (1080 mm)	2100	10	5	LP42HR21NDColorFinishTemp
2700K, 3000K, 4000K, 5000K	48-1/2" (1232 mm)	2400	12	5	LP48HR24NDColorFinishTemp
2700K, 3000K, 4000K, 5000K	60-1/2" (1537 mm)	3000	10	7	LP60HR30NDColorFinishTemp
2700K, 3000K, 4000K, 5000K	72-1/2" (1842 mm)	3600	12	8	LP72HR36NDColorFinishTemp

Blue indicates dealer choice: Color indicates receptacle color, Finish indicates fixture finish color, and Temp indicates Kelvin temperature
 LP10HR3NDGSN30 (Example part number for LPS RM Series, with Grey receptacles, Satin Nickel finish, in 3000K Kelvin temperature)

Custom Options Available

LP-R-Color-15A 15-amp tamper-resistant receptacles to add to custom fixtures. Available in Black (B), Grey (G), or White (W).

APS-Switch-Color Rocker switch to add to custom fixtures. Available in Black (B), Grey (G), or White (W).



Scan to view receptacle placement
<https://delivr.com/2uq7k>



Scan to view power supply selection guide
<https://delivr.com/268v6>

Fixtures Shown in Standard Receptacle Color and Finish Option

LP18HR9NDBBK

Black finish, black receptacles



LP18HR9NDBBZ

Bronze finish, black receptacles



LP18HR9NDGSN

Satin Nickel finish, grey receptacles



LP18HR9NDWWT

White finish, white receptacles

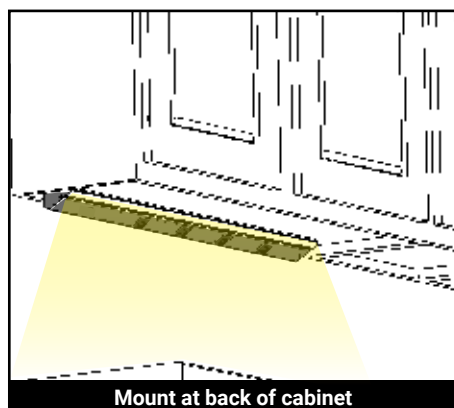

How to Build a Part Number

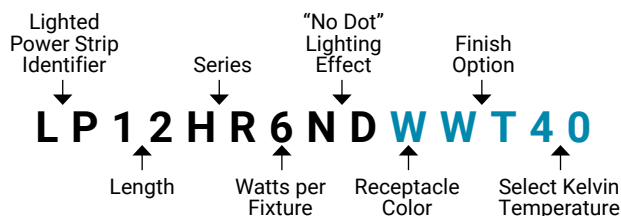



Design By: Designs by Ebony LLC

Lighted Power Strip

Single-white lighting DV Series (Built-In Power Supply)

Perfect for adding light and power with one fixture; made easy-to-install with a power supply included in the fixture

24 in. fixture shown in Satin Nickel with Grey receptacles
LP24QD8NDGSN30

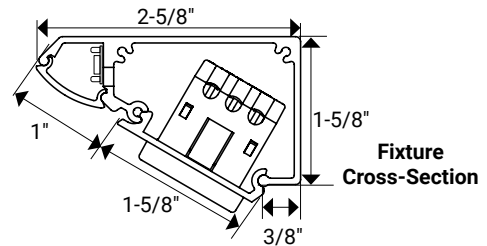

About the Product

- Low profile: 1-5/8"
- Built-in power supply—direct replacement for a stand-alone fluorescent light that also provides power
- Standard fixture lengths and configurations on facing page; switch included on fixture
- Never dim receptacles, dedicated 120V circuit can be run from wall dimmer and connected directly to integrated power supply
- Easy installation—ships fully assembled and includes wood screws and wall anchors
- No Ultraviolet (UV) or Infrared (IR)
- Compatible with WAV Smart Control™ devices
- 50,000 hour LED life at 70% lumen maintenance
- UL listed

Applications

- Under cabinet
- Under fixed shelving
- Office cubicles
- Shops and garages

Available Finish Options with Coordinating Receptacle Color

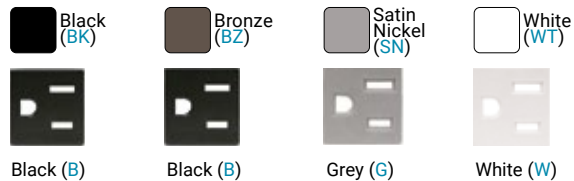

Kelvin Temperature Options



Lumen Output



LED Specifications

LED Beam Angle 120°

Accessories

Find installation components starting on page 586

LED Lighted Power Strip

Single-White DV Series (Built-In Power Supply)

120V Ordering Information

400 Lumens/ft. 120-volt Receptacles; 12-volt LED Lighting

Kelvin Temperature	Length	Total Lumens	Total Watts	Number of Receptacles	Part Number
2700K, 3000K, 4000K, 5000K	10-1/2" (267 mm)	300	3	1	LP10QD2NDColorFinishTemp
2700K, 3000K, 4000K, 5000K	12-1/2" (317 mm)	400	4	2	LP12QD4NDColorFinishTemp
2700K, 3000K, 4000K, 5000K	18-1/2" (470 mm)	600	6	2	LP18QD6NDColorFinishTemp
2700K, 3000K, 4000K, 5000K	24-1/2" (622 mm)	800	8	4	LP24QD8NDColorFinishTemp
2700K, 3000K, 4000K, 5000K	30-1/2" (775 mm)	1000	10	4	LP30QD10NDColorFinishTemp
2700K, 3000K, 4000K, 5000K	36-1/2" (927 mm)	1200	12	4	LP36QD12NDColorFinishTemp

Blue indicates dealer choice: **Color** indicates receptacle color, **Finish** indicates fixture finish color, and **Temp** indicates Kelvin temperature
LP10QD2NDGSN30 (Example part number for LPS DV Series, with Grey receptacles, Satin Nickel finish in 3000K Kelvin temperature)



Scan to view receptacle placement

<https://delivr.com/2jnvv>

Fixtures Shown in Standard Receptacle Color and Finish Option



LP18QD6NDBBK
Black finish, black receptacles



LP18QD6NDGSN
Satin Nickel finish, grey receptacles



LP18QD6NDBBZ
Bronze finish, black receptacles



LP18QD6NDWWT
White finish, white receptacles

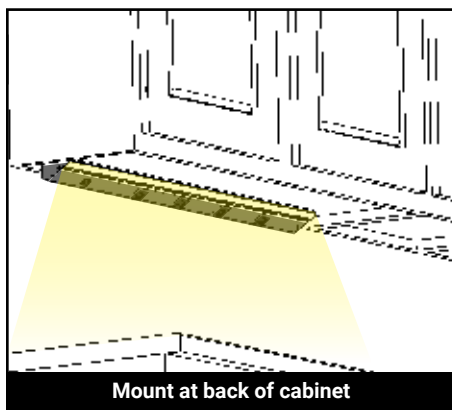

How to Build a Part Number

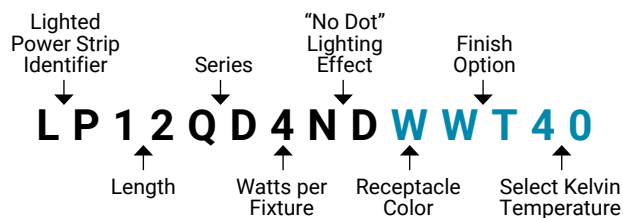

120V
Receptacles

12V
LED lighting

LED Lighting
5 YEAR
WARRANTY

ASSEMBLED
IN THE
USA

WAV
Smart Home
Compatible

UL
LISTED

Angle Power Strip Fixtures

Don't let unsightly power outlets ruin a beautiful design

Place a patented Angle Power Strip tucked up underneath a cabinet or shelf to eliminate the need to cut into a beautiful backsplash while placing power where it's needed most in kitchens, baths, offices, and laundry rooms.





At first glance, the Angle Power Strip isn't visible.

Power that disappears at eye level

Angle Power Strip fixtures are designed to tuck up underneath cabinets, providing power where it's needed most while keeping the outlets hidden from view.

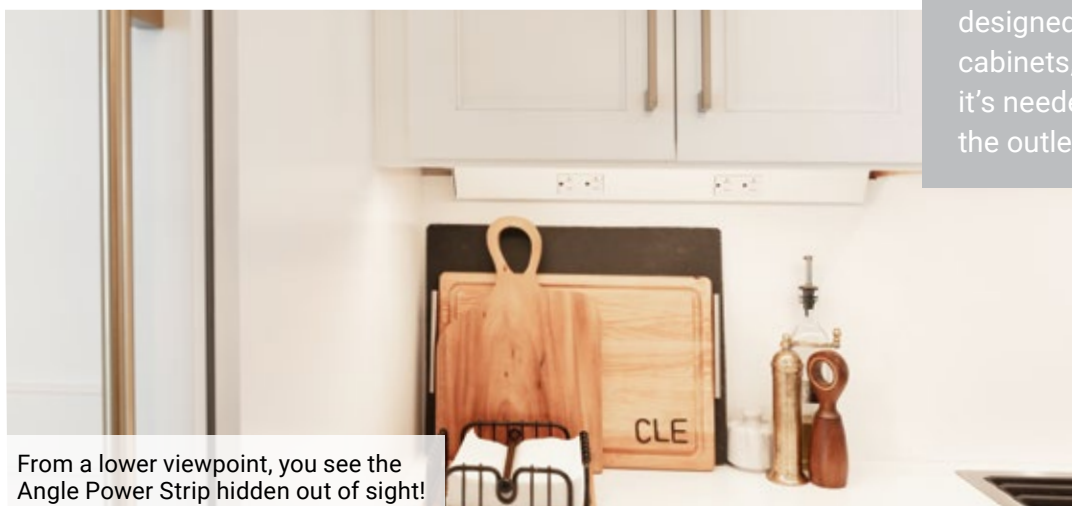

From a lower viewpoint, you see the Angle Power Strip hidden out of sight!



Preserve the beauty of the backsplash

Don't interrupt your beautiful backsplash with ugly outlets; install an Angle Power Strip fixture to add more outlets that are tucked up out of sight for when you need them most.



Angle Power Strip Slim Profile (APT Series)

Slim and concealable—15 amp single receptacles; hide power out of sight beneath cabinets with our slimmest power fixture.

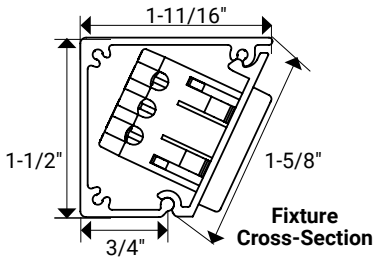

24 in. fixture shown in Satin Nickel with Grey receptacles
APT24-4G-P-SN

About the Product

- Slim profile: 1-1/2"
- 15-amp tamper-resistant single receptacles
- Available in standard and custom fixtures
- Custom options include: rocker switches, additional receptacles, and length
- Simple to install fully assembled fixture with wood screws and wall anchors (included)
- Designer finishes to blend with any décor
- UL listed

Applications

- Kitchens
- Bathrooms
- Offices and computer labs
- Shops and garages

Custom Options

APT-R-Color-15A
15-amp tamper-resistant receptacles to add to custom fixtures. Available in Black (B), Grey (G), or White (W).

APS-Switch-Color
Rocker switch to add to custom fixtures. Available in Black (B), Grey (G), or White (W).

Part Number	Length	Number of Receptacles
APT9-2Color-P-Finish*Position	9" (229 mm)	2
APT12-2Color-P-Finish*Position	12" (305 mm)	2
APT18-3Color-P-Finish*Position	18" (457 mm)	3
APT24-4Color-P-Finish	24" (610 mm)	4
APT30-4Color-P-Finish	30" (762 mm)	4
APT36-4Color-P-Finish	36" (914 mm)	4
APT42-5Color-P-Finish	42" (1067 mm)	5
APT48-5Color-P-Finish	48" (1219 mm)	5
APT60-7Color-P-Finish	60" (1524 mm)	7
APT72-8Color-P-Finish	72" (1829 mm)	8

Custom lengths, receptacle placements, and optional rocker switch placement available. Contact Design Services at 866-848-9094

*Position indicates Left (L) or Right (R) side wire entry.

Blue indicates dealer choice: Color indicates receptacle color and Finish indicates fixture finish color.

Available Finish Options with Coordinating Receptacle Color

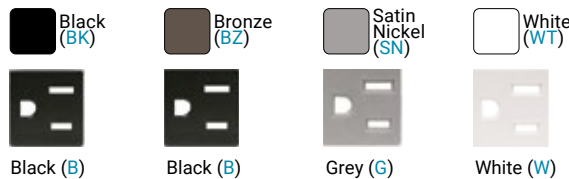

How to Build a Part Number

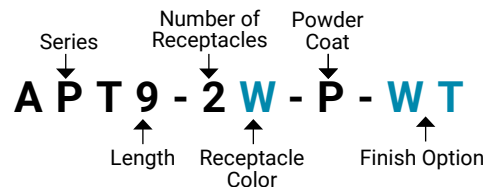

Scan to view receptacle placement
<https://delivr.com/2y3j8>





Angle Power Strip Duplex Receptacle (TR Series)

Hide power and more—20 amp duplex receptacles and a vast selection of customization options like USB and several switch combinations.

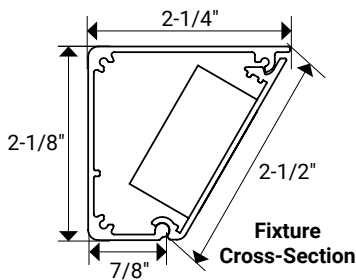

24 in. fixture shown in Satin Nickel with Grey receptacles TR24-2G-P-SN

About the Product

- Low profile: 2-1/8"
- 20-amp tamper-resistant duplex receptacles
- Available in standard and custom fixtures
- Custom options include: USB-A ports, switches, phone jacks, cable jacks, data ports, HDMI ports, and more: scan the QR code for more
- Designer finishes to blend with any décor
- UL Listed

Applications

- Kitchens
- Bathrooms
- Offices and computer labs
- Shops and garages

Part Number	Length	Number of Duplex Receptacles
TR9-1Color-P-Finish	9" (229 mm)	1
TR12-1Color-P-Finish	12" (305 mm)	1
TR18-2Color-P-Finish	18" (457 mm)	2
TR24-2Color-P-Finish	24" (610 mm)	2
TR30-2Color-P-Finish	30" (762 mm)	2
TR36-2Color-P-Finish	36" (914 mm)	2
TR42-3Color-P-Finish	42" (1067 mm)	3
TR48-3Color-P-Finish	48" (1219 mm)	3
TR60-4Color-P-Finish	60" (1524 mm)	4
TR72-4Color-P-Finish	72" (1829 mm)	4

Custom lengths, receptacle placements, and multiple custom options available. Contact Design Services at 866-848-9094

Blue indicates dealer choice: Color indicates receptacle color and Finish indicates fixture finish color.



Scan to view custom options
<https://delivr.com/2dhx7>



Scan to view receptacle placement
<https://delivr.com/29q8e>

Receptacle Color and Coordinating Finish



How To Build a Part Number

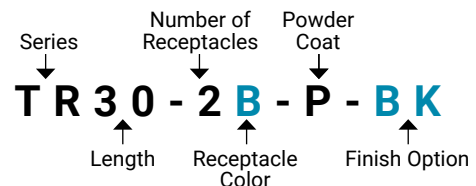

Design By: Amanda Dodd

U.S. PATENT
7,156,694

Angle Power Strip USB Included (TR-USB Series)

Hidden power with USB-A already included for quick and easy ordering without customization.

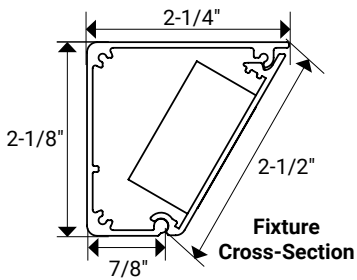

24 in. fixture shown in Satin Nickel with Grey receptacles
TRU24-2G-P-SN

About the Product

- Low profile: 2-1/8"
- 20-amp tamper-resistant duplex receptacles
- 15-amp tamper-resistant USB-A/receptacle combo device
- Available in standard fixtures only: see page 517 for TR Series for a custom fixture
- Simple to install fully assembled fixture with wood screws and wall anchors (included)
- Designer finishes to blend with any décor
- UL listed

Applications

- Kitchens
- Bathrooms
- Offices and computer labs
- Shops and garages

Part Number	Length	Number of Combo/USB Receptacles	Number of Duplex Receptacles
TRU9-1Color-P-Finish	9" (229 mm)	1	
TRU12-1Color-P-Finish	12" (305 mm)	1	
TRU18-2Color-P-Finish	18" (457 mm)	1	1
TRU24-2Color-P-Finish	24" (610 mm)	1	1
TRU30-2Color-P-Finish	30" (762 mm)	1	1
TRU36-2Color-P-Finish	36" (914 mm)	1	1
TRU42-3Color-P-Finish	42" (1067 mm)	1	2
TRU48-3Color-P-Finish	48" (1219 mm)	1	2
TRU60-4Color-P-Finish	60" (1524 mm)	1	3
TRU72-4Color-P-Finish	72" (1829 mm)	1	3

USB-A device is always positioned on the left side.

Blue indicates dealer choice: Color indicates receptacle color and Finish indicates fixture finish color.

Available Finish Options with Coordinating Receptacle Color



Grey (G)

White (W)

How to Build a Part Number

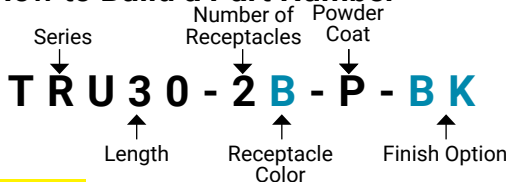

Scan to view receptacle placement

<https://delivr.com/226xgx>

120V
Receptacles

ASSEMBLED
IN THE
USA

5 YEAR
WARRANTY

UL
LISTED



Angle Power Strip Switch Included (TRS Series)

Order a standard fixture with a switch to control lights or a garbage disposal. Great for adding hidden power to any design.

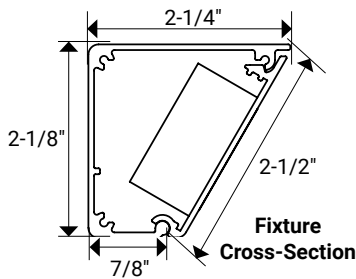

12 in. fixture shown in Bronze with Black receptacles
TRS12-1B-BZ



24 in. fixture shown in Satin Nickel with Grey receptacles
TRS24-3G-SN-RS

About The Product

- Low profile: 2-1/8"
- 20-amp tamper-resistant duplex receptacles
- 15-amp switch included on each fixture for controlling lights and/or garbage disposal
- Available in standard fixtures only: see page 517 for TR Series for a custom fixture
- Simple to install fully assembled fixture with wood screws and wall anchors (included)
- Designer finishes to blend with any décor
- UL listed

Applications

- Kitchens
- Bathrooms
- Offices and computer labs
- Shops and garages

Available Finish Options with Coordinating Receptacle Color

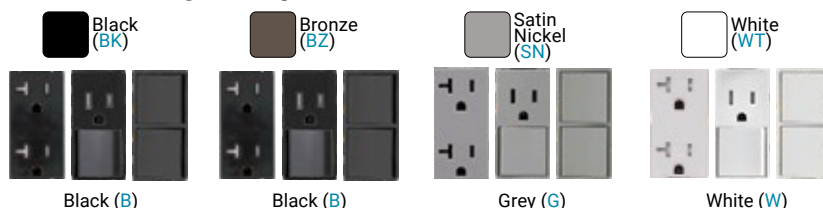

Part Number	Length	Number of Combo/Switch Receptacles	Number of Duplex Switches	Number of Duplex Receptacles
TRS9-1Color-Finish	9" (229 mm)	1		
TRS12-1Color-Finish	12" (305 mm)	1		
TRS18-2Color-Finish-Switch	18" (457 mm)		1	1
TRS24-3Color-Finish-Switch	24" (610 mm)		1	2
TRS30-3Color-Finish-Switch	30" (762 mm)		1	2
TRS36-3Color-Finish-Switch	36" (914 mm)		1	2

Switch can be located on Left Side (LS) or Right Side (RS) of 18"–36" fixtures.
Blue indicates dealer choice: Color indicates receptacle color, Finish indicates fixture finish color, and Switch indicates placement side of the switch installed.

Switch Descriptions

- TRO-CB-1P/REC-Color: Combination 15-amp single pole switch: 1/2 horsepower, 120-volt AC, 15-amp tamper-resistant receptacle
- TRO-DS-2SPS-Color: Dual 15-amp single pole switch: 1/2 horsepower at 120-volt AC. 12-amp max shared amperage between the switches

How to Build a Part Number

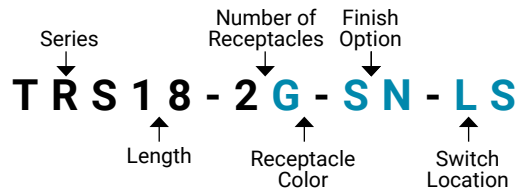

Scan to view receptacle placement
<https://delivr.com/2t7g3>



Enhanced with LED Lighting

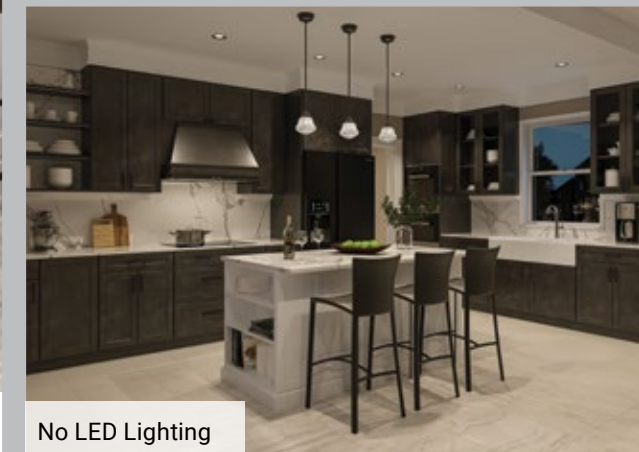

No LED Lighting

Make a statement with LED lighting

Increase the functionality in any space by adding LED lighting over high-use surfaces under cabinets. Enhance the aesthetic appeal of a space by adding lighting above cabinets to make a room feel larger, under toe-kicks to give a subtle glow, or inside cabinets to highlight decorative dinnerware.

LED Lighting made easy

Easy to Install in Any Space

Easy to order and install cut-to-length tape lighting with simple peel-and-stick application and linear fixtures sized by standard cabinet lengths with mounting clips for a snap-in installation.

Lighting Your Way

A full line of lighting options from tape lighting and linear fixtures to lighted closet rod and flexible sheet light makes it easy to find a lighting solution for any application.

Professional Quality

Products that offer exceptional color rendering of 90+ CRI for accurate color representation, options for indoor and outdoor installations, multiple lumen outputs for a variety of applications, and compatibility with multiple lighting controls, including smart home.



Tune lighting to Warm White to complement brown woods or warm colors.



Take the guesswork out of choosing the right lighting

Use tunable-white tape lighting to select the white light Kelvin temperature after the cabinets and lighting are installed to match the color scheme of a room. Choose a warm white or daylight white and any shade of white in between to enhance design elements in different ways and personalize your lighting experience throughout the day.

Set the lighting to Daylight White to enhance white or lighter colored spaces.



Tunable-White lighting makes it easy to adjust the brightness and temperature based on the time of day or activities you're doing.



Warm White 2700K

This warm light looks like sunrise and sunset, making it great for setting a cozy and relaxing atmosphere for early mornings and evenings.



Soft White 3000K

Warmer lights are easier on the eyes and are recommended for activities like reading, screentime, and entertaining.



Cool White 4000K

This temperature mimics sunlight for most of the daytime hours, making it a good all-around temperature for many activities.



Daylight White 5000K

Set the lights to this temperature for a brightly lit space while meal prepping or cleaning.



Selecting Lighting Output

Below is an example of how to layer lighting outputs for the optimal finished result

Accent Output Lighting

Create depth, highlight focal points, and evoke ambiance by adding accent output lighting to any space. Recommended for toe-kick lighting and for highlighting architectural features like coffered ceilings or beams.



Standard Output Lighting

Used for general illumination, standard output lighting is often placed above wall cabinets, under countertops in seating areas, and in closets. Standard output can also be used for general under cabinet lighting as an economical choice.

High Output Lighting

For workplaces where tasks require more light for visibility, use high output lighting to create better illumination, especially in under cabinet applications.



Higher Output Lighting

Add higher output lighting in spaces where tasks demand optimal visibility for various activities.







Layered lighting made easy

Use more than one output of light to add dramatic lighting to a room and create a beautiful, functional space.



Lighting Brightness Output Icons

The icons used to identify the classification of each lumen output are found on the product pages. The chart below breaks down suggested lumen outputs for different applications.

APPLICATION	 ACCENT 0–150 Lumens/ft	 STANDARD 151–399 Lumens/ft	 HIGH 400–599 Lumens/ft	 HIGHER 600+ Lumens/ft
Under cabinet	✓	✓	✓	✓
Interior cabinet	✓	✓	✓	
Above cabinet	✓	✓		
Toe-kick	✓			
Under island countertop	✓	✓	✓	
Fixed or floating shelves	✓	✓	✓	✓
Under floating cabinets	✓	✓		
Over sink		✓	✓	✓
Inside drawer	✓			
Stair railing (hand railing)	✓	✓		
Stair steps	✓	✓		
Cove	✓	✓	✓	
Under vanities	✓	✓		
Behind mirror	✓	✓		
Closet shelves	✓	✓	✓	

Don't know where to start?

Our dedicated (and free!) Design Services Team is available to help you with technical support, product questions, layout suggestions, and advice on the best products for your project.



Scan to fill out the Customer Quote Form
<https://delivr.com/2smah>

LED Tape Lighting

Elevate designs with LED tape lighting

Bring depth to a room by installing tape lighting to enhance architectural details, highlight decorative items, and transform any space.



Featured: 120 and 225 lumens/foot single-white LED tape lighting with LED puck lights

Create this look with 4 basic components:

LED Tape Lighting



Plug-in Power Supply

T-60W-12V-PI



Wireless Controller

T-Q-4Z-WC-RF and T-Q-WR96



Screw-down Connectors and Wire

L-EZV2-6PK-WT and T-CW20G-STR-25



LED Tape Lighting made easy

Easy to install in any space

Installation is made easy with cut-to-length, waterproof IP65 rated tape lighting with 3M™ adhesive backing for a secure installation.



Multiple options for personalized lighting

Choose Kelvin temperature, light output, length, and more, and control with wireless, wired, or smart home systems to create a personalized lighting experience in any space.

Stress free set-up

Our trained team of designers and technicians help lay out exactly what is needed without the need for pre-existing lighting knowledge.





12V and 24V LED Tape Light

Tunable-White Lighting with TandemLED™ Technology

Tunable-White Lighting suits any space thanks to its ability to change from a warm to cool shade of white and back at any time—why settle for one choice?

24-Volt, 600 Lumens/Ft.

Field cuttable approximately every 2-1/2"



24-Volt, 400 Lumens/Ft.

Field cuttable approximately every 2-1/2"



24-Volt, 300 Lumens/Ft.

Field cuttable approximately every 2-1/4"



12-Volt, 300 Lumens/Ft.

Field cuttable approximately every 1-1/8"



About The Product

- Tunable-White lighting from Warm White to Daylight White and all shades of white in between
- Tune the white light and adjust the brightness separately with required wired, wireless controller, (order separately) or smart home device (not included)
- Exceptional color rendering of 90+ CRI (Color Rendering Index)
- Dimmable (with compatible dimmer)
- WAV Smart Control™ compatible for smart home connection
- 12V or 24V power supply required (order separately)
- Aluminum housings with frosted or clear lens available for clean installation (order separately)
- No Ultraviolet (UV) or Infrared (IR)
- 3M™ 300LSE waterproof adhesive tape
- 50,000 hour LED life at 70% lumen maintenance
- UL Listed

Applications

- Under cabinet
- Interior cabinet
- Cove
- Outdoor

Tunable-White Kelvin Temperatures



Accessories

Find installation components starting on page 586



Tunable-White LED Tape Lighting

Ordering Information



24V 600 Lumens/Ft. 24-Volt LED Tape Lighting

Tape Width	Kelvin Temperature	Length	Lumens Per Foot	Watts Per Foot	IP Rating	Cutting	Part Number
10 mm	Tunable-White 2700K-5000K	16 ft.	600	5.5W (18.2/m)	IP65	Approx. 2-1/2"	LT600W24V016-TW
10 mm	Tunable-White 2700K-5000K	100 ft.	600	5.5W (18.2/m)	IP20	Approx. 2-1/2"	LT600D24V100-TW



24V 400 Lumens/Ft. 24-Volt LED Tape Lighting

Tape Width	Kelvin Temperature	Length	Lumens Per Foot	Watts Per Foot	IP Rating	Cutting	Part Number
10 mm	Tunable-White 2700K-5000K	16 ft.	400	3.8W (12.3/m)	IP65	Approx. 2-1/2"	LT400W24V016-TW
10 mm	Tunable-White 2700K-5000K	100 ft.	400	3.8W (12.3/m)	IP20	Approx. 2-1/2"	LT400D24V100-TW



24V 300 Lumens/Ft. 24-Volt LED Tape Lighting

Tape Width	Kelvin Temperature	Length	Lumens Per Foot	Watts Per Foot	IP Rating	Cutting	Part Number
8 mm	Tunable-White 2700K-5000K	16 ft.	300	2.93W (9.2/m)	IP65	Approx. 2-1/4"	L-T600-16-24VMW
8 mm	Tunable-White 2700K-5000K	100 ft.	300	2.93W (9.2/m)	IP20	Approx. 2-1/4"	L-T600-100-24V



12V 300 Lumens/Ft. 24-Volt LED Tape Lighting

Tape Width	Kelvin Temperature	Length	Lumens Per Foot	Watts Per Foot	IP Rating	Cutting	Part Number
8 mm	Tunable-White 2700K-5000K	16 ft.	300	2.93W (9.2/m)	IP65	Approx. 1-1/8"	L-T600-16-MW
8 mm	Tunable-White 2700K-5000K	100 ft.	300	2.93W (9.2/m)	IP20	Approx. 1-1/8"	L-T600-100-12V

NOTE: Tunable-White Lighting can be configured as a static white lighting option of 2700K or 5000K if not using tunable controllers.

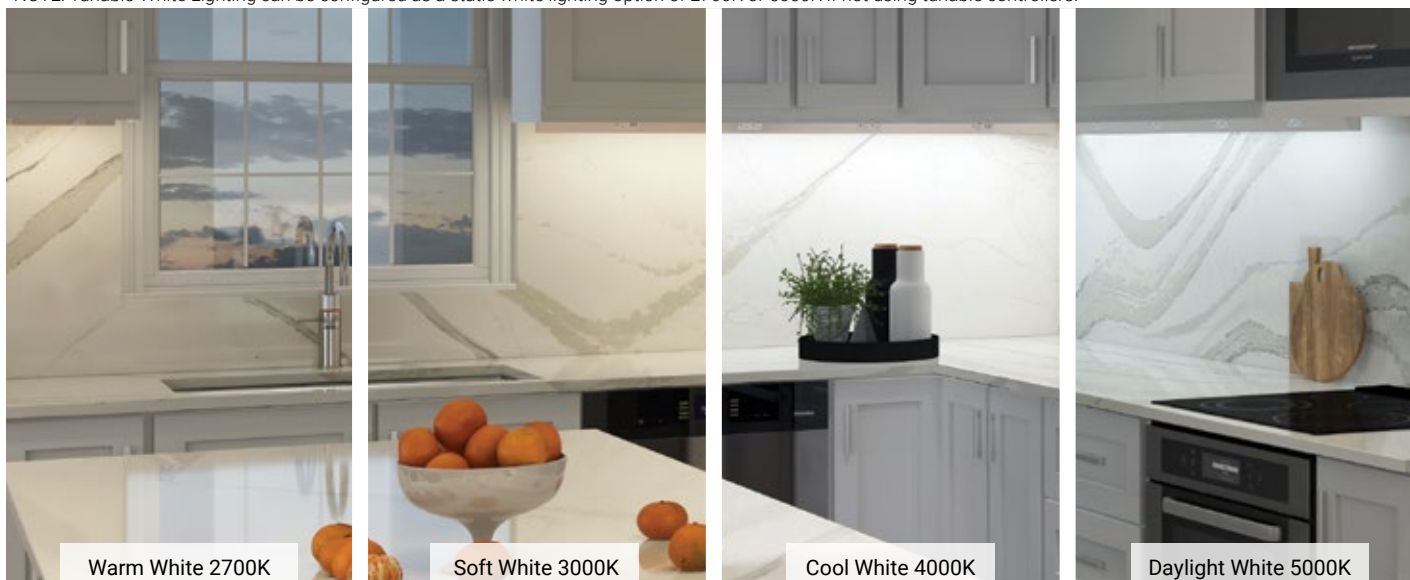

Warm White 2700K

Soft White 3000K

Cool White 4000K

Daylight White 5000K



12V and 24V LED Tape Light

Single-White Lighting

Highlight the beauty of any space with radiant and functional tape lighting that is easy-to-install. Cut the length needed and use the rest elsewhere!

24-Volt, 600 Lumens/Ft.

Field cuttable approximately every 2"



24-Volt, 400 Lumens/Ft.

Field cuttable approximately every 2"



24-Volt, 225 Lumens/Ft.

Field cuttable approximately every 2"



12-Volt, 225 Lumens/Ft.

Field cuttable approximately every 1"



12-Volt, 126 Lumens/Ft. (Side-View)

Field cuttable approximately every 2"



24-Volt, 120 Lumens/Ft.

Field cuttable approximately every 4"



12-Volt, 120 Lumens/Ft.

Field cuttable approximately every 2"



About the Product

- Exceptional color rendering of 90+ CRI (Color Rendering Index)
- Dimmable (with compatible dimmer)
- WAV Smart Control™ compatible for smart home connection
- 12V or 24V power supply required (order separately)
- Aluminum housings with frosted or clear lens available for clean installation (order separately)
- No Ultraviolet (UV) or Infrared (IR)
- 3M™ 300LSE waterproof adhesive tape
- 50,000 hour LED life at 70% lumen maintenance
- UL Listed

Applications

- Under cabinet
- Interior cabinet
- Cove
- Outdoor
- Drawer (Side-view)

Kelvin Temperature Options

- | | |
|--|--|
| | |
| | |

Accessories

Find installation components starting on page 586



Single-White LED Tape Lighting

Ordering Information

Blue indicates dealer choice: Temp indicates Kelvin temperature. L-VMW600-16-30 (Example part number for 225 Lumens/ft., 12V tape light in 3000K Kelvin temperature)



HIGHER

Tape

Width

24V 600 Lumens/Ft. 24-Volt LED Tape Lighting

Kelvin Temperature	Length	Lumens Per Foot	Watts Per Foot	IP Rating	Cutting	Part Number
3000K, 4000K	16 ft.	600	5.5W (18/m)	IP65	Approx. 2"	LS600W24V016-Temp
3000K, 4000K	100 ft.	600	5.5W (18/m)	IP20	Approx. 2"	LS600D24V100-Temp



HIGH

Tape

Width

24V 400 Lumens/Ft. 24-Volt LED Tape Lighting

Kelvin Temperature	Length	Lumens Per Foot	Watts Per Foot	IP Rating	Cutting	Part Number
3000K, 4000K	16 ft.	400	3.5W (11.5/m)	IP65	Approx. 2"	LS400W24V016-Temp
3000K, 4000K	100 ft.	400	3.5W (11.5/m)	IP20	Approx. 2"	LS400D24V100-Temp



STANDARD

Tape

Width

24V 225 Lumens/Ft. 24-Volt LED Tape Lighting

Kelvin Temperature	Length	Lumens Per Foot	Watts Per Foot	IP Rating	Cutting	Part Number
2700K, 3000K, 4000K	16 ft.	225	2.8W (9.2/m)	IP65	Approx. 2"	L-VMW24-16-Temp
3000K, 4000K	100 ft.	225	2.8W (9.2/m)	IP20	Approx. 2"	L-V24-2-100-Temp



STANDARD

Tape

Width

12V 225 Lumens/Ft. 12-Volt LED Tape Lighting

Kelvin Temperature	Length	Lumens Per Foot	Watts Per Foot	IP Rating	Cutting	Part Number
2700K, 3000K, 4000K, 5000K	16 ft.	225	2.8W (9.2/m)	IP65	Approx. 1"	L-VMW600-16-Temp
2700K, 3000K, 4000K, 5000K	32 ft.	225	2.8W (9.2/m)	IP65	Approx. 1"	L-VMW600-32-Temp
2700K, 3000K, 4000K, 5000K	100 ft.	225	2.8W (9.2/m)	IP20	Approx. 1"	L-V600-100-Temp



ACCENT

Tape

Width

12V 126 Lumens/Ft. 12-Volt LED Tape Lighting (Side-View)

Kelvin Temperature	Length	Lumens Per Foot	Watts Per Foot	IP Rating	Cutting	Part Number
3000K, 4000K	16 ft.	126	1.6W (5.2/m)	IP20	Approx. 2"	L-SV300-16-Temp

NOTE: Diodes are placed on the side of this tape lighting to create a directional light spray.



ACCENT

Tape

Width

24V 120 Lumens/Ft. 24-Volt LED Tape Lighting

Kelvin Temperature	Length	Lumens Per Foot	Watts Per Foot	IP Rating	Cutting	Part Number
2700K, 3000K, 4000K	16 ft.	120	1.5W (5/m)	IP65	Approx. 4"	L-RMW24-16-Temp
3000K, 4000K	100 ft.	120	1.5W (5/m)	IP20	Approx. 4"	L-R24-1-100-Temp



ACCENT

Tape

Width

12V 120 Lumens/Ft. 12-Volt LED Tape Lighting

Kelvin Temperature	Length	Lumens Per Foot	Watts Per Foot	IP Rating	Cutting	Part Number
2700K, 3000K, 4000K, 5000K	16 ft.	120	1.5W (5/m)	IP65	Approx. 2"	L-RMW300-16-Temp
2700K, 3000K, 4000K, 5000K	32 ft.	120	1.5W (5/m)	IP65	Approx. 2"	L-RMW300-32-Temp
2700K, 3000K, 4000K, 5000K	100 ft.	120	1.5W (5/m)	IP20	Approx. 2"	L-R300-100-Temp

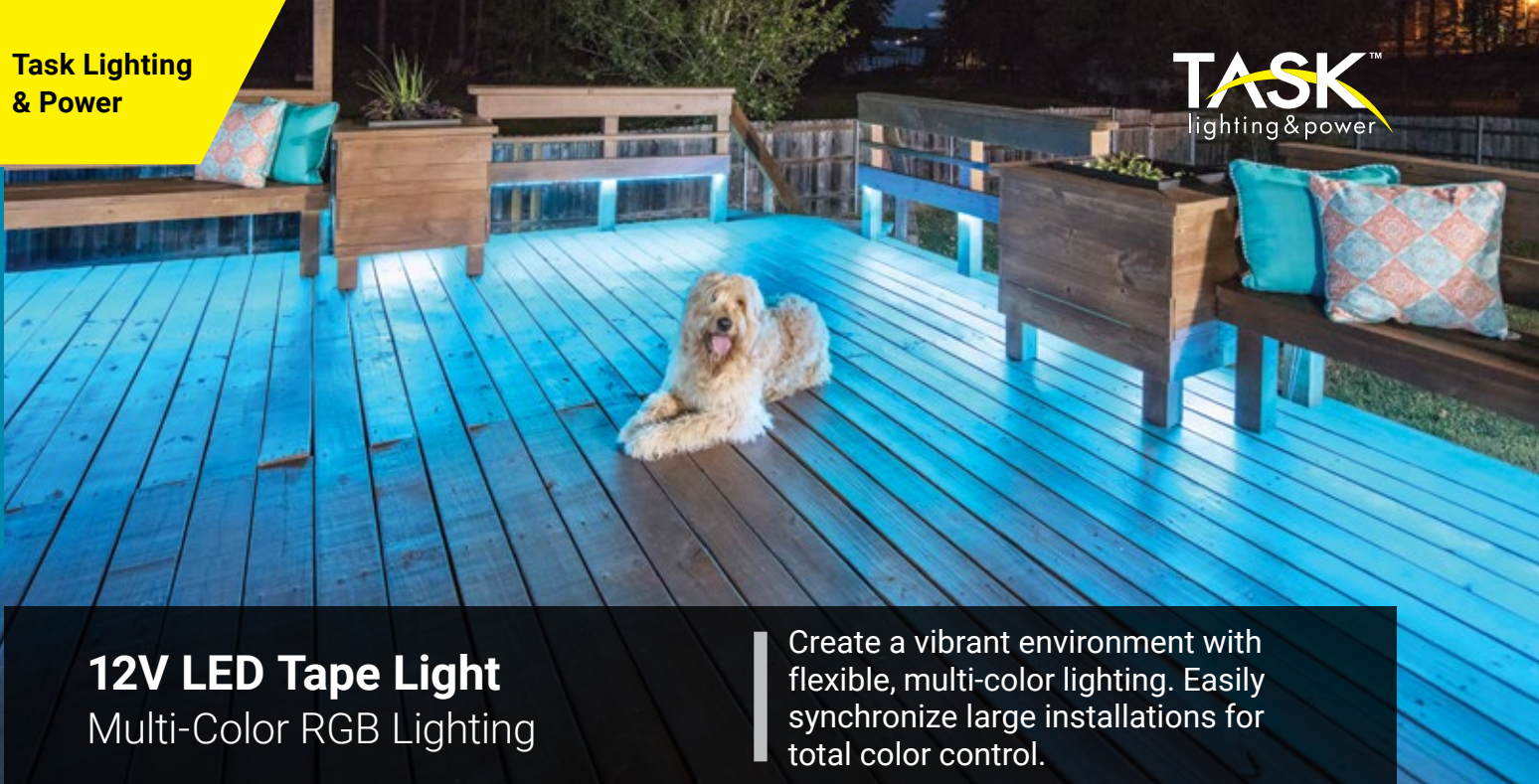

12V LED Tape Light Multi-Color RGB Lighting

Create a vibrant environment with flexible, multi-color lighting. Easily synchronize large installations for total color control.

Field cuttable approximately every 2"



About the Product

- Easy to install thanks to the upgraded connectors!
- Dimmable (with compatible dimmer)
- WAV Smart Control™ compatible for smart home connection
- 12V power supply required (order separately)
- Repeat the signal with an amplifier for easy color synchronization
- Aluminum housings with frosted or clear lens available for clean installation (order separately)
- No Ultraviolet (UV) or Infrared (IR)
- 3M™ 300LSE waterproof adhesive tape
- 50,000 hour LED life at 70% lumen maintenance
- UL Listed

Applications

- Under cabinet
- Interior cabinet
- Cove
- Outdoor

RGB Snap Connectors

Use with LED Lighting

Part Number	Description	Dimensions
L-10MM-RGB-WTT	Clear snap connector used to connect 4-wire RGB to RGB tape light. Sold individually.	7/8" x 5/8" x 5/16" (22 mm x 15 mm x 7 mm)
L-10MM-RGB-TTTC	Clear snap connector used to connect RGB tape light to RGB tape light. Sold individually.	3/4" x 5/8" x 5/16" (19 mm x 15 mm x 7 mm)



L-10MM-RGB-WTT



L-10MM-RGB-TTTC

Accessories

Find installation components starting on page 586



12V 130 Lumens/Ft. 12-Volt LED Tape Lighting

Tape Width	Color Output	Length	Lumens/Ft	Watts/Ft	IP Rating	Cutting	Part Number
10 mm	Multi-Color RGB	16 ft.	130	3.5W (12/m)	IP65	Approx. 2"	L-RGB-M300-16
10 mm	Multi-Color RGB	32 ft.	130	3.5W (12/m)	IP65	Approx. 2"	L-RGBM300-32





Behind a TV

Cabinet Interior

Beneath Shelving

Lighting an entertainment center

Like what you see? It's easy to recreate this professional look in an entertainment center with the products below.

What you need:

Need help calculating how many of each product your project needs? Contact Design Services at 866-848-9094 for recommendations.

LED Tape Lighting
L-RGBM300-32



Snap Connectors and Wire
L-10MM-RGB-WTT and
L-RGB-4C-WIRE



Plug-in Power Supply
T-60W-12V-PI



Wireless Controller, Receiver, and Amplifier T-C-RGBWC-RF-WT,
T-WAV-WR180-RGB, T-AMP-180W



Want to add lighting, but still unsure how or where?

No problem! Contact our friendly in-house **Design Services** at **866-848-9094** or email **DesignAndSupport@TaskLighting.com**. They'll help with technical support, product questions, layout suggestions, and advice on the best products for any project.



LIVE SUPPORT!

LED Linear Fixtures

Fully assembled linear fixtures to easily add to any space

Upgrade any design with a linear fixture to achieve sleek and versatile lighting solutions, ideal for adding functionality to cabinet lighting.



Create this look with 4 basic components:

LED Linear Fixture



Plug-in Power Supply

T-60W-12V-PI



Wireless Controller

T-Q-4Z-WC-RF and T-Q-WR96



Wire

T-CW20G-STR-25



LED Linear Fixtures made easy

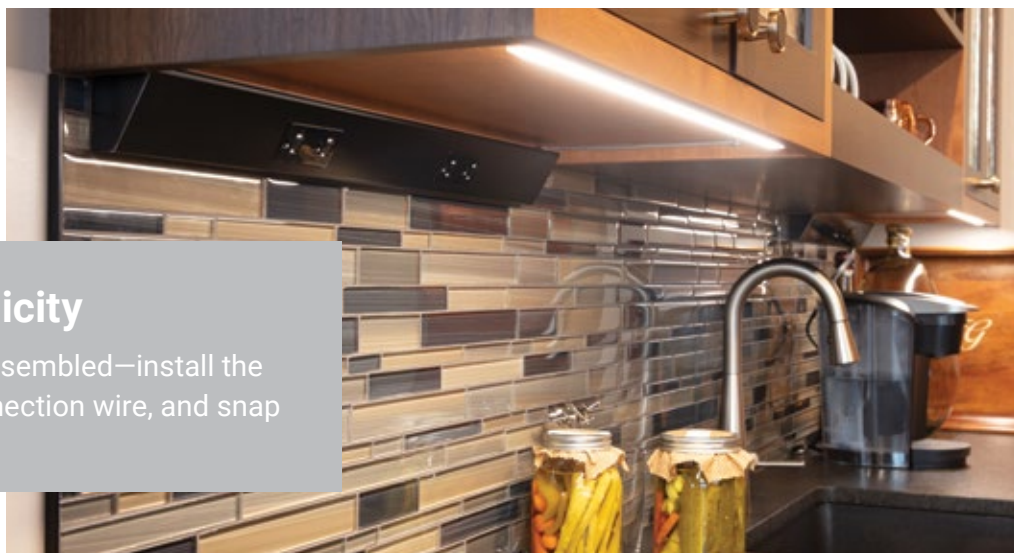

Designed for simplicity

Every fixture comes fully assembled—install the mounting clips, attach connection wire, and snap into place.



Designed for cabinetry

Assembled in Kearney, Nebraska with standard sizes that fit modular cabinetry or choose from the abundant custom options available.

Boundless applications

Surface mount, angled, or recessed profile options paired with choices of output and Kelvin temperature allow for confidence in every situation. Control with wireless, wired, or smart home systems.



U.S. PATENT
10,721,801

24V Premium Flat LED Linear Fixtures Tunable-White Lighting

This high-output, visually appealing fixture fits right into a mounting bracket, and has matching wireway for a clean, finished look. Adjust Kelvin temperature at any time.

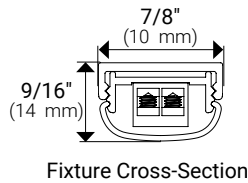

Applications

- Under cabinet
- Shelves
- Laundry rooms
- Outdoor

Tunable-White Kelvin Temperatures

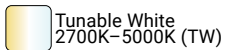

Lumen Output Options



Accessories

Find installation components starting on page 586

About the Product

- Tunable-White lighting from Warm White to Daylight White and all shades of white in between
- Tune the white light and adjust the brightness separately with required wired, wireless controller, (order separately) or smart home device (not included)
- Use for a variety of surface mount applications made easy with a premium mounting bracket to snap the fixture into place
- Install with the Plastic WireWay to neatly conceal wires for a sleek finished look
- Easy to install using the two-wire connectors on either end of the fixture
- 24V power supply required (order separately)
- Dimmable (with compatible dimmer)
- No Ultraviolet (UV) or Infrared (IR)
- Compatible with WAV Smart Control™ devices
- 50,000 hour LED life at 70% lumen maintenance
- UL Listed



LED Lighting
5 YEAR
WARRANTY

ASSEMBLED
IN THE
USA

WAV
Smart Home
Compatible

UL
LISTED

24V Premium Flat LED Linear Fixtures

Tunable-White Lighting Ordering Information

Blue indicates dealer choice: Color indicates mounting color. LT6PP24V09B03W (Example part number for 9" fixture with black mount)



24V

600 Lumens/Ft.

Cabinet Width	Fixture Length	Total Watts	Total Lumens	Part Number
9"	5-11/16"(145 mm)	3	205	LT6PF24V09-Color03W
12"	8-1/8"(206 mm)	4	293	LT6PF24V12-Color04W
15"	10-5/8"(270 mm)	6	468	LT6PF24V15-Color06W
18"	15-1/2"(394 mm)	7	555	LT6PF24V18-Color07W
21"	18"(457 mm)	9	728	LT6PF24V21-Color09W
24"	20-7/16"(519 mm)	10	815	LT6PF24V24-Color10W
27"	22-7/8"(581 mm)	11	903	LT6PF24V27-Color11W
30"	25-3/8"(645 mm)	13	1078	LT6PF24V30-Color13W
33"	30-1/4"(768 mm)	14	1165	LT6PF24V33-Color14W
36"	32-3/4"(832 mm)	15	1253	LT6PF24V36-Color15W
39"	35-3/16"(894 mm)	17	1428	LT6PF24V39-Color17W
42"	37-5/8"(956 mm)	18	1515	LT6PF24V42-Color18W
45"	42-9/16"(1081 mm)	19	1603	LT6PF24V45-Color19W
48"	45"(1143 mm)	21	1778	LT6PF24V48-Color21W

Aluminum Profiles

Use with LED Tape Lighting

Part Number	Description	Dimensions
L-PFAP-FR-Color-48	48" field-cutttable premium flat aluminum profile, frosted lens, plastic colored mount. Available in Black (BK) or White (WT). Compatible with 8 mm and 10 mm LED tape lighting. Use with L-PFEC for end caps.	48" x 7/8" x 9/16" (1219 mm x 23 mm x 14 mm)
L-PFAP-FR-Color-90	90" field-cutttable premium flat aluminum profile, frosted lens, plastic colored mount. Available in Black (BK) or White (WT). Compatible with 8 mm and 10 mm LED tape lighting. Use with L-PFEC for end caps.	90" x 7/8" x 9/16" (2286 mm x 23 mm x 14 mm)



L-PFAP

Plastic Wire Managers

Use for hiding wires leading to LED Lighting

Part Number	Description	Dimensions
L-PFWW-Color-48	48" Plastic WireWay used to neatly conceal wire. Available in Black (BK) or White (WT).	48" x 7/8" x 9/16" (1219 mm x 23 mm x 14 mm)
L-PFWW-Color-90	90" Plastic WireWay used to neatly conceal wire. Available in Black (BK) or White (WT).	90" x 7/8" x 9/16" (2286 mm x 23 mm x 14 mm)
L-PFMJ-Color-12	(2) 12" WireWay pieces with 45° miter joint for Premium Linear Fixture. Available in Black (BK) or White (WT).	12" x 7/8" x 9/16" (305 mm x 23 mm x 14 mm)



L-PFWW-BK-48



L-PFMJ-BK-12

End Caps

Use with aluminum profiles

Part Number	Description	Dimensions
L-PFEC-Color	End caps for L-PFAP aluminum housing with wire entry openings. Available in Black (BK) or White (WT). Sold individually.	5/16" x 7/8" x 9/16" (8 mm x 23 mm x 14 mm)



L-PFEC



24V Premium Flat LED Linear Fixtures Single-White Lighting

This high-output, visually appealing fixture fits right into a mounting bracket, and has matching wireway for a clean, finished look.

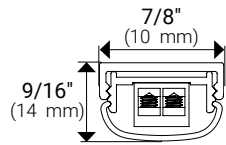

Fixture Cross-Section

Applications

- Under cabinet
- Shelves
- Laundry rooms
- Outdoor

Kelvin Temperature Options



Lumen Output Options



HIGHER

Accessories

Find installation components starting on page 586

About the Product

- Use for a variety of surface mount applications made easy with a premium mounting bracket to snap the fixture into place
- Install with the Plastic WireWay to neatly conceal wires for a sleek finished look
- Easy to install using the two-wire connectors on either end of the fixture
- Plug-in or hardwired power supply required (order separately)
- Dimmable (with compatible dimmer)
- No Ultraviolet (UV) or Infrared (IR)
- Compatible with WAV Smart Control™ devices
- 50,000 hour LED life at 70% lumen maintenance
- UL Listed



24V Premium Flat LED Linear Fixtures

Single-White Lighting Ordering Information

Blue indicates dealer choice; Color indicates mounting color. Temp indicates Kelvin temperature.
LS6PP24V09B03W3 (Example part number for 9" fixture with black mount in 3000K Kelvin temperature)



24V 600 Lumens/Ft.

Cabinet Width	Fixture Length	Total Watts	Total Lumens	Part Number
9"	6-5/8"(168 mm)	3	265	LS6PF24V09Color03WTemp
12"	8-5/8"(219 mm)	4	345	LS6PF24V12Color04WTemp
15"	12-9/16"(319 mm)	6	503	LS6PF24V15Color06WTemp
18"	14-1/2"(368 mm)	7	580	LS6PF24V18Color07WTemp
21"	18-7/16"(468 mm)	9	738	LS6PF24V21Color09WTemp
24"	20-7/16"(519 mm)	10	818	LS6PF24V24Color10WTemp
27"	24-3/8"(619 mm)	11	975	LS6PF24V27Color11WTemp
30"	26-15/16"(684 mm)	13	1053	LS6PF24V30Color13WTemp
33"	30-1/4"(768 mm)	14	1210	LS6PF24V33Color14WTemp
36"	32-1/4"(819 mm)	15	1290	LS6PF24V36Color15WTemp
39"	36-3/16"(919 mm)	17	1448	LS6PF24V39Color17WTemp
42"	38-1/8"(968 mm)	18	1525	LS6PF24V42Color18WTemp
45"	42-1/16"(1018 mm)	19	1638	LS6PF24V45Color19WTemp
48"	44-1/16"(1119 mm)	21	1763	LS6PF24V48Color21WTemp

Aluminum Profiles

Use with LED Tape Lighting

Part Number	Description	Dimensions
L-PFAP-FR-Color-48	48" field-cutttable premium flat aluminum profile, frosted lens, plastic colored mount. Available in Black (BK) or White (WT). Compatible with 8 mm and 10 mm LED tape lighting. Use with L-PFEC for end caps.	48" x 7/8" x 9/16" (1219 mm x 23 mm x 14 mm)
L-PFAP-FR-Color-90	90" field-cutttable premium flat aluminum profile, frosted lens, plastic colored mount. Available in Black (BK) or White (WT). Compatible with 8 mm and 10 mm LED tape lighting. Use with L-PFEC for end caps.	90" x 7/8" x 9/16" (2286 mm x 23 mm x 14 mm)



L-PFAP

Plastic Wire Managers

Use for hiding wires leading to LED Lighting

Part Number	Description	Dimensions
L-PFWW-Color-48	48" Plastic WireWay used to neatly conceal wire. Available in Black (BK) or White (WT).	48" x 7/8" x 9/16" (1219 mm x 23 mm x 14 mm)
L-PFWW-Color-90	90" Plastic WireWay used to neatly conceal wire. Available in Black (BK) or White (WT).	90" x 7/8" x 9/16" (2286 mm x 23 mm x 14 mm)
L-PFMJ-Color-12	(2) 12" WireWay pieces with 45° miter joint for Premium Linear Fixture. Available in Black (BK) or White (WT).	12" x 7/8" x 9/16" (305 mm x 23 mm x 14 mm)



L-PFWW-BK-48



L-PFMJ-BK-12

End Caps

Use with aluminum profiles

Part Number	Description	Dimensions
L-PFEC-Color	End caps for L-PFAP aluminum housing with wire entry openings. Available in Black (BK) or White (WT). Sold individually.	5/16" x 7/8" x 9/16" (8 mm x 23 mm x 14 mm)



L-PFEC



24V Dual-Mount LED Linear Fixtures Tunable-White Lighting

This multi-purpose fixture can be surface- or recess-mounted, and comes fully assembled. Adjust Kelvin temperature at any time.

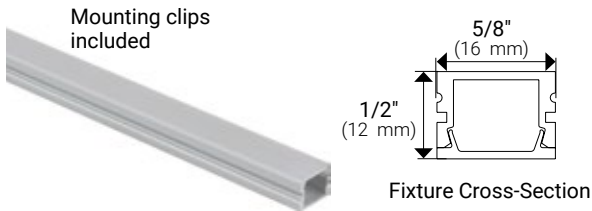

Applications

- Under cabinet
- Interior cabinet
- Shelves
- Built-in cabinets
- Laundry rooms
- Outdoor

Tunable-White Kelvin Temperatures

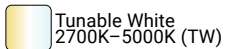

Lumen Output Options



Accessories

Find installation components starting on page 586

About the Product

- Tunable-White lighting from Warm White to Daylight White and all shades of white in between
- Tune the white light and adjust the brightness separately with required wired, wireless controller, (order separately) or smart home device (not included)
- Use for a variety of surface mount applications made easy with included mounting clips
- Alternatively, use for a clean, flangeless flush-mount installation under cabinets or shelves
- Easy to install using the two-wire connectors on either end of the fixture
- 5/8" router recommended for recessed fixture
- 24V power supply required (order separately)
- Dimmable (with compatible dimmer)
- No Ultraviolet (UV) or Infrared (IR)
- Compatible with WAV Smart Control™ devices
- 50,000 hour LED life at 70% lumen maintenance
- UL Listed



24V Dual-Mount LED Linear Fixtures

Tunable-White Lighting Ordering Information



24V

600 Lumens/Ft.

Cabinet Width	Fixture Length	Total Watts	Total Lumens	Part Number
9"	7" (178 mm)	3	184	LT6PD24V09-03W
12"	9-7/16" (240 mm)	4	276	LT6PD24V12-04W
15"	11-15/16" (303 mm)	5	368	LT6PD24V15-05W
18"	14-3/8" (365 mm)	6	460	LT6PD24V18-06W
21"	16-13/16" (427 mm)	7	552	LT6PD24V21-07W
24"	21-3/4" (552 mm)	9	736	LT6PD24V24-09W
27"	24-1/4" (616 mm)	10	828	LT6PD24V27-10W
30"	26-11/16" (678 mm)	11	920	LT6PD24V30-11W
33"	29-1/8" (740 mm)	12	1012	LT6PD24V33-12W
36"	34-1/16" (865 mm)	14	1196	LT6PD24V36-14W
39"	36-1/2" (927 mm)	15	1288	LT6PD24V39-15W
42"	39" (990 mm)	17	1380	LT6PD24V42-17W
45"	41-7/16" (1053 mm)	18	1472	LT6PD24V45-18W
48"	43-15/16" (1116 mm)	19	1564	LT6PD24V48-19W



24V

400 Lumens/Ft.

Cabinet Width	Fixture Length	Total Watts	Total Lumens	Part Number
9"	7" (178 mm)	2	120	LT4PD24V09-02W
12"	9-7/16" (240 mm)	3	180	LT4PD24V12-03W
15"	11-15/16" (303 mm)	3	240	LT4PD24V15-03W
18"	14-3/8" (365 mm)	4	300	LT4PD24V18-04W
21"	16-13/16" (427 mm)	5	360	LT4PD24V21-05W
24"	21-3/4" (552 mm)	6	480	LT4PD24V24-06W
27"	24-1/4" (616 mm)	7	540	LT4PD24V27-07W
30"	26-11/16" (678 mm)	8	600	LT4PD24V30-08W
33"	29-1/8" (740 mm)	8	660	LT4PD24V33-08W
36"	34-1/16" (865 mm)	10	780	LT4PD24V36-10W
39"	36-1/2" (927 mm)	11	840	LT4PD24V39-11W
42"	39" (990 mm)	11	900	LT4PD24V42-11W
45"	41-7/16" (1053 mm)	12	960	LT4PD24V45-12W
48"	43-15/16" (1116 mm)	13	1020	LT4PD24V48-13W



24V

300 Lumens/Ft.

Cabinet Width	Fixture Length	Total Watts	Total Lumens	Part Number
9"	6-7/16" (164 mm)	2	80	LT3PD24V09-02W
12"	8-9/16" (217 mm)	2	120	LT3PD24V12-02W
15"	10-3/4" (273 mm)	3	160	LT3PD24V15-03W
18"	15-1/16" (383 mm)	4	240	LT3PD24V18-04W
21"	17-1/4" (438 mm)	4	280	LT3PD24V21-04W
24"	21-9/16" (548 mm)	6	360	LT3PD24V24-06W
27"	23-3/4" (603 mm)	6	400	LT3PD24V27-06W
30"	25-7/8" (657 mm)	7	440	LT3PD24V30-07W
33"	30-1/4" (768 mm)	8	520	LT3PD24V33-08W
36"	32-3/8" (822 mm)	8	560	LT3PD24V36-08W
39"	36-3/4" (933 mm)	9	640	LT3PD24V39-09W
42"	38-7/8" (987 mm)	10	680	LT3PD24V42-10W
45"	43-1/4" (1099 mm)	11	760	LT3PD24V45-11W
48"	45-3/8" (1153 mm)	12	800	LT3PD24V48-12W

24V Dual-Mount LED Linear Fixtures Single-White Lighting

This multi-purpose fixture can be surface- or recess-mounted and comes fully assembled.

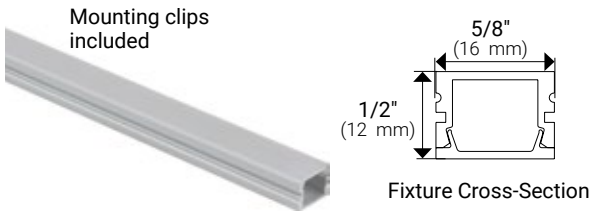
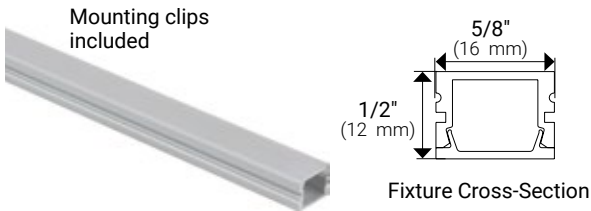

Applications

- Under cabinet
- Interior cabinet
- Shelves
- Built-in cabinets
- Laundry rooms
- Outdoor

Kelvin Temperature Options



Lumen Output Options



Accessories

Find installation components starting on page 586

About the Product

- Use for a variety of surface mount applications made easy with included mounting clips
- Alternatively, use for a clean, flangeless flush-mount installation under cabinets or shelves
- Easy to install using the two-wire connectors on either end of the fixture
- 5/8" router recommended for recessed fixture
- 24V power supply required (order separately)
- Dimmable (with compatible dimmer)
- No Ultraviolet (UV) or Infrared (IR)
- Compatible with WAV Smart Control™ devices
- 50,000 hour LED life at 70% lumen maintenance
- UL Listed



24V Dual-Mount LED Linear Fixtures

Single-White Lighting Ordering Information

Blue indicates dealer choice: Temp indicates Kelvin temperature. LS4PD24V09-02W3 (Example part number for 400 lumens/ft 9" fixture in 3000K Kelvin temperature)



24V 600 Lumens/Ft.

HIGHER Cabinet Width	Fixture Length	Total Watts	Total Lumens	Part Number
9"	6"(152 mm)	2	148	LS6PD24V09-02WTemp
12"	8"(203 mm)	3	222	LS6PD24V12-03WTemp
15"	11-15/16"(303 mm)	5	370	LS6PD24V15-05WTemp
18"	15-7/8"(403 mm)	7	518	LS6PD24V18-07WTemp
21"	17-13/16"(452 mm)	8	592	LS6PD24V21-08WTemp
24"	21-3/4"(552 mm)	9	740	LS6PD24V24-09WTemp
27"	23-3/4"(603 mm)	10	814	LS6PD24V27-10WTemp
30"	27-11/16"(703 mm)	12	962	LS6PD24V30-12WTemp
33"	29-5/8"(752 mm)	13	1036	LS6PD24V33-13WTemp
36"	33-9/16"(852 mm)	15	1184	LS6PD24V36-15WTemp
39"	35-9/16"(903 mm)	15	1258	LS6PD24V39-15WTemp
42"	39-1/2"(1003 mm)	17	1406	LS6PD24V42-17WTemp
45"	41-7/16"(1053 mm)	18	1480	LS6PD24V45-18WTemp
48"	45-3/8"(1153 mm)	20	1628	LS6PD24V48-20WTemp



24V 400 Lumens/Ft.

HIGH Cabinet Width	Fixture Length	Total Watts	Total Lumens	Part Number
9"	6"(152 mm)	2	100	LS4PD24V09-02WTemp
12"	8"(203 mm)	2	150	LS4PD24V12-02WTemp
15"	11-15/16"(303 mm)	3	250	LS4PD24V15-03WTemp
18"	15-7/8"(403 mm)	5	350	LS4PD24V18-05WTemp
21"	17-13/16"(452 mm)	5	400	LS4PD24V21-05WTemp
24"	21-3/4"(552 mm)	6	500	LS4PD24V24-06WTemp
27"	23-3/4"(603 mm)	7	550	LS4PD24V27-07WTemp
30"	27-11/16"(703 mm)	8	650	LS4PD24V30-08WTemp
33"	29-5/8"(752 mm)	9	700	LS4PD24V33-09WTemp
36"	33-9/16"(852 mm)	10	800	LS4PD24V36-10WTemp
39"	35-9/16"(903 mm)	10	850	LS4PD24V39-10WTemp
42"	39-1/2"(1003 mm)	12	950	LS4PD24V42-12WTemp
45"	41-7/16"(1053 mm)	12	1000	LS4PD24V45-12WTemp
48"	45-3/8"(1153 mm)	13	1100	LS4PD24V48-13WTemp



24V 225 Lumens/Ft.

STANDARD Cabinet Width	Fixture Length	Total Watts	Total Lumens	Part Number
9"	6"(152 mm)	1	56	LS2PD24V09-01WTemp
12"	8"(203 mm)	2	84	LS2PD24V12-02WTemp
15"	11-15/16"(303 mm)	3	140	LS2PD24V15-03WTemp
18"	15-7/8"(403 mm)	4	196	LS2PD24V18-04WTemp
21"	17-13/16"(452 mm)	4	224	LS2PD24V21-04WTemp
24"	21-3/4"(552 mm)	5	280	LS2PD24V24-05WTemp
27"	23-3/4"(603 mm)	5	308	LS2PD24V27-05WTemp
30"	27-11/16"(703 mm)	6	364	LS2PD24V30-06WTemp
33"	29-5/8"(752 mm)	7	392	LS2PD24V33-07WTemp
36"	33-9/16"(852 mm)	8	448	LS2PD24V36-08WTemp
39"	35-9/16"(903 mm)	8	476	LS2PD24V39-08WTemp
42"	39-1/2"(1003 mm)	9	532	LS2PD24V42-09WTemp
45"	41-7/16"(1053 mm)	9	560	LS2PD24V45-09WTemp
48"	45-3/8"(1153 mm)	10	616	LS2PD24V48-10WTemp



24V 120 Lumens/Ft.

ACCENT Cabinet Width	Fixture Length	Total Watts	Total Lumens	Part Number
9"	6"(152 mm)	1	30	LS1PD24V09-01WTemp
12"	9-15/16"(252 mm)	1	60	LS1PD24V12-01WTemp
15"	9-15/16"(252 mm)	1	60	LS1PD24V15-01WTemp
18"	13-7/8"(352 mm)	2	90	LS1PD24V18-02WTemp
21"	17-13/16"(452 mm)	2	120	LS1PD24V21-02WTemp
24"	21-3/4"(552 mm)	3	150	LS1PD24V24-03WTemp
27"	21-3/4"(552 mm)	3	150	LS1PD24V27-03WTemp
30"	25-11/16"(652 mm)	3	180	LS1PD24V30-03WTemp
33"	29-5/8"(752 mm)	4	210	LS1PD24V33-04WTemp
36"	33-9/16"(853 mm)	4	240	LS1PD24V36-04WTemp
39"	33-9/16"(853 mm)	4	240	LS1PD24V39-04WTemp
42"	37-1/2"(953 mm)	5	270	LS1PD24V42-05WTemp
45"	41-7/16"(1053 mm)	5	300	LS1PD24V45-05WTemp
48"	45-3/8"(1152 mm)	6	330	LS1PD24V48-06WTemp



Angled LED Linear Fixtures Tunable-White Lighting

Select a different shade of white for any occasion after lighting is installed. Easy-to-install, fully assembled fixtures.

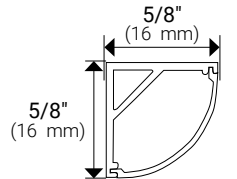

Fixture Cross-Section

Applications

- Interior cabinet
- Stairs
- Closet

Tunable-White Kelvin Temperatures



Lumen Output Options



Accessories

Find installation components starting on page 586

About the Product

- Tunable-White lighting from Warm White to Daylight White and all shades of white in between
- Tune the white light and adjust the brightness separately with required wired, wireless controller, (order separately) or smart home device (not included)
- Use when directional lighting in cabinets or other areas is desired
- Easy to install using the two-wire connectors on either end of the fixture
- Install included mounting clips for quick and easy installation
- 12V or 24V power supply required (order separately)
- Dimmable (with compatible dimmer)
- No Ultraviolet (UV) or Infrared (IR)
- Compatible with WAV Smart Control™ devices
- 50,000 hour LED life at 70% lumen maintenance
- UL Listed



12V and 24V Angled LED Linear Fixtures

Tunable-White Lighting Ordering Information



24V 600 Lumens/Ft.

Cabinet Width	Total Fixture Length	Total Watts	Total Lumens	Part Number
9"	5-11/16"(145 mm)	3	205	LT6P324V09-03W
12"	8-1/8"(206 mm)	4	293	LT6P324V12-04W
15"	10-5/8"(270 mm)	6	468	LT6P324V15-06W
18"	15-1/2"(394 mm)	7	555	LT6P324V18-07W
21"	18"(457 mm)	9	728	LT6P324V21-09W
24"	20-7/16"(519 mm)	10	815	LT6P324V24-10W
27"	22-7/8"(581 mm)	11	903	LT6P324V27-11W
30"	25-3/8"(645 mm)	13	1078	LT6P324V30-13W
33"	30-1/4"(768 mm)	14	1165	LT6P324V33-14W
36"	32-3/4"(832 mm)	15	1253	LT6P324V36-15W
39"	35-3/16"(894 mm)	17	1428	LT6P324V39-17W
42"	37-5/8"(956 mm)	18	1515	LT6P324V42-18W
45"	42-9/16"(1081 mm)	19	1603	LT6P324V45-19W
48"	45"(1143 mm)	21	1778	LT6P324V48-21W



24V 400 Lumens/Ft.

Cabinet Width	Total Fixture Length	Total Watts	Total Lumens	Part Number
9"	5-11/16"(145 mm)	3	137	LT4P324V09-03W
12"	8-1/8"(206 mm)	3	195	LT4P324V12-03W
15"	10-5/8"(270 mm)	4	312	LT4P324V15-04W
18"	15-1/2"(394 mm)	5	370	LT4P324V18-05W
21"	18"(457 mm)	6	485	LT4P324V21-06W
24"	20-7/16"(519 mm)	7	543	LT4P324V24-07W
27"	22-7/8"(581 mm)	8	602	LT4P324V27-08W
30"	25-3/8"(645 mm)	9	718	LT4P324V30-09W
33"	30-1/4"(768 mm)	10	777	LT4P324V33-10W
36"	32-3/4"(832 mm)	10	835	LT4P324V36-10W
39"	35-3/16"(894 mm)	12	952	LT4P324V39-12W
42"	37-5/8"(956 mm)	12	1010	LT4P324V42-12W
45"	42-9/16"(1081 mm)	13	1068	LT4P324V45-13W
48"	45"(1143 mm)	14	1185	LT4P324V48-14W



24V 300 Lumens/Ft.

Cabinet Width	Total Fixture Length	Total Watts	Total Lumens	Part Number
9"	5-1/8"(130 mm)	3	99	LT2P324V09-03W
12"	7-5/16"(186 mm)	3	141	LT2P324V12-03W
15"	11-11/16"(297 mm)	4	226	LT2P324V15-04W
18"	13-7/8"(352 mm)	5	268	LT2P324V18-05W
21"	18-3/16"(462 mm)	6	352	LT2P324V21-06W
24"	20-3/8"(518 mm)	6	394	LT2P324V24-06W
27"	22-9/16"(573 mm)	7	436	LT2P324V27-07W
30"	26-15/16"(684 mm)	8	521	LT2P324V30-08W
33"	29-1/8"(740 mm)	9	563	LT2P324V33-09W
36"	31-5/16"(795 mm)	9	605	LT2P324V36-09W
39"	35-11/16"(906 mm)	10	690	LT2P324V39-10W
42"	37-7/8"(962 mm)	11	732	LT2P324V42-11W
45"	40-1/16"(1018 mm)	11	775	LT2P324V45-11W
48"	44-7/16"(1129 mm)	12	859	LT2P324V48-12W



12V 300 Lumens/Ft.

Cabinet Width	Total Fixture Length	Total Watts	Total Lumens	Part Number
9"	5-1/8"(130 mm)	3	99	LT2P312V09-03W
12"	7-5/16"(186 mm)	3	141	LT2P312V12-03W
15"	11-11/16"(297 mm)	4	226	LT2P312V15-04W
18"	13-7/8"(352 mm)	5	268	LT2P312V18-05W
21"	18-3/16"(462 mm)	6	352	LT2P312V21-06W
24"	20-3/8"(518 mm)	6	394	LT2P312V24-06W
27"	22-9/16"(573 mm)	7	436	LT2P312V27-07W
30"	26-15/16"(684 mm)	8	521	LT2P312V30-08W
33"	29-1/8"(740 mm)	9	563	LT2P312V33-09W
36"	31-5/16"(795 mm)	9	605	LT2P312V36-09W
39"	35-11/16"(906 mm)	10	690	LT2P312V39-10W
42"	37-7/8"(962 mm)	11	732	LT2P312V42-11W
45"	40-1/16"(1018 mm)	11	775	LT2P312V45-11W
48"	44-7/16"(1129 mm)	12	859	LT2P312V48-12W

Angled LED Linear Fixtures Single-White Lighting

Energize any space with versatile, simple white lighting. Easy-to-install, fully assembled fixtures.



Mounting clips included

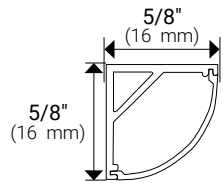

Fixture Cross-Section

Applications

- Interior cabinet
- Stairs
- Closet

Kelvin Temperature Options



Lumen Output Options



Accessories

Find installation components starting on page 586

About the Product

- Use when directional lighting in cabinets or other areas is desired
- Easy to install using the two-wire connectors on either end of the fixture
- Install included mounting clips for quick and easy installation
- 12V or 24V power supply required (order separately)
- Dimmable (with compatible dimmer)
- No Ultraviolet (UV) or Infrared (IR)
- Compatible with WAV Smart Control™ devices
- 50,000 hour LED life at 70% lumen maintenance
- UL Listed



12 and 24V Angled LED Linear Fixtures

Single-White Lighting Ordering Information

Blue indicates dealer choice: Temp indicates Kelvin temperature. LS4P324V09-03W3 (Example part number for 400 lumens/ft 9" fixture in 3000K Kelvin temperature)



HIGHER Cabinet

24V 600 Lumens/Ft.

Cabinet Width	Fixture Length	Total Watts	Total Lumens	Part Number
9"	6-5/8"(168 mm)	3	265	LS6P324V09-03WTemp
12"	8-5/8"(219 mm)	4	345	LS6P324V12-04WTemp
15"	12-9/16"(319 mm)	6	503	LS6P324V15-06WTemp
18"	14-1/2"(368 mm)	7	580	LS6P324V18-07WTemp
21"	18-7/16"(468 mm)	9	738	LS6P324V21-09WTemp
24"	20-7/16"(519 mm)	10	818	LS6P324V24-10WTemp
27"	24-3/8"(619 mm)	12	975	LS6P324V27-12WTemp
30"	26-15/16"(684 mm)	12	1053	LS6P324V30-12WTemp
33"	30-1/4"(768 mm)	14	1210	LS6P324V33-14WTemp
36"	32-1/4"(819 mm)	15	1290	LS6P324V36-15WTemp
39"	36-3/16"(919 mm)	17	1448	LS6P324V39-17WTemp
42"	38-1/8"(968 mm)	18	1525	LS6P324V42-18WTemp
45"	42-1/16"(1018 mm)	20	1683	LS6P324V45-20WTemp
48"	44-1/16"(1119 mm)	21	1763	LS6P324V48-21WTemp



HIGH Cabinet

24V 400 Lumens/Ft.

Cabinet Width	Fixture Length	Total Watts	Total Lumens	Part Number
9"	6-5/8"(168 mm)	3	137	LS4P324V09-03WTemp
12"	8-5/8"(219 mm)	3	195	LS4P324V12-03WTemp
15"	12-9/16"(319 mm)	4	312	LS4P324V15-04WTemp
18"	14-1/2"(368 mm)	5	370	LS4P324V18-05WTemp
21"	18-7/16"(468 mm)	6	485	LS4P324V21-06WTemp
24"	20-7/16"(519 mm)	7	543	LS4P324V24-07WTemp
27"	24-3/8"(619 mm)	8	602	LS4P324V27-08WTemp
30"	26-15/16"(684 mm)	8	718	LS4P324V30-08WTemp
33"	30-1/4"(768 mm)	10	777	LS4P324V33-10WTemp
36"	32-1/4"(819 mm)	10	835	LS4P324V36-10WTemp
39"	36-3/16"(919 mm)	11	952	LS4P324V39-11WTemp
42"	38-1/8"(968 mm)	12	1010	LS4P324V42-12WTemp
45"	42-1/16"(1018 mm)	13	1068	LS4P324V45-13WTemp
48"	44-1/16"(1119 mm)	14	1185	LS4P324V48-14WTemp



STANDARD Cabinet

24V 225 Lumens/Ft.

Cabinet Width	Fixture Length	Total Watts	Total Lumens	Part Number
9"	6-5/8"(168 mm)	3	99	LV2P324V09-03WTemp
12"	8-5/8"(219 mm)	3	129	LV2P324V12-03WTemp
15"	12-9/16"(319 mm)	4	188	LV2P324V15-04WTemp
18"	14-1/2"(368 mm)	5	218	LV2P324V18-05WTemp
21"	18-7/16"(468 mm)	5	277	LV2P324V21-05WTemp
24"	20-7/16"(519 mm)	6	307	LV2P324V24-06WTemp
27"	24-3/8"(619 mm)	7	366	LV2P324V27-07WTemp
30"	26-15/16"(684 mm)	7	395	LV2P324V30-07WTemp
33"	30-1/4"(768 mm)	8	454	LV2P324V33-08WTemp
36"	32-1/4"(819 mm)	9	484	LV2P324V36-09WTemp
39"	36-3/16"(919 mm)	10	543	LV2P324V39-10WTemp
42"	38-1/8"(968 mm)	10	572	LV2P324V42-10WTemp
45"	42-1/16"(1018 mm)	11	631	LV2P324V45-11WTemp
48"	44-1/16"(1119 mm)	12	661	LV2P324V48-12WTemp



STANDARD Cabinet

12V 225 Lumens/Ft.

Cabinet Width	Fixture Length	Total Watts	Total Lumens	Part Number
9"	6-5/8"(168 mm)	3	99	LV2P312V09-03WTemp
12"	8-5/8"(219 mm)	3	129	LV2P312V12-03WTemp
15"	12-9/16"(319 mm)	4	188	LV2P312V15-04WTemp
18"	14-1/2"(368 mm)	5	218	LV2P312V18-05WTemp
21"	18-7/16"(468 mm)	5	277	LV2P312V21-05WTemp
24"	20-7/16"(519 mm)	6	307	LV2P312V24-06WTemp
27"	24-3/8"(619 mm)	7	366	LV2P312V27-07WTemp
30"	26-15/16"(684 mm)	7	395	LV2P312V30-07WTemp
33"	30-1/4"(768 mm)	8	454	LV2P312V33-08WTemp
36"	32-1/4"(819 mm)	9	484	LV2P312V36-09WTemp
39"	36-3/16"(919 mm)	10	543	LV2P312V39-10WTemp
42"	38-1/8"(968 mm)	10	572	LV2P312V42-10WTemp
45"	42-1/16"(1018 mm)	11	631	LV2P312V45-11WTemp
48"	44-1/16"(1119 mm)	12	661	LV2P312V48-12WTemp



ACCENT Cabinet

24V 120 Lumens/Ft.

Cabinet Width	Fixture Length	Total Watts	Total Lumens	Part Number
9"	4-11/16"(119 mm)	2	53	LR1P324V09-02WTemp
12"	8-5/8"(219 mm)	2	69	LR1P324V12-02WTemp
15"	12-9/16"(319 mm)	2	101	LR1P324V15-02WTemp
18"	12-9/16"(319 mm)	3	116	LR1P324V18-03WTemp
21"	16-1/2"(419 mm)	3	148	LR1P324V21-03WTemp
24"	20-7/16"(519 mm)	3	164	LR1P324V24-03WTemp
27"	24-3/8"(619 mm)	4	195	LR1P324V27-04WTemp
30"	24-3/8"(619 mm)	4	211	LR1P324V30-04WTemp
33"	28-5/16"(719 mm)	5	242	LR1P324V33-05WTemp
36"	32-1/4"(819 mm)	5	258	LR1P324V36-05WTemp
39"	36-3/16"(919 mm)	5	290	LR1P324V39-05WTemp
42"	36-3/16"(919 mm)	6	305	LR1P324V42-06WTemp
45"	40-1/8"(1019 mm)	6	337	LR1P324V45-06WTemp
48"	44-1/16"(1119 mm)	6	353	LR1P324V48-06WTemp



ACCENT Cabinet

12V 120 Lumens/Ft.

Cabinet Width	Fixture Length	Total Watts	Total Lumens	Part Number
9"	6-5/8"(168 mm)	2	53	LR1P312V09-02WTemp
12"	8-5/8"(219 mm)	2	69	LR1P312V12-02WTemp
15"	12-9/16"(319 mm)	2	101	LR1P312V15-02WTemp
18"	14-1/2"(368 mm)	3	116	LR1P312V18-03WTemp
21"	18-7/16"(468 mm)	3	148	LR1P312V21-03WTemp
24"	20-7/16"(519 mm)	3	164	LR1P312V24-03WTemp
27"	24-3/8"(619 mm)	4	195	LR1P312V27-04WTemp
30"	26-5/16"(668 mm)	4	211	LR1P312V30-04WTemp
33"	30-1/4"(768 mm)	5	242	LR1P312V33-05WTemp
36"	32-1/4"(819 mm)	5	258	LR1P312V36-05WTemp
39"	36-3/16"(919 mm)	5	290	LR1P312V39-05WTemp
42"	38-1/8"(968 mm)	6	305	LR1P312V42-06WTemp
45"	42-1/16"(1069 mm)	6	337	LR1P312V45-06WTemp
48"	44-1/16"(1119 mm)	6	353	LR1P312V48-06WTemp



Flat LED Linear Fixtures Tunable-White Lighting

Select a different shade of white for any occasion after lighting is installed. Easy-to-install, fully assembled fixtures.

Mounting clips included

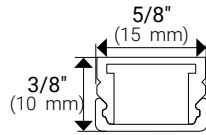

Fixture Cross-Section

Applications

- Under cabinet
- Interior cabinet
- Shelves
- Built-in cabinets
- Laundry rooms
- Outdoor

Tunable-White Kelvin Temperatures



Lumen Output Options



Accessories

Find installation components starting on page 586

About the Product

- Tunable-White lighting from Warm White to Daylight White and all shades of white in between
- Tune the white light and adjust the brightness separately with required wired, wireless controller, (order separately) or smart home device (not included)
- Use for a variety of surface mount applications made easy with mounting clip installation
- Easy to install using the two-wire connectors on either end of the fixture
- Install included mounting clips for quick and easy installation
- 12V or 24V power supply required (order separately)
- Dimmable (with compatible dimmer)
- No Ultraviolet (UV) or Infrared (IR)
- Compatible with WAV Smart Control™ devices
- 50,000 hour LED life at 70% lumen maintenance
- UL Listed



12V and 24V Flat LED Linear Fixtures

Tunable-White Lighting Ordering Information



24V 600 Lumens/Ft.

Cabinet Width	Fixture Length	Total Watts	Total Lumens	Part Number
9"	5-11/16"(145 mm)	3	205	LT6P724V09-03W
12"	8-1/8"(206 mm)	4	293	LT6P724V12-04W
15"	10-5/8"(270 mm)	6	468	LT6P724V15-06W
18"	15-1/2"(394 mm)	7	555	LT6P724V18-07W
21"	18"(457 mm)	9	728	LT6P724V21-09W
24"	20-7/16"(519 mm)	10	815	LT6P724V24-10W
27"	22-7/8"(581 mm)	11	903	LT6P724V27-11W
30"	25-3/8"(645 mm)	13	1078	LT6P724V30-13W
33"	30-1/4"(768 mm)	14	1165	LT6P724V33-14W
36"	32-3/4"(832 mm)	15	1253	LT6P724V36-15W
39"	35-3/16"(894 mm)	17	1428	LT6P724V39-17W
42"	37-5/8"(956 mm)	18	1515	LT6P724V42-18W
45"	42-9/16"(1081 mm)	19	1603	LT6P724V45-19W
48"	45"(1143 mm)	21	1778	LT6P724V48-21W



24V 400 Lumens/Ft.

Cabinet Width	Fixture Length	Total Watts	Total Lumens	Part Number
9"	5-11/16"(145 mm)	3	137	LT4P724V09-03W
12"	8-1/8"(206 mm)	3	195	LT4P724V12-03W
15"	10-5/8"(270 mm)	4	312	LT4P724V15-04W
18"	15-1/2"(394 mm)	5	370	LT4P724V18-05W
21"	18"(457 mm)	6	485	LT4P724V21-06W
24"	20-7/16"(519 mm)	7	543	LT4P724V24-07W
27"	22-7/8"(581 mm)	8	602	LT4P724V27-08W
30"	25-3/8"(645 mm)	9	718	LT4P724V30-09W
33"	30-1/4"(768 mm)	10	777	LT4P724V33-10W
36"	32-3/4"(832 mm)	10	835	LT4P724V36-10W
39"	35-3/16"(894 mm)	12	952	LT4P724V39-12W
42"	37-5/8"(956 mm)	12	1010	LT4P724V42-12W
45"	42-9/16"(1081 mm)	13	1068	LT4P724V45-13W
48"	45"(1143 mm)	14	1185	LT4P724V48-14W



24V 300 Lumens/Ft.

Cabinet Width	Fixture Length	Total Watts	Total Lumens	Part Number
9"	5-1/8"(130 mm)	3	99	LT2P724V09-03W
12"	7-5/16"(186 mm)	3	141	LT2P724V12-03W
15"	11-11/16"(297 mm)	4	226	LT2P724V15-04W
18"	13-7/8"(352 mm)	5	268	LT2P724V18-05W
21"	18-3/16"(462 mm)	6	352	LT2P724V21-06W
24"	20-3/8"(518 mm)	6	394	LT2P724V24-06W
27"	22-9/16"(573 mm)	7	436	LT2P724V27-07W
30"	26-15/16"(684 mm)	8	521	LT2P724V30-08W
33"	29-1/8"(740 mm)	9	563	LT2P724V33-09W
36"	31-5/16"(795 mm)	9	605	LT2P724V36-09W
39"	35-11/16"(906 mm)	10	690	LT2P724V39-10W
42"	37-7/8"(962 mm)	11	732	LT2P724V42-11W
45"	40-1/16"(1018 mm)	11	775	LT2P724V45-11W
48"	44-7/16"(1129 mm)	12	859	LT2P724V48-12W



12V 300 Lumens/Ft.

Cabinet Width	Fixture Length	Total Watts	Total Lumens	Part Number
9"	5-1/8"(130 mm)	3	99	LT2P712V09-03W
12"	7-5/16"(186 mm)	3	141	LT2P712V12-03W
15"	11-11/16"(297 mm)	4	226	LT2P712V15-04W
18"	13-7/8"(352 mm)	5	268	LT2P712V18-05W
21"	18-3/16"(462 mm)	6	352	LT2P712V21-06W
24"	20-3/8"(518 mm)	6	394	LT2P712V24-06W
27"	22-9/16"(573 mm)	7	436	LT2P712V27-07W
30"	26-15/16"(684 mm)	8	521	LT2P712V30-08W
33"	29-1/8"(740 mm)	9	563	LT2P712V33-09W
36"	31-5/16"(795 mm)	9	605	LT2P712V36-09W
39"	35-11/16"(906 mm)	10	690	LT2P712V39-10W
42"	37-7/8"(962 mm)	11	732	LT2P712V42-11W
45"	40-1/16"(1018 mm)	11	775	LT2P712V45-11W
48"	44-7/16"(1129 mm)	12	859	LT2P712V48-12W



Flat LED Linear Fixtures Single-White Lighting

Energize any space with versatile, simple white lighting. Easy-to-install, fully assembled fixtures.

Mounting clips included

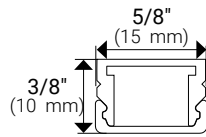

Fixture Cross-Section

Applications

- Under cabinet
- Interior cabinet
- Shelves
- Built-in cabinets
- Laundry rooms
- Outdoor

Kelvin Temperature Options



Lumen Output Options



Accessories

Find installation components starting on page 586

About the Product

- Use for a variety of surface mount applications made easy with mounting clip installation
- Easy to install using the two-wire connectors on either end of the fixture
- Install included mounting clips for quick and easy installation
- 12V or 24V power supply required (order separately)
- Dimmable (with compatible dimmer)
- No Ultraviolet (UV) or Infrared (IR)
- Compatible with WAV Smart Control™ devices
- 50,000 hour LED life at 70% lumen maintenance
- UL Listed



12 and 24V Flat LED Linear Fixtures

Single-White Lighting Ordering Information

Blue indicates dealer choice: Temp indicates Kelvin temperature. LS4P724V09-03W3 (Example part number for 400 lumens/ft 9" fixture in 3000K Kelvin temperature)



HIGHER Cabinet

24V 600 Lumens/Ft.

Cabinet Width	Fixture Length	Total Watts	Total Lumens	Part Number
9"	6-5/8"(168 mm)	3	265	LS6P724V09-03WTemp
12"	8-5/8"(219 mm)	4	345	LS6P724V12-04WTemp
15"	12-9/16"(319 mm)	6	503	LS6P724V15-06WTemp
18"	14-1/2"(368 mm)	7	580	LS6P724V18-07WTemp
21"	18-7/16"(468 mm)	9	738	LS6P724V21-09WTemp
24"	20-7/16"(519 mm)	10	818	LS6P724V24-10WTemp
27"	24-3/8"(619 mm)	12	975	LS6P724V27-12WTemp
30"	26-15/16"(684 mm)	12	1053	LS6P724V30-12WTemp
33"	30-1/4"(768 mm)	14	1210	LS6P724V33-14WTemp
36"	32-1/4"(819 mm)	15	1290	LS6P724V36-15WTemp
39"	36-3/16"(919 mm)	17	1448	LS6P724V39-17WTemp
42"	38-1/8"(968 mm)	18	1525	LS6P724V42-18WTemp
45"	42-1/16"(1018 mm)	20	1683	LS6P724V45-20WTemp
48"	44-1/16"(1119 mm)	21	1763	LS6P724V48-21WTemp



HIGH Cabinet

24V 400 Lumens/Ft.

Cabinet Width	Fixture Length	Total Watts	Total Lumens	Part Number
9"	6-5/8"(168 mm)	3	137	LS4P724V09-03WTemp
12"	8-5/8"(219 mm)	3	195	LS4P724V12-03WTemp
15"	12-9/16"(319 mm)	4	312	LS4P724V15-04WTemp
18"	14-1/2"(368 mm)	5	370	LS4P724V18-05WTemp
21"	18-7/16"(468 mm)	6	485	LS4P724V21-06WTemp
24"	20-7/16"(519 mm)	7	543	LS4P724V24-07WTemp
27"	24-3/8"(619 mm)	8	602	LS4P724V27-08WTemp
30"	26-15/16"(684 mm)	8	718	LS4P724V30-08WTemp
33"	30-1/4"(768 mm)	10	777	LS4P724V33-10WTemp
36"	32-1/4"(819 mm)	10	835	LS4P724V36-10WTemp
39"	36-3/16"(919 mm)	11	952	LS4P724V39-11WTemp
42"	38-1/8"(968 mm)	12	1010	LS4P724V42-12WTemp
45"	42-1/16"(1018 mm)	13	1068	LS4P724V45-13WTemp
48"	44-1/16"(1119 mm)	14	1185	LS4P724V48-14WTemp



STANDARD Cabinet

24V 225 Lumens/Ft.

Cabinet Width	Fixture Length	Total Watts	Total Lumens	Part Number
9"	6-5/8"(168 mm)	3	99	LV2P724V09-03WTemp
12"	8-5/8"(219 mm)	3	129	LV2P724V12-03WTemp
15"	12-9/16"(319 mm)	4	188	LV2P724V15-04WTemp
18"	14-1/2"(368 mm)	5	218	LV2P724V18-05WTemp
21"	18-7/16"(468 mm)	5	277	LV2P724V21-05WTemp
24"	20-7/16"(519 mm)	6	307	LV2P724V24-06WTemp
27"	24-3/8"(619 mm)	7	366	LV2P724V27-07WTemp
30"	26-15/16"(684 mm)	7	395	LV2P724V30-07WTemp
33"	30-1/4"(768 mm)	8	454	LV2P724V33-08WTemp
36"	32-1/4"(819 mm)	9	484	LV2P724V36-09WTemp
39"	36-3/16"(919 mm)	10	543	LV2P724V39-10WTemp
42"	38-1/8"(968 mm)	10	572	LV2P724V42-10WTemp
45"	42-1/16"(1018 mm)	11	631	LV2P724V45-11WTemp
48"	44-1/16"(1119 mm)	12	661	LV2P724V48-12WTemp



STANDARD Cabinet

12V 225 Lumens/Ft.

Cabinet Width	Fixture Length	Total Watts	Total Lumens	Part Number
9"	6-5/8"(168 mm)	3	99	LV2P712V09-03WTemp
12"	8-5/8"(219 mm)	3	129	LV2P712V12-03WTemp
15"	12-9/16"(319 mm)	4	188	LV2P712V15-04WTemp
18"	14-1/2"(368 mm)	5	218	LV2P712V18-05WTemp
21"	18-7/16"(468 mm)	5	277	LV2P712V21-05WTemp
24"	20-7/16"(519 mm)	6	307	LV2P712V24-06WTemp
27"	24-3/8"(619 mm)	7	366	LV2P712V27-07WTemp
30"	26-15/16"(684 mm)	7	395	LV2P712V30-07WTemp
33"	30-1/4"(768 mm)	8	454	LV2P712V33-08WTemp
36"	32-1/4"(819 mm)	9	484	LV2P712V36-09WTemp
39"	36-3/16"(919 mm)	10	543	LV2P712V39-10WTemp
42"	38-1/8"(968 mm)	10	572	LV2P712V42-10WTemp
45"	42-1/16"(1018 mm)	11	631	LV2P712V45-11WTemp
48"	44-1/16"(1119 mm)	12	661	LV2P712V48-12WTemp



ACCENT Cabinet

24V 120 Lumens/Ft.

Cabinet Width	Fixture Length	Total Watts	Total Lumens	Part Number
9"	4-11/16"(119 mm)	2	53	LR1P724V09-02WTemp
12"	8-5/8"(219 mm)	2	69	LR1P724V12-02WTemp
15"	12-9/16"(319 mm)	2	101	LR1P724V15-02WTemp
18"	12-9/16"(319 mm)	3	116	LR1P724V18-03WTemp
21"	16-1/2"(419 mm)	3	148	LR1P724V21-03WTemp
24"	20-7/16"(519 mm)	3	164	LR1P724V24-03WTemp
27"	24-3/8"(619 mm)	4	195	LR1P724V27-04WTemp
30"	24-3/8"(619 mm)	4	211	LR1P724V30-04WTemp
33"	28-5/16"(719 mm)	5	242	LR1P724V33-05WTemp
36"	32-1/4"(819 mm)	5	258	LR1P724V36-05WTemp
39"	36-3/16"(919 mm)	5	290	LR1P724V39-05WTemp
42"	36-3/16"(919 mm)	6	305	LR1P724V42-06WTemp
45"	40-1/8"(1019 mm)	6	337	LR1P724V45-06WTemp
48"	44-1/16"(1119 mm)	6	353	LR1P724V48-06WTemp



ACCENT Cabinet

12V 120 Lumens/Ft.

Cabinet Width	Fixture Length	Total Watts	Total Lumens	Part Number
9"	6-5/8"(168 mm)	2	53	LR1P712V09-02WTemp
12"	8-5/8"(219 mm)	2	69	LR1P712V12-02WTemp
15"	12-9/16"(319 mm)	2	101	LR1P712V15-02WTemp
18"	14-1/2"(368 mm)	3	116	LR1P712V18-03WTemp
21"	18-7/16"(468 mm)	3	148	LR1P712V21-03WTemp
24"	20-7/16"(519 mm)	3	164	LR1P712V24-03WTemp
27"	24-3/8"(619 mm)	4	195	LR1P712V27-04WTemp
30"	26-5/16"(668 mm)	4	211	LR1P712V30-04WTemp
33"	30-1/4"(768 mm)	5	242	LR1P712V33-05WTemp
36"	32-1/4"(819 mm)	5	258	LR1P712V36-05WTemp
39"	36-3/16"(919 mm)	5	290	LR1P712V39-05WTemp
42"	38-1/8"(968 mm)	6	305	LR1P712V42-06WTemp
45"	42-1/16"(1068 mm)	6	337	LR1P712V45-06WTemp
48"	44-1/16"(1119 mm)	6	353	LR1P712V48-06WTemp



Recessed LED Linear Fixtures Tunable-White Lighting

Select a different shade of white for any occasion after lighting is installed. Easy-to-install, fully assembled fixtures.

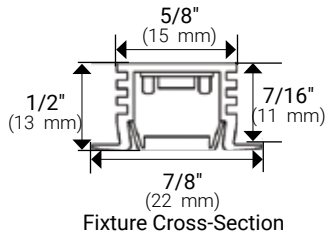

Applications

- Interior cabinet
- Stairs
- Closet

Tunable-White Kelvin Temperatures

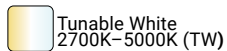

Lumen Output Options



Accessories

Find installation components starting on page 586

About the Product

- Tunable-White lighting from Warm White to Daylight White and all shades of white in between
- Tune the white light and adjust the brightness separately with required wired, wireless controller, (order separately) or smart home device (not included)
- Use for a flush-mount installation under cabinets or shelves
- Easy to install using the two-wire connectors on either end of the fixture
- 12V or 24V power supply required (order separately)
- Dimmable (with compatible dimmer)
- No Ultraviolet (UV) or Infrared (IR)
- 5/8" router recommended for recessed fixture
- Compatible with WAV Smart Control™ devices
- 50,000 hour LED life at 70% lumen maintenance
- UL Listed



12V and 24V Recessed LED Linear Fixtures

Tunable-White Lighting Ordering Information



24V 600 Lumens/Ft.

Cabinet Width	Fixture Length	Total Watts	Total Lumens	Part Number
9"	5-1/8"(130 mm)	3	205	LT6PX24V09-03W
12"	7-5/16"(186 mm)	4	293	LT6PX24V12-04W
15"	11-11/16"(297 mm)	6	468	LT6PX24V15-06W
18"	13-7/8"(352 mm)	7	555	LT6PX24V18-07W
21"	18-3/16"(462 mm)	9	728	LT6PX24V21-09W
24"	20-3/8"(518 mm)	10	815	LT6PX24V24-10W
27"	22-9/16"(573 mm)	11	903	LT6PX24V27-11W
30"	26-15/16"(684 mm)	13	1078	LT6PX24V30-13W
33"	29-1/8"(740 mm)	14	1165	LT6PX24V33-14W
36"	31-5/16"(795 mm)	15	1253	LT6PX24V36-15W
39"	35-11/16"(906 mm)	17	1428	LT6PX24V39-17W
42"	37-7/8"(962 mm)	18	1515	LT6PX24V42-18W
45"	40-1/16"(1018 mm)	19	1603	LT6PX24V45-19W
48"	44-7/16"(1129 mm)	21	1778	LT6PX24V48-21W



24V 400 Lumens/Ft.

Cabinet Width	Fixture Length	Total Watts	Total Lumens	Part Number
9"	5-11/16"(145 mm)	3	137	LT4PX24V09-03W
12"	8-1/8"(206 mm)	3	195	LT4PX24V12-03W
15"	10-5/8"(270 mm)	4	312	LT4PX24V15-04W
18"	15-1/2"(394 mm)	5	370	LT4PX24V18-05W
21"	18"(457 mm)	6	485	LT4PX24V21-06W
24"	20-7/16"(519 mm)	7	543	LT4PX24V24-07W
27"	22-7/8"(581 mm)	8	602	LT4PX24V27-08W
30"	25-3/8"(645 mm)	9	718	LT4PX24V30-09W
33"	30-1/4"(768 mm)	10	777	LT4PX24V33-10W
36"	32-3/4"(832 mm)	10	835	LT4PX24V36-10W
39"	35-3/16"(894 mm)	12	952	LT4PX24V39-12W
42"	37-5/8"(956 mm)	12	1010	LT4PX24V42-12W
45"	42-9/16"(1081 mm)	13	1068	LT4PX24V45-13W
48"	45"(1143 mm)	14	1185	LT4PX24V48-14W



24V 300 Lumens/Ft.

Cabinet Width	Fixture Length	Total Watts	Total Lumens	Part Number
9"	5-1/8"(130 mm)	3	99	LT2PX24V09-03W
12"	7-5/16"(186 mm)	3	141	LT2PX24V12-03W
15"	11-11/16"(297 mm)	4	226	LT2PX24V15-04W
18"	13-7/8"(352 mm)	5	268	LT2PX24V18-05W
21"	18-3/16"(462 mm)	6	352	LT2PX24V21-06W
24"	20-3/8"(518 mm)	6	394	LT2PX24V24-06W
27"	22-9/16"(573 mm)	7	436	LT2PX24V27-07W
30"	26-15/16"(684 mm)	8	521	LT2PX24V30-08W
33"	29-1/8"(740 mm)	9	563	LT2PX24V33-09W
36"	31-5/16"(795 mm)	9	605	LT2PX24V36-09W
39"	35-11/16"(906 mm)	10	690	LT2PX24V39-10W
42"	37-7/8"(962 mm)	11	732	LT2PX24V42-11W
45"	40-1/16"(1018 mm)	11	775	LT2PX24V45-11W
48"	44-7/16"(1129 mm)	12	859	LT2PX24V48-12W



12V 300 Lumens/Ft.

Cabinet Width	Fixture Length	Total Watts	Total Lumens	Part Number
9"	5-1/8"(130 mm)	3	99	LT2PX12V09-03W
12"	7-5/16"(186 mm)	3	141	LT2PX12V12-03W
15"	11-11/16"(297 mm)	4	226	LT2PX12V15-04W
18"	13-7/8"(352 mm)	5	268	LT2PX12V18-05W
21"	18-3/16"(462 mm)	6	352	LT2PX12V21-06W
24"	20-3/8"(518 mm)	6	394	LT2PX12V24-06W
27"	22-9/16"(573 mm)	7	436	LT2PX12V27-07W
30"	26-15/16"(684 mm)	8	521	LT2PX12V30-08W
33"	29-1/8"(740 mm)	9	563	LT2PX12V33-09W
36"	31-5/16"(795 mm)	9	605	LT2PX12V36-09W
39"	35-11/16"(906 mm)	10	690	LT2PX12V39-10W
42"	37-7/8"(962 mm)	11	732	LT2PX12V42-11W
45"	40-1/16"(1018 mm)	11	775	LT2PX12V45-11W
48"	44-7/16"(1129 mm)	12	859	LT2PX12V48-12W



Recessed LED Linear Fixtures Single-White Lighting

Energize any space with versatile, simple white lighting. Easy-to-install, fully assembled fixtures.

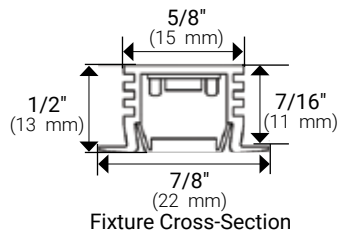

Applications

- Interior cabinet
- Stairs
- Closet

Kelvin Temperature Options



Lumen Output Options



Accessories

Find installation components starting on page 586

About the Product

- Use for a flush-mount installation under cabinets or shelves
- Easy to install using the two-wire connectors on either end of the fixture
- 12V or 24V power supply required (order separately)
- Dimmable (with compatible dimmer)
- No Ultraviolet (UV) or Infrared (IR)
- 5/8" router recommended for recessed fixture
- Compatible with WAV Smart Control™ devices
- 50,000 hour LED life at 70% lumen maintenance
- UL Listed



12 and 24V Recessed LED Linear Fixtures

Single-White Lighting Ordering Information

Blue indicates dealer choice: Temp indicates Kelvin temperature. LS4P724V09-03W3 (Example part number for 400 lumens/ft 9" fixture in 3000K Kelvin temperature)



HIGHER Cabinet

24V 600 Lumens/Ft.

Cabinet Width	Fixture Length	Total Watts	Total Lumens	Part Number
9"	6-5/8"(168 mm)	3	265	LS6PX24V09-03WTemp
12"	8-5/8"(219 mm)	4	345	LS6PX24V12-04WTemp
15"	12-9/16"(319 mm)	6	503	LS6PX24V15-06WTemp
18"	14-1/2"(368 mm)	7	580	LS6PX24V18-07WTemp
21"	18-7/16"(468 mm)	9	738	LS6PX24V21-09WTemp
24"	20-7/16"(519 mm)	10	818	LS6PX24V24-10WTemp
27"	24-3/8"(619 mm)	12	975	LS6PX24V27-12WTemp
30"	26-15/16"(684 mm)	12	1053	LS6PX24V30-12WTemp
33"	30-1/4"(768 mm)	14	1210	LS6PX24V33-14WTemp
36"	32-1/4"(819 mm)	15	1290	LS6PX24V36-15WTemp
39"	36-3/16"(919 mm)	17	1448	LS6PX24V39-17WTemp
42"	38-1/8"(968 mm)	18	1525	LS6PX24V42-18WTemp
45"	42-1/16"(1018 mm)	20	1683	LS6PX24V45-20WTemp
48"	44-1/16"(1119 mm)	21	1763	LS6PX24V48-21WTemp



HIGH Cabinet

24V 400 Lumens/Ft.

Cabinet Width	Fixture Length	Total Watts	Total Lumens	Part Number
9"	6-5/8"(168 mm)	3	137	LS4PX24V09-03WTemp
12"	8-5/8"(219 mm)	3	195	LS4PX24V12-03WTemp
15"	12-9/16"(319 mm)	4	312	LS4PX24V15-04WTemp
18"	14-1/2"(368 mm)	5	370	LS4PX24V18-05WTemp
21"	18-7/16"(468 mm)	6	485	LS4PX24V21-06WTemp
24"	20-7/16"(519 mm)	7	543	LS4PX24V24-07WTemp
27"	24-3/8"(619 mm)	8	602	LS4PX24V27-08WTemp
30"	26-15/16"(684 mm)	8	718	LS4PX24V30-08WTemp
33"	30-1/4"(768 mm)	10	777	LS4PX24V33-10WTemp
36"	32-1/4"(819 mm)	10	835	LS4PX24V36-10WTemp
39"	36-3/16"(919 mm)	11	952	LS4PX24V39-11WTemp
42"	38-1/8"(968 mm)	12	1010	LS4PX24V42-12WTemp
45"	42-1/16"(1018 mm)	13	1068	LS4PX24V45-13WTemp
48"	44-1/16"(1119 mm)	14	1185	LS4PX24V48-14WTemp



STANDARD Cabinet

24V 225 Lumens/Ft.

Cabinet Width	Fixture Length	Total Watts	Total Lumens	Part Number
9"	6-5/8"(168 mm)	3	99	LV2PX24V09-03WTemp
12"	8-5/8"(219 mm)	3	129	LV2PX24V12-03WTemp
15"	12-9/16"(319 mm)	4	188	LV2PX24V15-04WTemp
18"	14-1/2"(368 mm)	5	218	LV2PX24V18-05WTemp
21"	18-7/16"(468 mm)	5	277	LV2PX24V21-05WTemp
24"	20-7/16"(519 mm)	6	307	LV2PX24V24-06WTemp
27"	24-3/8"(619 mm)	7	366	LV2PX24V27-07WTemp
30"	26-15/16"(684 mm)	7	395	LV2PX24V30-07WTemp
33"	30-1/4"(768 mm)	8	454	LV2PX24V33-08WTemp
36"	32-1/4"(819 mm)	9	484	LV2PX24V36-09WTemp
39"	36-3/16"(919 mm)	10	543	LV2PX24V39-10WTemp
42"	38-1/8"(968 mm)	10	572	LV2PX24V42-10WTemp
45"	42-1/16"(1018 mm)	11	631	LV2PX24V45-11WTemp
48"	44-1/16"(1119 mm)	12	661	LV2PX24V48-12WTemp



STANDARD Cabinet

12V 225 Lumens/Ft.

Cabinet Width	Fixture Length	Total Watts	Total Lumens	Part Number
9"	6-5/8"(168 mm)	3	99	LV2PX12V09-03WTemp
12"	8-5/8"(219 mm)	3	129	LV2PX12V12-03WTemp
15"	12-9/16"(319 mm)	4	188	LV2PX12V15-04WTemp
18"	14-1/2"(368 mm)	5	218	LV2PX12V18-05WTemp
21"	18-7/16"(468 mm)	5	277	LV2PX12V21-05WTemp
24"	20-7/16"(519 mm)	6	307	LV2PX12V24-06WTemp
27"	24-3/8"(619 mm)	7	366	LV2PX12V27-07WTemp
30"	26-15/16"(684 mm)	7	395	LV2PX12V30-07WTemp
33"	30-1/4"(768 mm)	8	454	LV2PX12V33-08WTemp
36"	32-1/4"(819 mm)	9	484	LV2PX12V36-09WTemp
39"	36-3/16"(919 mm)	10	543	LV2PX12V39-10WTemp
42"	38-1/8"(968 mm)	10	572	LV2PX12V42-10WTemp
45"	42-1/16"(1018 mm)	11	631	LV2PX12V45-11WTemp
48"	44-1/16"(1119 mm)	12	661	LV2PX12V48-12WTemp



ACCENT Cabinet

24V 120 Lumens/Ft.

Cabinet Width	Fixture Length	Total Watts	Total Lumens	Part Number
9"	4-11/16"(119 mm)	2	53	LR1PX24V09-02WTemp
12"	8-5/8"(219 mm)	2	69	LR1PX24V12-02WTemp
15"	12-9/16"(319 mm)	2	101	LR1PX24V15-02WTemp
18"	12-9/16"(319 mm)	3	116	LR1PX24V18-03WTemp
21"	16-1/2"(419 mm)	3	148	LR1PX24V21-03WTemp
24"	20-7/16"(519 mm)	3	164	LR1PX24V24-03WTemp
27"	24-3/8"(619 mm)	4	195	LR1PX24V27-04WTemp
30"	24-3/8"(619 mm)	4	211	LR1PX24V30-04WTemp
33"	28-5/16"(719 mm)	5	242	LR1PX24V33-05WTemp
36"	32-1/4"(819 mm)	5	258	LR1PX24V36-05WTemp
39"	36-3/16"(919 mm)	5	290	LR1PX24V39-05WTemp
42"	36-3/16"(919 mm)	6	305	LR1PX24V42-06WTemp
45"	40-1/8"(1019 mm)	6	337	LR1PX24V45-06WTemp
48"	44-1/16"(1119 mm)	6	353	LR1PX24V48-06WTemp



ACCENT Cabinet

12V 120 Lumens/Ft.

Cabinet Width	Fixture Length	Total Watts	Total Lumens	Part Number
9"	6-5/8"(168 mm)	2	53	LR1PX12V09-02WTemp
12"	8-5/8"(219 mm)	2	69	LR1PX12V12-02WTemp
15"	12-9/16"(319 mm)	2	101	LR1PX12V15-02WTemp
18"	14-1/2"(368 mm)	3	116	LR1PX12V18-03WTemp
21"	18-7/16"(468 mm)	3	148	LR1PX12V21-03WTemp
24"	20-7/16"(519 mm)	3	164	LR1PX12V24-03WTemp
27"	24-3/8"(619 mm)	4	195	LR1PX12V27-04WTemp
30"	26-5/16"(668 mm)	4	211	LR1PX12V30-04WTemp
33"	30-1/4"(768 mm)	5	242	LR1PX12V33-05WTemp
36"	32-1/4"(819 mm)	5	258	LR1PX12V36-05WTemp
39"	36-3/16"(919 mm)	5	290	LR1PX12V39-05WTemp
42"	38-1/8"(968 mm)	6	305	LR1PX12V42-06WTemp
45"	42-1/16"(1068 mm)	6	337	LR1PX12V45-06WTemp
48"	44-1/16"(1119 mm)	6	353	LR1PX12V48-06WTemp

LED Cut-To-Length Program

LED Tape Lighting and Linear Fixtures cut to custom size

Find the perfect white light Kelvin temperature and light output, then place an order to have our team in Kearney, Nebraska cut to the specified length and assemble as a fixture for a quick installation.



Have our team prepare tailored tape lighting or linear fixtures for any application

Keep it simple with LED tape lighting, or add in an aluminum profile with a frosted lens to create a fully-assembled fixture. We offer options in lumen output, profile style, Kelvin temperature, and length—ordering with the Cut-to-Length program is as simple as 1–2–3! Find ordering information on the following pages.



Custom lighting made easy

Choice-driven lighting

Choose tape light or fixture type, then length, Kelvin temperature, and output—control with wireless, wired, or smart home systems.



Custom doesn't mean difficult

Lean on our team of designers and technicians—simply tell us what you need and let us guide you to the right options.

Peace of mind

Any product customized by Task Lighting maintains the same warranties and life expectancy of all our standard options.



Cut-to-Length Program Tape Lighting & Linear Fixtures

Easy to order and install pre-cut tape lighting or custom sized preassembled fixtures for any sized project.

Step 1 Choose desired lumen output

Tunable-White and Single-White lighting in 12-volt and 24-volt options

Tape Light Type	Description
600 Lumens/Ft. 24V Tunable-White Lighting	Higher light output, 600 lumens per foot, 24-volt tunable-white lighting featuring patented TandemLED™ technology (2700K–5000K), 5.5-watts per foot. See page 526 for more details on this tape light.
600 Lumens/Ft. 24V Single-White Lighting	Higher light output, 600 lumens per foot, 24-volt single-white lighting available in Soft White 3000K and Cool White 4000K, 5.5-watts per foot. See page 528 for more details on this tape light.
400 Lumens/Ft. 24V Tunable-White Lighting	High light output, 400 lumens per foot, 24-volt tunable-white lighting featuring patented TandemLED™ technology (2700K–5000K), 3.8-watts per foot. See page 526 for more details on this tape light.
400 Lumens/Ft. 24V Single-White Lighting	High light output, 400 lumens per foot, 24-volt single-white lighting available in Soft White 3000K and Cool White 4000K, 3.5-watts per foot. See page 528 for more details on this tape light.
300 Lumens/Ft. 24V Tunable-White Lighting	Standard light output, 400 lumens per foot, 24-volt tunable-white lighting featuring patented TandemLED™ technology (2700K–5000K), 2.93-watts per foot. See page 526 for more details on this tape light.
300 Lumens/Ft. 12V Tunable-White Lighting	Standard light output, 400 lumens per foot, 12-volt tunable-white lighting featuring patented TandemLED™ technology (2700K–5000K), 2.93-watts per foot. See page 526 for more details on this tape light.
225 Lumens/Ft. 24V Single-White Lighting	Standard light output, 225 lumens per foot, 24-volt single-white lighting available in Soft White 3000K and Cool White 4000K, 2.8-watts per foot. See page 528 for more details on this tape light.
225 Lumens/Ft. 12V Single-White Lighting	Standard light output, 225 lumens per foot, 12-volt single-white lighting available in Soft White 3000K and Cool White 4000K, 2.8-watts per foot. See page 528 for more details on this tape light.
120 Lumens/Ft. 24V Single-White Lighting	Accent light output, 120 lumens per foot, 24-volt single-white lighting available in Soft White 3000K and Cool White 4000K, 1.5-watts per foot. See page 528 for more details on this tape light.
120 Lumens/Ft. 12V Single-White Lighting	Accent light output, 120 lumens per foot, 12-volt single-white lighting available in Soft White 3000K and Cool White 4000K, 1.5-watts per foot. See page 528 for more details on this tape light.

Kelvin Temperature Options



Tunable-White Kelvin Temperatures



Cut-to-Length Program

Tunable-White and Single-White Lighting Options

Step 2 Choose an aluminum profile or select tape light only

NOTE: frosted lens on the aluminum profile reduces the light output slightly, but disperses light evenly.

Profile Type	Description
No profile	White EZ screw-down connectors on both ends of tape light
Premium Flat—designed for surface mount application	White EZ screw-down on both sides of fixture, mounting bracket available (order separately)
Dual-Mount—designed for surface or recess mount application	White EZ screw-down on both sides of fixture, mounting clips available (order separately)
Flat—designed for surface mount application	White EZ screw-down on both sides of fixture, mounting clips available (order separately)
Angled—designed for in cabinet application	White EZ screw-down on both sides of fixture, mounting clips available (order separately)
Shallow Recessed—designed for thin shelf applications	2 ft. wire leads on both sides of fixture
Recessed—designed for shelf or frameless cabinet installation	White EZ screw-down on both sides of fixture

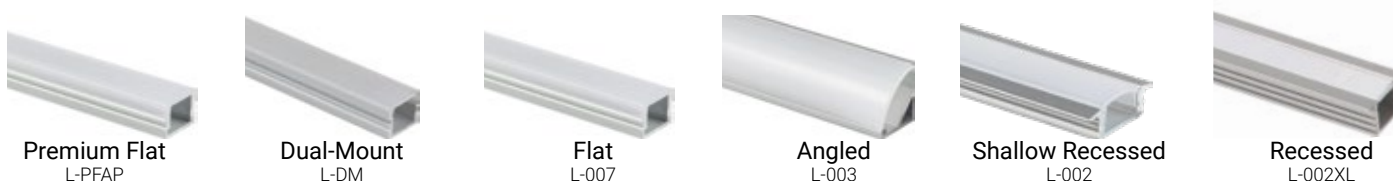

Step 3 Choose the length of tape light or fixture desired

Tape lighting and fixtures in aluminum profiles are available from 5" minimum to 90" maximum length

Tape Light Type	Cut Lengths	Kelvin Temperature Options
600 Lumens/Ft. 24V Tunable-White	Approximately 2" intervals	Warm White 2700K to Daylight White 5000K and all white in between
600 Lumens/Ft. 24V Single-White	Approximately 2" intervals	Soft White 3000K (3) or Cool White 4000K (4)
400 Lumens/Ft. 24V Tunable-White	Approximately 2" intervals	Warm White 2700K to Daylight White 5000K and all white in between
400 Lumens/Ft. 24V Single-White	Approximately 2" intervals	Soft White 3000K (3) or Cool White 4000K (4)
300 Lumens/Ft. 24V Tunable-White	Approximately 2" intervals	Warm White 2700K to Daylight White 5000K and all white in between
300 Lumens/Ft. 12V Tunable-White	Approximately 1" intervals	Warm White 2700K to Daylight White 5000K and all white in between
225 Lumens/Ft. 24V Single-White	Approximately 2" intervals	Soft White 3000K (3) or Cool White 4000K (4)
225 Lumens/Ft. 12V Single-White	Approximately 1" intervals	Soft White 3000K (3) or Cool White 4000K (4)
120 Lumens/Ft. 24V Single-White	Approximately 4" intervals	Soft White 3000K (3) or Cool White 4000K (4)
120 Lumens/Ft. 12V Single-White	Approximately 2" intervals	Soft White 3000K (3) or Cool White 4000K (4)

Ready to order?

To order Cut-to-Length fixtures call Design Services at **866-848-9094** or email **DesignAndSupport@TaskLighting.com**. Get connected with one of our friendly in-house Design Services team members to order fixtures to your exact length requirements.



LIVE SUPPORT!

ACCESSORIES

Find installation components on page 586



STANDARD **12V 300 Lumens/Ft.**
(234 lumens/ft. in profile with frosted lens)

Description	Part Number
300 lumens/ft. tape light, no profile	ODL-TMW-BNK
300 lumens/ft. tape light, dual-mount profile with a frosted lens	ODL-TMW-PFAP
300 lumens/ft. tape light, dual-mount profile with a frosted lens	ODL-TMW-DMF
300 lumens/ft. tape light, 007 flat profile with a frosted lens	ODL-TMW-007F
300 lumens/ft. tape light, 003 angled profile with a frosted lens	ODL-TMW-003F
300 lumens/ft. tape light, 002 recessed profile with a frosted lens	ODL-TMW-002F
300 lumens/ft. tape light, 002XL deep recessed profile with a frosted lens	ODL-TMW-RSF



STANDARD **24V 300 Lumens/Ft.**
(234 lumens/ft. in profile with frosted lens)

Description	Part Number
300 lumens/ft. tape light, no profile	ODL-24-T3-BNK
300 lumens/ft. tape light, dual-mount profile with a frosted lens	ODL-24-T3-PFAP
300 lumens/ft. tape light, dual-mount profile with a frosted lens	ODL-24-T3-DMF
300 lumens/ft. tape light, 007 flat profile with a frosted lens	ODL-24-T3-007F
300 lumens/ft. tape light, 003 angled profile with a frosted lens	ODL-24-T3-003F
300 lumens/ft. tape light, 002 recessed profile with a frosted lens	ODL-24-T3-002F
300 lumens/ft. tape light, 002XL deep recessed profile with a frosted lens	ODL-24-T3-RSF



HIGH **24V 400 Lumens/Ft.**
(250 lumens/ft. in profile with frosted lens)

Description	Part Number
400 lumens/ft. tape light, no profile	ODL-24-T4-BNK
400 lumens/ft. tape light, dual-mount profile with a frosted lens	ODL-24-T4-PFAP
400 lumens/ft. tape light, dual-mount profile with a frosted lens	ODL-24-T4-DMF
400 lumens/ft. tape light, 007 flat profile with a frosted lens	ODL-24-T4-007F
400 lumens/ft. tape light, 003 angled profile with a frosted lens	ODL-24-T4-003F
400 lumens/ft. tape light, 002 recessed profile with a frosted lens	ODL-24-T4-002F
400 lumens/ft. tape light, 002XL deep recessed profile with a frosted lens	ODL-24-T4-RSF



HIGHER **24V 600 Lumens/Ft.**
(370 lumens/ft. in profile with frosted lens)

Description	Part Number
600 lumens/ft. tape light, no profile	ODL-24-T6-BNK
600 lumens/ft. tape light, dual-mount profile with a frosted lens	ODL-24-T6-PFAP
600 lumens/ft. tape light, dual-mount profile with a frosted lens	ODL-24-T6-DMF
600 lumens/ft. tape light, 007 flat profile with a frosted lens	ODL-24-T6-007F
600 lumens/ft. tape light, 003 angled profile with a frosted lens	ODL-24-T6-003F
600 lumens/ft. tape light, 002 recessed profile with a frosted lens	ODL-24-T6-002F
600 lumens/ft. tape light, 002XL deep recessed profile with a frosted lens	ODL-24-T6-RSF



Single-White Lighting Options

 **ACCENT 12V** 120 Lumens/Ft. (101 lumens/ft. in profile with frosted lens)

Description	Part Number
120 lumens/ft. tape light, no profile	ODL-RMW-BNK-Temp
120 lumens/ft. tape light, dual-mount profile with a frosted lens	ODL-RMW-PFAP-Temp
120 lumens/ft. tape light, dual-mount profile with a frosted lens	ODL-RMW-DMF-Temp
120 lumens/ft. tape light, 007 flat profile with a frosted lens	ODL-RMW-007F-Temp
120 lumens/ft. tape light, 003 angled profile with a frosted lens	ODL-RMW-003F-Temp
120 lumens/ft. tape light, 002 recessed profile with a frosted lens	ODL-RMW-002F-Temp
120 lumens/ft. tape light, 002XL deep recessed profile with a frosted lens	ODL-RMW-RSF-Temp

 **STANDARD 12V** 225 Lumens/Ft. (188 lumens/ft. in profile with frosted lens)

Description	Part Number
225 lumens/ft. tape light, no profile	ODL-VMW-BNK-Temp
225 lumens/ft. tape light, dual-mount profile with a frosted lens	ODL-VMW-PFAP-Temp
225 lumens/ft. tape light, dual-mount profile with a frosted lens	ODL-VMW-DMF-Temp
225 lumens/ft. tape light, 007 flat profile with a frosted lens	ODL-VMW-007F-Temp
225 lumens/ft. tape light, 003 angled profile with a frosted lens	ODL-VMW-003F-Temp
225 lumens/ft. tape light, 002 recessed profile with a frosted lens	ODL-VMW-002F-Temp
225 lumens/ft. tape light, 002XL deep recessed profile with a frosted lens	ODL-VMW-RSF-Temp

 **ACCENT 24V** 120 Lumens/Ft. (101 lumens/ft. in profile with frosted lens)

Description	Part Number
120 lumens/ft. tape light, no profile	ODL-R24-BNK-Temp
120 lumens/ft. tape light, dual-mount profile with a frosted lens	ODL-R24-PFAP-Temp
120 lumens/ft. tape light, dual-mount profile with a frosted lens	ODL-R24-DMF-Temp
120 lumens/ft. tape light, 007 flat profile with a frosted lens	ODL-R24-007F-Temp
120 lumens/ft. tape light, 003 angled profile with a frosted lens	ODL-R24-003F-Temp
120 lumens/ft. tape light, 002 recessed profile with a frosted lens	ODL-R24-002F-Temp
120 lumens/ft. tape light, 002XL deep recessed profile with a frosted lens	ODL-R24-RSF-Temp

 **STANDARD 24V** 225 Lumens/Ft. (188 lumens/ft. in profile with frosted lens)

Description	Part Number
225 lumens/ft. tape light, no profile	ODL-V24-BNK-Temp
225 lumens/ft. tape light, dual-mount profile with a frosted lens	ODL-V24-PFAP-Temp
225 lumens/ft. tape light, dual-mount profile with a frosted lens	ODL-V24-DMF-Temp
225 lumens/ft. tape light, 007 flat profile with a frosted lens	ODL-V24-007F-Temp
225 lumens/ft. tape light, 003 angled profile with a frosted lens	ODL-V24-003F-Temp
225 lumens/ft. tape light, 002 recessed profile with a frosted lens	ODL-V24-002F-Temp
225 lumens/ft. tape light, 002XL deep recessed profile with a frosted lens	ODL-V24-RSF-Temp

 **HIGH 24V** 400 Lumens/Ft. (250 lumens/ft. in profile with frosted lens)

Description	Part Number
400 lumens/ft. tape light, no profile	ODL-24S4-BNK-Temp
400 lumens/ft. tape light, dual-mount profile with a frosted lens	ODL-24S4-PFAP-Temp
400 lumens/ft. tape light, dual-mount profile with a frosted lens	ODL-24S4-DMF-Temp
400 lumens/ft. tape light, 007 flat profile with a frosted lens	ODL-24S4-007F-Temp
400 lumens/ft. tape light, 003 angled profile with a frosted lens	ODL-24S4-003F-Temp
400 lumens/ft. tape light, 002 recessed profile with a frosted lens	ODL-24S4-002F-Temp
400 lumens/ft. tape light, 002XL deep recessed profile with a frosted lens	ODL-24S4-RSF-Temp

 **HIGHER 24V** 600 Lumens/Ft. (370 lumens/ft. in profile with frosted lens)

Description	Part Number
600 lumens/ft. tape light, no profile	ODL-24S6-BNK-Temp
600 lumens/ft. tape light, dual-mount profile with a frosted lens	ODL-24S6-PFAP-Temp
600 lumens/ft. tape light, dual-mount profile with a frosted lens	ODL-24S6-DMF-Temp
600 lumens/ft. tape light, 007 flat profile with a frosted lens	ODL-24S6-007F-Temp
600 lumens/ft. tape light, 003 angled profile with a frosted lens	ODL-24S6-003F-Temp
600 lumens/ft. tape light, 002 recessed profile with a frosted lens	ODL-24S6-002F-Temp
600 lumens/ft. tape light, 002XL deep recessed profile with a frosted lens	ODL-24S6-RSF-Temp

LED Tape Lighting Kits

Elevate designs with LED tape lighting

All-in-the-box tape light kits make selecting lighting and components easy. Simply determine the number of Zones and Areas, then choose from a variety of light color temperatures, controllers, and power supplies.



Featured: 225 lumens/foot single-white LED tape lighting kit

Create this look with one tape lighting kit:

LED Tape Lighting Kit



LED Tape Lighting Kits made easy

Everything included in the box

Each kit contains everything needed for a full LED tape lighting installation. Eliminate the hassle of forgetting to order components and ensure professional-grade results.

Kit options for every space

From full kitchen installs to bathrooms and pantries, there is a kit for spaces large to small. Choose from a variety of Kelvin temperatures, controller types, and power supply options.

Expect easy installation

Cut the LED tape lighting into segments matching what is needed and then connect to power and control with the included EZ screw-down connectors. The screwdriver even comes in the box!

Zones

In a lighting project, a zone is a location requiring a separate **dimming receiver** to turn different lighting applications on/off or dim at separate times.

A multiple-zone project includes lighting that should be controlled separately, such as under the cabinet and inside glass door cabinets.

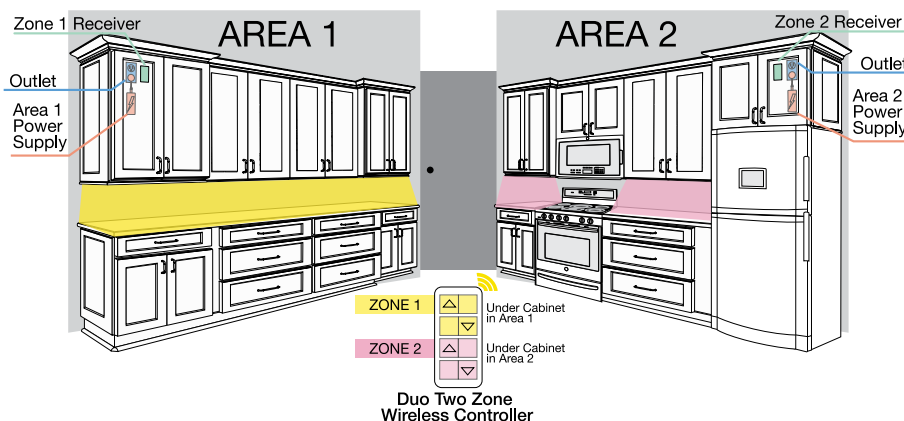
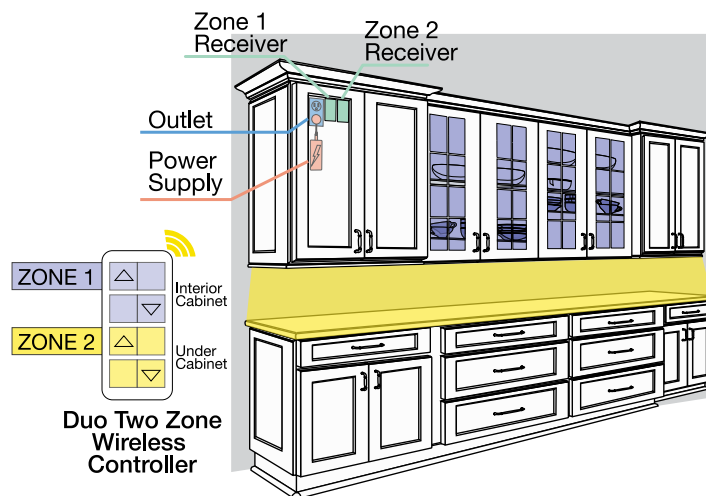

Areas

In a lighting project, an area is a location requiring a separate **power supply**. Areas can be set to all turn on/off and dim at the same time or separately.

An example of a project with more than one area is when wire cannot be run across the entire space to be lit due to an obstruction, such as a doorway.

Tunable-White LED Lighting with TandemLED™ Technology

12-Volt, 300 Lumens/Ft. LED Tape Lighting

One box with all components needed to install tunable-white LED lighting; power supply and control system included.



Field cuttable approximately every 1.1"



About The Product

- Tunable-white lighting from Warm White to Daylight White and all shades of white in between
- Tune the white light and adjust the brightness separately with included Wired or Wireless Controller
- Easy to cut and reconnect in the field with included screw-down connectors
- Exceptional color rendering of 90+ CRI (Color Rendering Index)
- IP65 rated micro-waterproof coating for indoor/outdoor applications
- Dimmable (with compatible dimmer)
- WAV Smart Control™ compatible for smart home connection (L-TK1Z1A-16 kit)
- Aluminum housings with frosted or clear lens available for clean installation (order separately)
- No Ultraviolet (UV) or Infrared (IR)
- 3M™ 300LSE waterproof adhesive tape
- 50,000 hour LED life at 70% lumen maintenance
- UL Listed

Lumen Output



STANDARD

Applications

- Kitchens
- Bathrooms
- Closets
- Laundry Rooms
- Outdoor spaces

Tunable-White Kelvin Temperatures

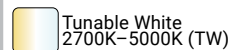

LED Specifications

LED Beam Angle 120°



Scan to view installation video

<https://delivr.com/2nxye>



12V LED Tape Light Kits—Tunable-White Lighting

300 Lumens/Ft.



12V

300 Lumens/Ft. 12-Volt LED Tape Lighting Kit Wireless Controller Kit: 1 Zone, 1 Area, smart home compatible

Wireless Controller Kit
1 Zone, 1 Area, Smart home compatible
L-TK1Z1A-16

QTY	Description	Component Part Numbers
1	16.4 ft. roll, 12-volt, 300 lumens/ft. tunable-white LED tape lighting with patented TandemLED™ Technology, cuttable approximately every 1"	L-T600-16-MW
1	Tunable-white wireless RF controller for on/off, dimming, and white color temperature tuning, one-zone	T-T1Z-WC-RF-WT
1	White decora-style wall plate (option for mounting controller)	T-DPL-WT
1	WAV Smart Receiver/Power Supply, 60-watts maximum, 12-volt DC	T-TWAV-PSR-60W
1	Female barrel connector	T-FBC
1	25 ft. roll 20-2 gauge in-wall rated stranded connection wire	T-CW20G-STR-25
2	Tape light-to-wire screw-down connector (12 pieces total)	L-EZV2-6PK-WT
1	Task Lighting multi-bit screwdriver	T-TOOL-SD1
1	3M™ adhesion wipe for prepping mounting surface	L-APW-4298



12V

300 Lumens/Ft. 12-Volt LED Tape Lighting Kit Wired Controller Kit: 1 Zone, 1 Area, not smart home compatible

Wired Controller Kit
1 Zone, 1 Area, (not smart home compatible)
L-TWCK-16

QTY	Description	Component Part Numbers
1	16.4 ft. roll, 12-volt, 300 lumens/ft. tunable-white LED tape lighting with patented TandemLED™ technology, cuttable approximately every 1"	L-T600-16-MW
1	Tunable-white wired controller for on/off, dimming, and white color temperature tuning (96-watts)	T-TIL-96
1	12-volt, 60-watt plug-in power supply	T-60W-12V-PI
1	Female barrel connector	T-FBC
1	25 ft. roll 20-2 gauge in-wall rated stranded connection wire	T-CW20G-STR-25
2	Tape light-to-wire screw-down connector (12 pieces total)	L-EZV2-6PK-WT
1	Task Lighting multi-bit screwdriver	T-TOOL-SD1
1	3M™ adhesion wipe for prepping mounting surface	L-APW-4298



Example: Basic Tunable-White Lighting Wireless Kit Wiring Diagram

- Step 1.** Connect receiver/power supply to tape light → **Step 2.** Pair receiver/power supply to wireless controller or smart home hub → **Step 3.** Plug receiver/power supply into wall outlet

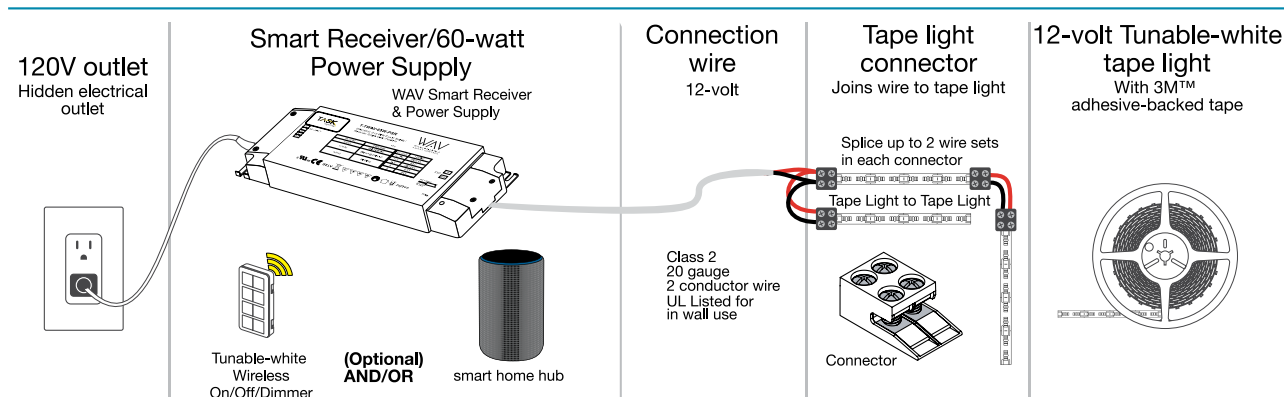



Single-White LED Lighting Wireless Controller Kits

12-Volt, 225 Lumens/Ft. LED Tape Lighting

One box with all components needed to install single-white LED lighting; power supply and control system included.



Field cuttable approximately every 1"



About the Product

- Easy to cut and reconnect in the field with included screw-down connectors
- Wireless dimming system for easy lighting control
- IP65 rated micro-waterproof coating for indoor/outdoor applications
- No Ultraviolet (UV) or Infrared (IR)
- 50,000 hour LED life at 70% lumen maintenance
- UL listed

Lumen Output



STANDARD

Applications

- Kitchens
- Bathrooms
- Closets
- Laundry Rooms
- Outdoor spaces

Kelvin Temperature Options

- | | | | |
|--|--------------------------|--|------------------------------|
| | Warm White
2700K (27) | | Soft White
3000K (30) |
| | Cool White
4000K (40) | | Daylight White
5000K (50) |

LED Specifications

LED Beam Angle 120°

Example: Basic Single-White Wireless Kit Hookup Diagram

Step 1. Connect Power Supply to Receiver

Step 2. Connect Receiver to Tape Light

Step 3. Mount Tape Light and Pair Controller

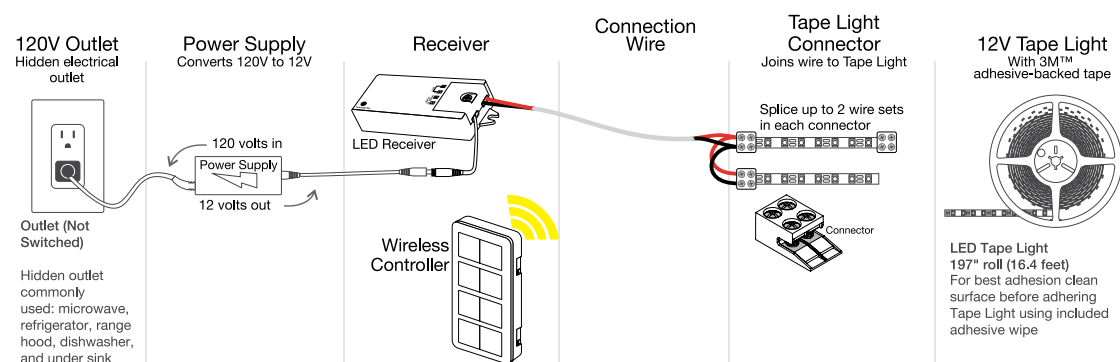

12V LED Tape Light Kits–Wireless Controller

225 Lumens/Ft.



225 Lumens/Ft. 12-volt, 16 ft. LED Tape Lighting Kit One-Zone Wireless Controller Kit: 1 Zone, 1 Area

**One-Zone Wireless
Controller Kit**
1 Zone, 1 Area,
16 ft. Single-White
LED tape lighting
L-VUK1Z1A-16-Temp

QTY	Description	Component Part Numbers
1	16.4 ft. roll, 12-volt, 225 lumens/ft. single-white LED tape lighting, cuttable approximately every 1"	L-VMW600-16
1	One zone wireless RF controller for on/off/dimming	T-Q-1Z-WC-RF-WT
1	White decora-style wall plate (option for mounting controller)	T-DPL-WT
1	Receiver (12-volt, 96-watt maximum)	T-Q-WR96
1	12-volt, 60-watt plug-in power supply	T-60W-12V-PI
1	Female barrel connector	T-FBC
1	25 ft. roll 20-2 gauge in-wall rated stranded connection wire	T-CW20G-STR-25
2	Tape light-to-wire screw-down connector (12 pieces total)	L-EZV2-6PK-WT
1	Task Lighting multi-bit screwdriver	T-TOOL-SD1
1	3M™ adhesion wipe for prepping mounting surface	L-APW-4298



225 Lumens/Ft. 12-volt, 16 ft. LED Tape Lighting Kit Two-Zone Wireless Controller Kit: 2 Zone, 2 Area

**Two-Zone Wireless
Controller Kit**
2 Zone, 2 Area,
16 ft. Single-White
LED tape lighting
L-VK2Z2A-16-Temp

QTY	Description	Component Part Numbers
1	16.4 ft. roll, 12-volt, 225 lumens/ft. single-white LED tape lighting, cuttable approximately every 1"	L-VMW600-16
1	Two zone wireless RF controller for on/off/dimming	T-Q-2Z-WC-RF-WT
1	White decora-style wall plate (option for mounting controller)	T-DPL-WT
2	Receiver (12-volt, 96-watt maximum)	T-Q-WR96
2	12-volt, 60-watt plug-in power supply	T-60W-12V-PI
1	Female barrel connector	T-FBC
1	50 ft. roll 20-2 gauge in-wall rated stranded connection wire	T-CW20G-STR-50
3	Tape light-to-wire screw-down connector (18 pieces total)	L-EZV2-6PK-WT
1	Task Lighting multi-bit screwdriver	T-TOOL-SD1
2	3M™ adhesion wipe for prepping mounting surface	L-APW-4298



225 Lumens/Ft. 12-volt, 32 ft. LED Tape Lighting Kit Two-Zone Wireless Controller Kit: 2 Zone, 2 Area

**Two-Zone Wireless
Controller Kit**
2 Zone, 2 Area,
32 ft. Single-White
LED tape lighting
L-VK2Z2A-32-Temp

QTY	Description	Component Part Numbers
2	16.4 ft. roll, 12-volt, 225 lumens/ft. single-white LED tape lighting, cuttable approximately every 1"	L-VMW600-16
1	Two zone wireless RF controller for on/off/dimming	T-Q-2Z-WC-RF-WT
1	White decora-style wall plate (option for mounting controller)	T-DPL-WT
2	Receiver (12-volt, 96-watt maximum)	T-Q-WR96
2	12-volt, 60-watt plug-in power supply	T-60W-12V-PI
1	Female barrel connector	T-FBC
1	50 ft. roll 20-2 gauge in-wall rated stranded connection wire	T-CW20G-STR-50
3	Tape light-to-wire screw-down connector (18 pieces total)	L-EZV2-6PK-WT
1	Task Lighting multi-bit screwdriver	T-TOOL-SD1
2	3M™ adhesion wipe for prepping mounting surface	L-APW-4298



Scan to view installation video
<https://delivr.com/2d8p8>





Single-White LED Lighting Wireless Controller Kits (continued)

12-Volt, 225 Lumens/Ft. LED Tape Lighting

One box with all components needed to install single-white LED lighting; power supply and control system included.



Field cuttable approximately every 1"



About the Product

- Easy to cut and reconnect in the field with included screw-down connectors
- Wireless dimming system for easy lighting control
- IP65 rated micro-waterproof coating for indoor/outdoor applications
- No Ultraviolet (UV) or Infrared (IR)
- 50,000 hour LED life at 70% lumen maintenance
- UL listed

Lumen Output



Applications

- Kitchens
- Bathrooms
- Closets
- Laundry Rooms
- Outdoor spaces

Kelvin Temperature Options

- Warm White 2700K (27)
- Soft White 3000K (30)
- Cool White 4000K (40)
- Daylight White 5000K (50)

LED Specifications

LED Beam Angle 120°

Example: Basic Single-White Wireless Kit Hookup Diagram

- Step 1.** Connect Power Supply to Receiver → **Step 2.** Connect Receiver to Tape Light → **Step 3.** Mount Tape Light and Pair Controller

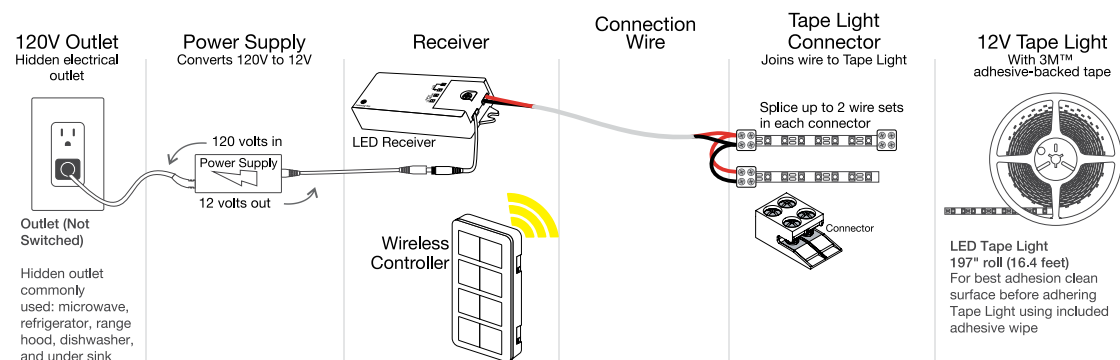

12V LED Tape Light Kits–Wireless Controller

225 Lumens/Ft.



225 Lumens/Ft. 12-volt, 16 ft. LED Tape Lighting Kit Four-Zone Wireless Controller Kit: 1 Zone, 1 Area

QTY	Description	Component Part Numbers
1	16.4 ft. roll, 12-volt, 225 lumens/ft. single-white LED tape lighting, cuttable approximately every 1"	L-VMW600-16
1	Four zone wireless RF controller for on/off/dimming	T-Q-4Z-WC-RF-WT
1	White decora-style wall plate (option for mounting controller)	T-DPL-WT
1	Receiver (12-volt, 96-watt maximum)	T-Q-WR96
1	12-volt, 60-watt plug-in power supply	T-60W-12V-PI
1	Female barrel connector	T-FBC
1	25 ft. roll 20-2 gauge in-wall rated stranded connection wire	T-CW20G-STR-25
2	Tape light-to-wire screw-down connector (12 pieces total)	L-EZV2-6PK-WT
1	Task Lighting multi-bit screwdriver	T-TOOL-SD1
1	3M™ adhesion wipe for prepping mounting surface	L-APW-4298

Four-Zone Wireless Controller Kit
1 Zone, 1 Area,
16 ft. Single-White LED tape lighting
L-VK1Z1A-16-Temp



225 Lumens/Ft. 12-volt, 49 ft. LED Tape Lighting Kit Four-Zone Wireless Controller Kit: 3 Zone, 3 Area

QTY	Description	Component Part Numbers
3	16.4 ft. roll, 12-volt, 225 lumens/ft. single-white LED tape lighting, cuttable approximately every 1"	L-VMW600-16
1	Four zone wireless RF controller for on/off/dimming	T-Q-4Z-WC-RF-WT
1	White decora-style wall plate (option for mounting controller)	T-DPL-WT
3	Receiver (12-volt, 96-watt maximum)	T-Q-WR96
3	12-volt, 60-watt plug-in power supply	T-60W-12V-PI
1	Female barrel connector	T-FBC
1	100 ft. roll 20-2 gauge in-wall rated stranded connection wire	T-CW20G-STR-100
4	Tape light-to-wire screw-down connector (24 pieces total)	L-EZV2-6PK-WT
1	Task Lighting multi-bit screwdriver	T-TOOL-SD1
3	3M™ adhesion wipe for prepping mounting surface	L-APW-4298

Four-Zone Wireless Controller Kit
3 Zone, 3 Area,
49 ft. Single-White LED tape lighting
L-VK3Z3A-49-Temp



225 Lumens/Ft. 12-volt, 65 ft. LED Tape Lighting Kit Four-Zone Wireless Controller Kit: 4 Zone, 4 Area

QTY	Description	Component Part Numbers
4	16.4 ft. roll, 12-volt, 225 lumens/ft. single-white LED tape lighting, cuttable approximately every 1"	L-VMW600-16
1	Four zone wireless RF controller for on/off/dimming	T-Q-4Z-WC-RF-WT
1	White decora-style wall plate (option for mounting controller)	T-DPL-WT
4	Receiver (12-volt, 96-watt maximum)	T-Q-WR96
2	12-volt, 96-watt plug-in power supply	T-96W-12V-PI
2	12-volt, 60-watt plug-in power supply	T-60W-12V-PI
4	Female barrel connector	T-FBC
1	100 ft. roll 20-2 gauge in-wall rated stranded connection wire	T-CW20G-STR-100
5	Tape light-to-wire screw-down connector (30 pieces total)	L-EZV2-6PK-WT
1	Task Lighting multi-bit screwdriver	T-TOOL-SD1
4	3M™ adhesion wipe for prepping mounting surface	L-APW-4298

Four-Zone Wireless Controller Kit
4 Zone, 4 Area,
65 ft. Single-White LED tape lighting
L-VK4Z4A-65-Temp



Scan to view installation video
<https://delivr.com/2d8p8>





Single-White LED Lighting Wireless Controller Kit

12-Volt, 120 Lumens/Ft. LED Tape Lighting

One box with all components needed to install single-white LED lighting; power supply and control system included.



Field cuttable approximately every 2"







Applications

- Kitchens
- Bathrooms
- Closets
- Laundry Rooms
- Outdoor spaces

About the Product

- Easy to cut and reconnect in the field with included screw-down connectors
- Wireless dimming system for easy lighting control
- IP65 rated micro-waterproof coating for indoor/outdoor applications
- No Ultraviolet (UV) or Infrared (IR)
- 50,000 hour LED life at 70% lumen maintenance
- UL listed

Kelvin Temperature Options

- | | |
|---|---|
|  Warm White 2700K (27) |  Soft White 3000K (30) |
|  Cool White 4000K (40) |  Daylight White 5000K (50) |

Lumen Output



LED Specifications

LED Beam Angle 120°

Example: Basic Single-White Wireless Kit Hookup Diagram

- Step 1.** Connect power supply to receiver → **Step 2.** Connect receiver to tape light → **Step 3.** Mount tape light and pair controller

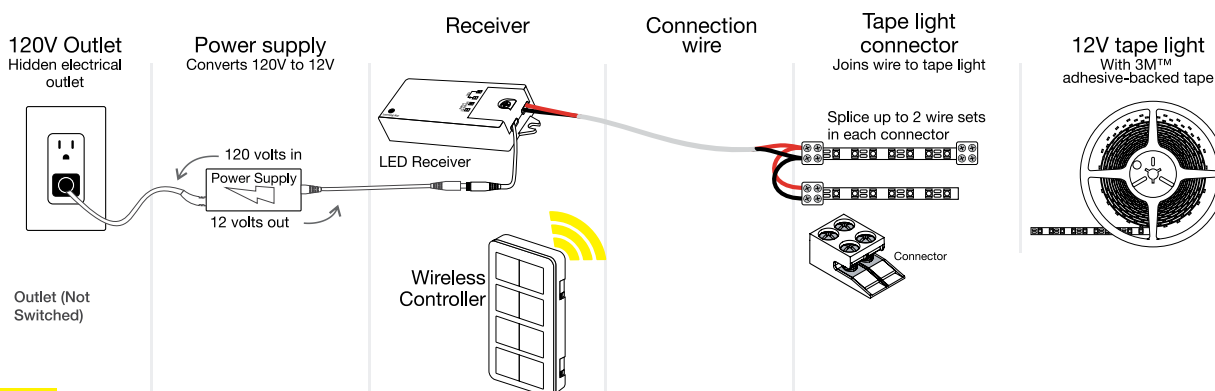

12V LED Tape Light Kits–Wireless Controller

120 Lumens/Ft. and expansion packs



12V

120 Lumens/Ft. 12-volt, 16 ft. LED Tape Lighting Kit One-Zone Wireless Controller Kit: 1 Zone, 1 Area

**One-Zone Wireless Controller Kit
1 Zone, 1 Area,
16 ft. Single-White LED tape lighting
L-RK1Z1A-16-Temp**

QTY	Description	Component Part Numbers
1	16.4 ft. roll, 12-volt, 120 lumens/ft. single-white LED tape lighting, cuttable approximately every 2"	L-RMW300-16
1	One zone wireless RF controller for on/off/dimming	T-Q-1Z-WC-RF-WT
1	White decora-style wall plate (option for mounting controller)	T-DPL-WT
1	Receiver (12-volt, 96-watt maximum)	T-Q-WR96
1	12-volt, 60-watt plug-in power supply	T-60W-12V-PI
1	Female barrel connector	T-FBC
1	25 ft. roll 20-2 gauge in-wall rated stranded connection wire	T-CW20G-STR-25
2	Tape light-to-wire screw-down connector (12 pieces total)	L-EZV2-6PK-WT
1	Task Lighting multi-bit screwdriver	T-TOOL-SD1
1	3M™ adhesion wipe for prepping mounting surface	L-APW-4298



LED TAPE LIGHTING KIT EXPANSION PACKS

12V Expansion Pack to add a zone: Single-White Wireless Controller Kits (not for smart home compatible kits)

	QTY	Description	Component Part Numbers
Add a Zone	1	Receiver (12-volt, 96 watt maximum)	T-Q-WR96
L-Q-EP1Z	1	Tape light-to-wire screw-down connector (12 pieces total)	L-EZV2-6PK-WT



12V Expansion Pack to add an area: Single-White Wireless Controller Kits (not for smart home compatible kits)

	QTY	Description	Component Part Numbers
Add an Area or a Zone	1	Receiver (12-volt, 96 watt maximum)	T-Q-WR96
L-Q-EP1Z1A	1	Tape light-to-wire screw-down connector (6 pieces total)	L-EZV2-6PK-WT
	1	12-volt, 60-watt plug-in power supply	T-60W-12V-PI





Single-White LED Lighting Touch Dimmer Kits

12-Volt, 120 and 225 Lumens/Ft. LED Tape Lighting

One box with all components needed to install single-white LED lighting; power supply and control system included.



Field cuttable approximately every 1"



Field cuttable approximately every 2"



Applications

- Kitchens
- Bathrooms
- Closets
- Laundry Rooms
- Outdoor spaces

About the Product

- Easy to cut and reconnect in the field with included screw-down connectors
- Wireless dimming system for easy lighting control
- IP65 rated micro-waterproof coating for indoor/outdoor applications
- No Ultraviolet (UV) or Infrared (IR)
- 50,000 hour LED life at 70% lumen maintenance
- UL listed

Kelvin Temperature Options

- | | | | |
|--|--------------------------|--|------------------------------|
| | Warm White
2700K (27) | | Soft White
3000K (30) |
| | Cool White
4000K (40) | | Daylight White
5000K (50) |

Lumen Output



LED Specifications

LED Beam Angle 120°

Example: Basic Single-White Touch Dimmer Kit Hookup Diagram

Step 1. Connect Power Supply to Touch Dimmer

Step 2. Connect Touch Dimmer to Tape Light

Step 3. Mount Touch Dimmer and Tape Light

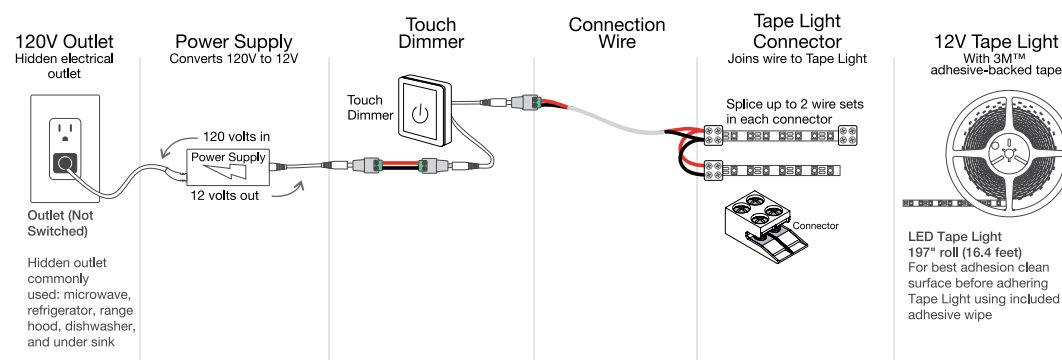

12V LED Tape Light Kits—Touch Dimmer

225 Lumens/Ft. and 120 Lumens/Ft.



12V

225 Lumens/Ft. 12-volt, 16 ft. LED Tape Lighting Kit Touch Dimmer Kit—1 Zone, 1 Area

Touch Dimmer Kit
16 ft. Single-White
LED tape lighting
L-VTDK-16-Temp

QTY	Description	Component Part Numbers
1	16.4 ft. roll, 12-volt, 225 lumens/ft. single-white LED tape lighting, cuttable approximately every 1"	L-VMW600-16
1	Touch Dimmer Switch for on/off and dimming (60 watt)	T-TDS-60W
1	12-volt, 60-watt plug-in power supply	T-60W-12V-PI
2	Female barrel connector	T-FBC
2	Male barrel connector	T-MBC
1	25 ft. roll 20-2 gauge in-wall rated stranded connection wire	T-CW20G-STR-25
2	Tape light-to-wire screw-down connector (12 pieces total)	L-EZV2-6PK-WT
1	Task Lighting multi-bit screwdriver	T-TOOL-SD1
1	3M™ adhesion wipe for prepping mounting surface	L-APW-4298



12V

120 Lumens/Ft. 12-volt, 16 ft. LED Tape Lighting Kit Touch Dimmer Kit—1 Zone, 1 Area

Touch Dimmer Kit
16 ft. Single-White
LED tape lighting
L-RTDK-16-Temp

QTY	Description	Component Part Numbers
1	16.4 ft. roll, 12-volt, 120 lumens/ft. single-white LED tape lighting, cuttable approximately every 2"	L-RMW300-16
1	Touch Dimmer Switch for on/off/dimming (60-watt)	T-TDS-60W
1	12-volt, 24-watt plug-in power supply	T-24W-12V-PI
2	Female barrel connector	T-FBC
2	Male barrel connector	T-MBC
1	25 ft. roll 20-2 gauge in-wall rated stranded connection wire	T-CW20G-STR-25
2	Tape light-to-wire screw-down connector (12 pieces total)	L-EZV2-6PK-WT
1	Task Lighting multi-bit screwdriver	T-TOOL-SD1
1	3M™ adhesion wipe for prepping mounting surface	L-APW-4298



Scan to view installation video
<https://delivr.com/2vk42>





Multi-Color RGB LED Lighting Wireless Controller Kit

12-Volt, 130 Lumens/Ft. LED Tape Lighting

One box with all components needed to install multi-color RGB LED lighting; power supply and control system included.



Field cuttable approximately every 2"



About the Product

- Easy to cut and reconnect in the field with improved snap connectors
- Wireless dimming system for easy lighting control
- IP65 rated micro-waterproof coating for indoor/outdoor applications
- No Ultraviolet (UV) or Infrared (IR)
- 50,000 hour LED life at 70% lumen maintenance
- UL listed

Applications

- Kitchens
- Bathrooms
- Closets
- Laundry Rooms
- Outdoor spaces

LED Specifications

LED Beam Angle 120°

Lumen Output



Scan to view installation video
<https://delivr.com/2v6by>



12V

130 Lumens/Ft. 12-volt LED Tape Lighting Kit Wireless Controller Kit—1 Zone, 1 Area

**Wireless
Controller Kit
1 Zone, 1 Area,
16 ft. Multi-color
LED tape lighting
L-RGBK1Z1A-16**

QTY	Description	Component Part Numbers
1	16.4 ft. roll, 12-volt, 130 lumens/ft. multi-color RGB LED tape lighting, cuttable approximately every 2"	L-RGB-M300-16
1	One zone RGB wireless RF controller for on/off, dimming, and color changing	T-C-RGBWC-RF-WT
1	White decora-style wall plate (option for mounting controller)	T-DPL-WT
1	RGB receiver (12-volt, 180-watt maximum)	T-C-RGB180
1	12-volt, 60-watt plug-in power supply	T-60W-12V-PI
1	Female barrel connector	T-FBC
1	25 ft. roll 4-wire in-wall rated stranded connection wire	L-RGB-4C-WIRE
6	RGB LED tape light to 4-wire connectors (6 pieces total)	L-10MM-RGB-WTT
1	Task Lighting multi-bit screwdriver	T-TOOL-SD1
1	3M™ adhesion wipe for prepping mounting surface	L-APW-4298



Single-White LED Lighting Motion Activated Vanity Night Light Kit

12-Volt, 120 Lumens/Ft. LED Tape Lighting

One box with all components needed to install single-white LED lighting; power supply and control system included.

Field cuttable approximately every 2"



Applications

- Bathrooms
- Closets
- Laundry Rooms

About the Product

- Easy to cut and reconnect in the field with included screw-down connectors
- Motion sensor with Doppler technology for detecting motion to turn lights on/off
- Easily install sensor in a vanity to hide out of sight while still detecting motion through up to 2" vanity cabinet panels
- IP65 rated micro-waterproof coating for indoor/outdoor applications
- No Ultraviolet (UV) or Infrared (IR)
- 50,000 hour LED life at 70% lumen maintenance
- UL listed

LED Specifications

LED Beam Angle 120°

Lumen Output



Scan to view installation video
<https://delivr.com/2qc4h>

Kelvin Temperature



12V

120 Lumens/Ft. 12-volt, 60" LED Tape Lighting Kit Doppler Motion Sensor Switch Kit—1 Zone, 1 Area

	QTY	Description	Component Part Numbers
Vanity Night Light Kit 60 In. Single-white LED tape lighting L-VNLK-05-40	1	60", 12-volt, 120 lumens/ft. single-white LED tape lighting, cuttable approximately every 2"	L-RMW300-16
	1	Doppler motion sensor switch (72-watt)	T-MSS-D-TS
	1	12-volt, 12-watt plug-in power supply	T-12W-12V-PI
	1	Female barrel connector	T-FBC
	8	8 ft. roll 20-2 gauge in-wall rated stranded connection wire	T-CW20G-STR-1
	1	Tape light-to-wire screw-down connector (6 pieces total)	L-EZV2-6PK-WT
	1	Task Lighting multi-bit screwdriver	T-TOOL-SD1
	1	3M™ adhesion wipe for prepping mounting surface	L-APW-4298



LED Specialty Lighting

Get creative with specialty lighting

Use puck lights to create dramatic effects in designs, Flexible Sheet Light for memorable backlighting, Lighted Closet Rod fixtures to make clothing selection easy, and 120V Bar Lights for bright, under cabinet lighting for active spaces.



Featured: 120-Volt Bar Light

Easy to build lighting system:

120V Bar Light
L-BL18-WT-TW



Lighting Control
DVLV-600P-WT



LED Specialty Lighting made easy

Lasting impressions, memorable effects

Enhance a closet with lighted closet rod fixtures, or make entire countertops and backsplashes glow with flexible sheet light.

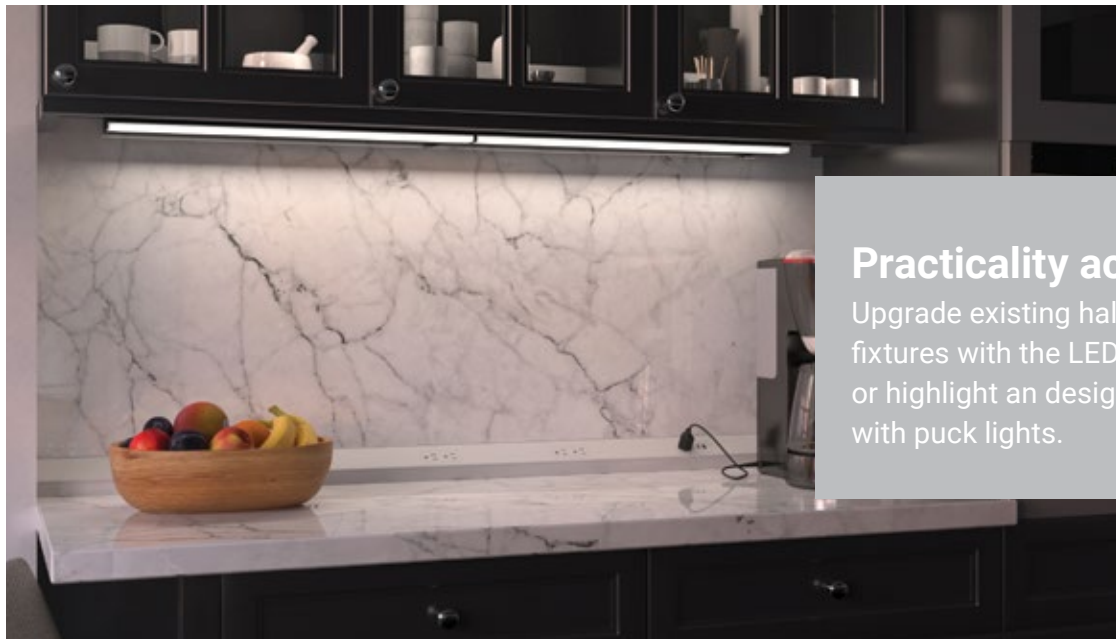

Practicality achieved

Upgrade existing halogen or fluorescent fixtures with the LED 120-Volt Bar Light or highlight a design feature or area with puck lights.

Specialty doesn't mean hard

Our professional team of designers and technicians can lay out a specialty lighting project as quickly and efficiently as using any of our other products.

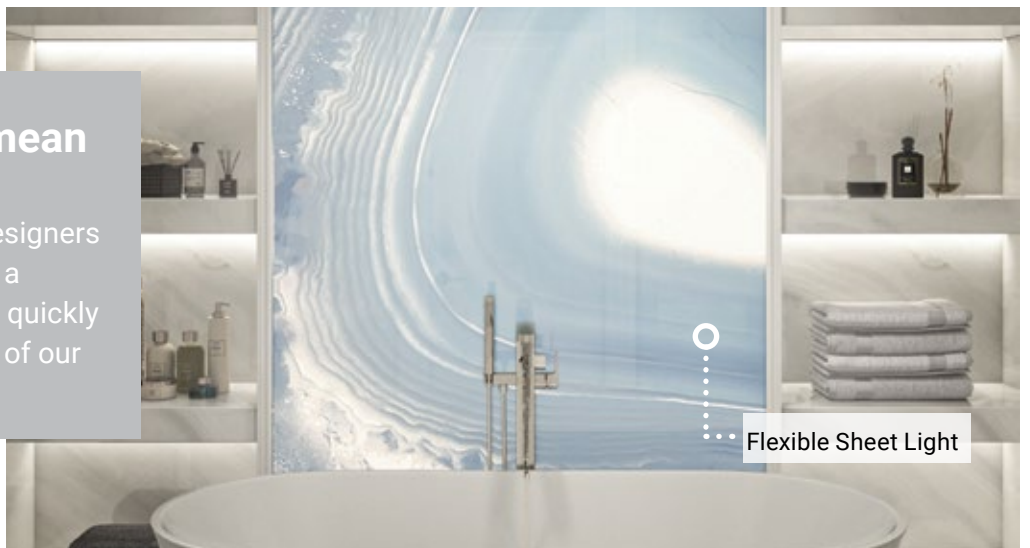

Flexible Sheet Light

24-Volt LED Lighted Closet Rod Tunable-White Lighting

It's easy to find the right outfit when the lighting matches the occasion. Adjust the lighting from warm to cool shades of white to suit the user's preference.

About the Product

- Flange set included with each Lighted Closet Rod
- Each end is field trimmable up to 3"
- Fully assembled fixture
- Dimmable (with compatible dimmer)
- **Accessories sold separately:** WireWay and Center Bracket Support (recommended every 48"), see page 596 & 597
- 24-volt DC plug-in or hardwired power supply required (order separately)
- 90+ CRI (Color Rendering Index)
- No Ultraviolet (UV) or Infrared (IR)
- 50,000 hour LED life at 70% lumen maintenance
- UL Listed

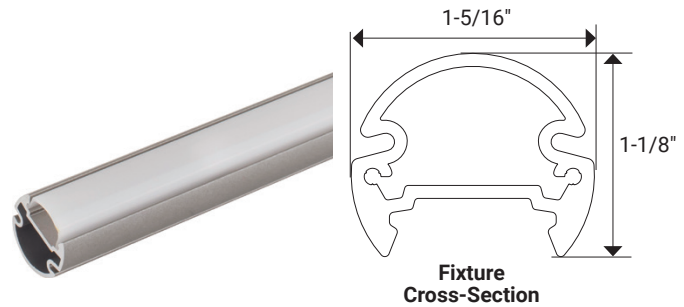

Available Finish Options



Tunable-White Kelvin Temperatures

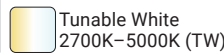

LED Specifications

LED Beam Angle: 120°

Accessories

Find installation components starting on page 586

Applications

- Closet
- Laundry Room

Lumen Output



STANDARD **24V** 300 Lumens/Fixture

Fixture Length	Watts Per Fixture	Lumens Per Fixture	Part Number
18" (457 mm)	3	210	LCR18-T3-03W Finish
24" (610 mm)	5	315	LCR24-T3-05W Finish
30" (762 mm)	6	420	LCR30-T3-06W Finish
36" (914 mm)	8	525	LCR36-T3-08W Finish
42" (1067 mm)	9	630	LCR42-T3-09W Finish
48" (1219 mm)	11	735	LCR48-T3-11W Finish
54" (1372 mm)	12	840	LCR54-T3-12W Finish
60" (1524 mm)	14	945	LCR60-T3-14W Finish
66" (1676 mm)	15	1050	LCR66-T3-15W Finish
72" (1829 mm)	17	1155	LCR72-T3-17W Finish
78" (1981 mm)	18	1260	LCR78-T3-18W Finish
84" (2134 mm)	20	1365	LCR84-T3-20W Finish
90" (228 mm)	21	1470	LCR90-T3-21W Finish

Blue indicates dealer choice: **Finish** indicates Finish Color. **Temp** indicates Kelvin Temperature.
 LCR18-T3-03WBK (Example part number for 18" Lighted Closet Rod with Black finish with tunable-white lighting)

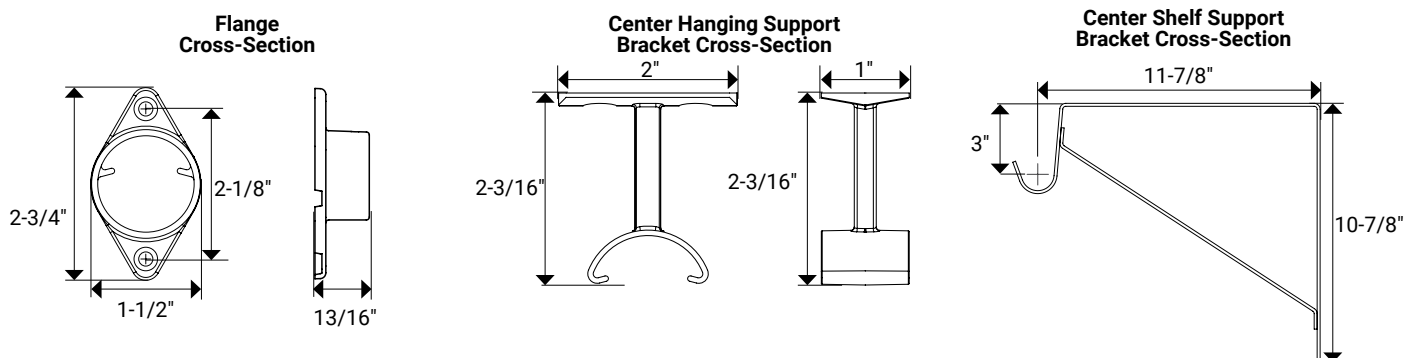

24-Volt LED Lighted Closet Rod Single-White Lighting

Create a luxury experience and illuminate outfits in a closet.

About the Product

- Flange set included with each Lighted Closet Rod
- Each end is field trimmable up to 3"
- Fully assembled fixture
- Dimmable (with compatible dimmer)
- **Accessories sold separately:** WireWay and Center Bracket Support (recommended every 48"), see page 596 & 597
- 24-volt DC plug-in or hardwired power supply required (order separately)
- 90+ CRI (Color Rendering Index)
- No Ultraviolet (UV) or Infrared (IR)
- 50,000 hour LED life at 70% lumen maintenance
- UL Listed

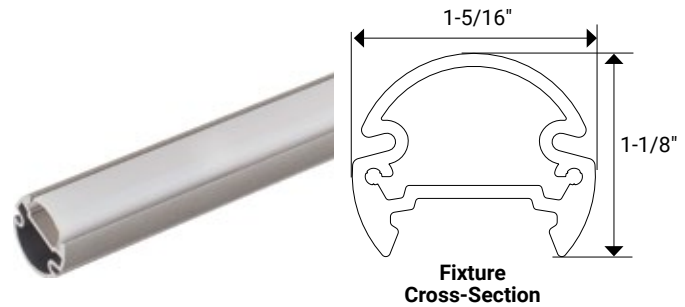

Applications

- Closet
- Laundry Room

Lumen Output



Available Finish Options



Kelvin Temperature Options

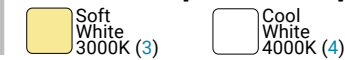

LED Specifications

LED Beam Angle: 120°

Accessories

Find installation components starting on page 586



STANDARD **24V** 225 Lumens/Fixture

Fixture Length	Watts Per Fixture	Lumens Per Fixture	Part Number
18" (457 mm)	3	158	LCR18-S2-03W Finish Temp
24" (610 mm)	5	237	LCR24-S2-05W Finish Temp
30" (762 mm)	6	316	LCR30-S2-06W Finish Temp
36" (914 mm)	8	395	LCR36-S2-08W Finish Temp
42" (1067 mm)	9	474	LCR42-S2-09W Finish Temp
48" (1219 mm)	11	553	LCR48-S2-11W Finish Temp
54" (1372 mm)	12	632	LCR54-S2-12W Finish Temp
60" (1524 mm)	14	711	LCR60-S2-14W Finish Temp
66" (1676 mm)	15	790	LCR66-S2-15W Finish Temp
72" (1829 mm)	17	869	LCR72-S2-17W Finish Temp
78" (1981 mm)	18	948	LCR78-S2-18W Finish Temp
84" (2134 mm)	20	1027	LCR84-S2-20W Finish Temp
90" (228 mm)	21	1106	LCR90-S2-21W Finish Temp

Blue indicates dealer choice: **Finish** indicates Finish Color. **Temp** indicates Kelvin Temperature.
 LCR18-S2-03W**BK3** (Example part number for 18" Lighted Closet Rod with Black finish in 3000K)

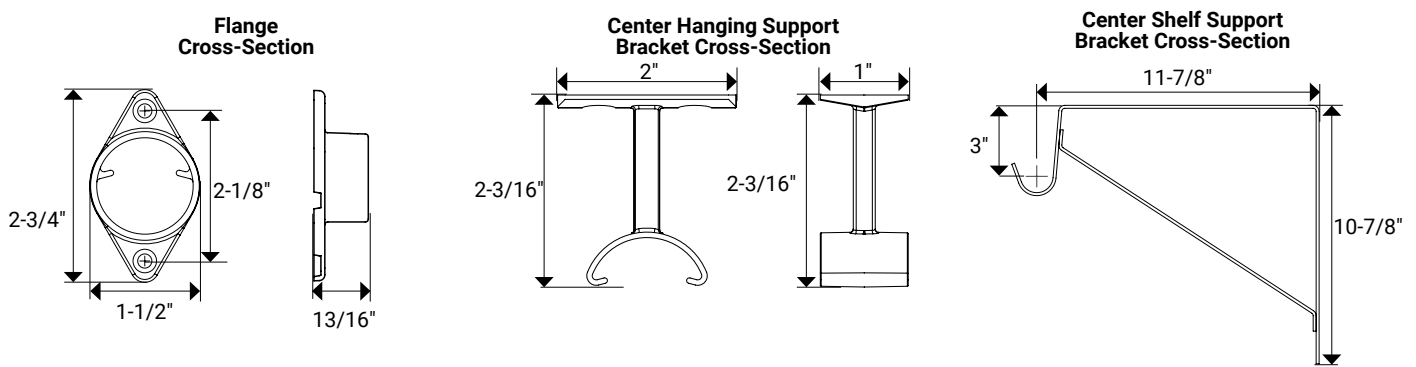

24-Volt Flexible Sheet Light Single-white Lighting

Easily enhance a design by adding flexible sheet lighting behind or underneath a countertop, backsplash, or decorative panel.

About the Product

- 400 diodes per sheet
- Each sheet is 12" x 18-1/2"
- Sheet can be cut every 3/4" on copper solder pads
- Heat dissipation leaves the sheet cool through extended use
- Dimmable (with compatible dimmer)
- Compatible with WAV Smart Control™ devices
- Bumper/spacers are recommended when installing under a surface (order separately)
- 24-volt DC plug-in or hardwired power supply required (order separately)
- 90+ CRI (Color Rendering Index)
- No Ultraviolet (UV) or Infrared (IR)
- 50,000 hour LED life at 70% lumen maintenance
- UL Listed

Applications

- Backsplashes, island panels
- Illuminate translucent countertops
- Architectural lighting
- Wherever flexible lighting is needed

Accessories

Find installation components starting on page 586

Kelvin Temperature Options



LED Specifications

LED Beam Angle: 120°

Lumen Output



Accessories

Part Number	Description	Dimensions
L-EZV2-6PK-BK	Black screw-down connectors with stability ramp; 6-pack; use to connect Flex Sheet to wire	3/4" x 7/16" x 5/16" (19 mm x 10 mm x 8 mm)
L-EZV2-6PK-WT	White screw-down connectors with stability ramp; 6-pack; use to connect Flex Sheet to wire	3/4" x 7/16" x 5/16" (19 mm x 10 mm x 8 mm)
L-EZL2L-6PK-WT	White screw-down connectors with stability ramp; 6-pack; use to connect Flex Sheet to Flex Sheet	15/16" x 3/8" x 5/16" (23 mm x 10 mm x 8 mm)
L-FSL-B-.56-CL	1/2" rubber bumper/spacer—Clear	.56" x .72" (14 mm x 18 mm)
L-FSL-B-.75-CL	3/4" rubber bumper/spacer—Clear	.75" x .75" (19 mm x 19 mm)



L-EZV2-WT



L-EZL2L-WT



L-FSL-B-.56-CL



24V 1600 Lumens/Sheet

Kelvin Temperature	Dimensions	Lumens Per Sheet	Watts Per Sheet	Cuttable Sections	Part Number
3000K, 4000K, 5000K	12" x 18-1/2" (300 mm x 470 mm)	1600	16	3/4" x 3/4" (19 mm x 19 mm)	L-FSL2-16W-Temp

Blue indicates dealer choice: Temp indicates Kelvin temperature. L-FSL2-16W-30 (Example part number for Flexible Sheet Light in 3000K Kelvin temperature)

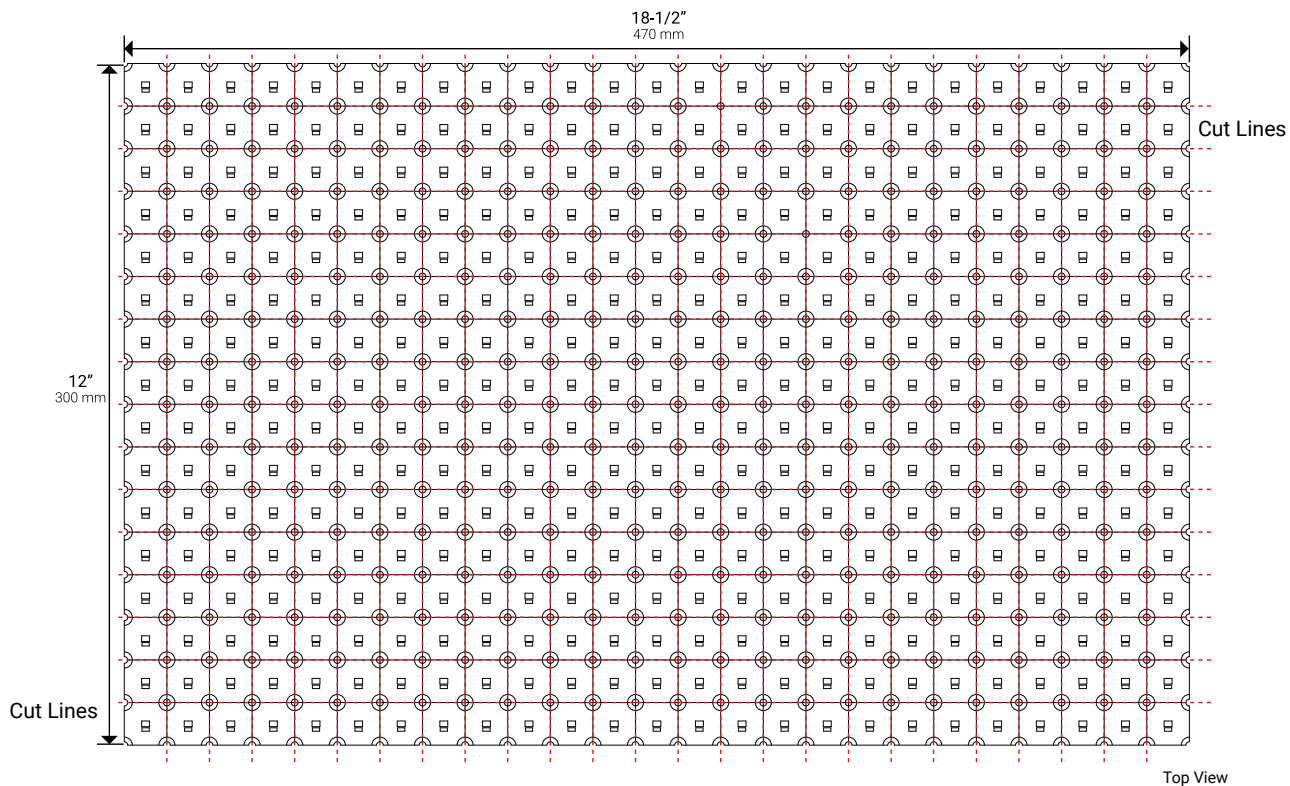



120-Volt LED Bar Light

Selectable white light

Ideal for a direct swap or upgrade from old halogen or fluorescent fixtures. Use above a sink or under a shelf to add bright light to any work space.

About the Product

- Toggle switch to change the white color temperature between 3 preset white temperatures NOTE: for full-range tunable-white lighting see our tunable-white lighting products
- Toggle switch to adjust brightness: off, medium, high
- Fully assembled fixture
- Dimmable when hardwired to a 120V circuit controlled by a compatible dimmer (order separately)
- Plug-in cord for easy installation (order separately)
- Butt connector included to link multiple fixtures for longer runs of unbroken lighting
- Linking cable to link multiple fixtures for longer runs of lighting fixtures (order separately)
- 90+ CRI (Color Rendering Index)
- No Ultraviolet (UV) or Infrared (IR)
- 50,000 hour LED life at 70% lumen maintenance
- ETL Listed

Applications

- Under cabinet
- Over sink
- Desk
- Workbench
- Garages and shops

Accessories

Find installation components starting on page 586

Available Finish Options



Selectable Kelvin Temperatures

NOTE: All options available on every fixture



Lumen Output



LED Specifications

LED Beam Angle: 120°

Accessories

Part Number	Description	Dimensions
L-BL-PC-05-B	Black 5 ft. 3-prong power cord	5 ft.
L-BL-PC-05-W	White 5 ft. 3-prong power cord	5 ft.
L-BL-LC-02-B	Black 2 ft. linking cable	2 ft.
L-BL-LC-02-W	White 2 ft. linking cable	2 ft.





120V 480 Lumens/Fixture

Fixture Length	Watts Per Fixture	Lumens Per Fixture	Part Number
9-1/2" (241 mm)	5	350	L-BL09-Color-TW
11-7/8" (302 mm)	7	480	L-BL12-Color-TW
17-7/8" (454 mm)	10	730	L-BL18-Color-TW
23-15/16" (608 mm)	12	950	L-BL24-Color-TW
31-15/16" (811 mm)	16	1300	L-BL32-Color-TW

Blue indicates dealer choice; Color indicates Finish Color.

L-BL12-BK-TW (Example part number for a 12" 120V Bar Light with Black finish)



18 in. dark silver fixture shown
L-BL18-DS-TW

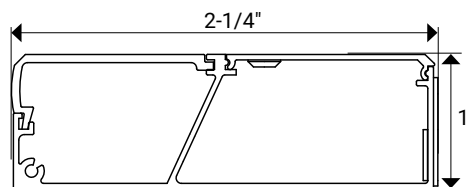

Fixture Cross-Section

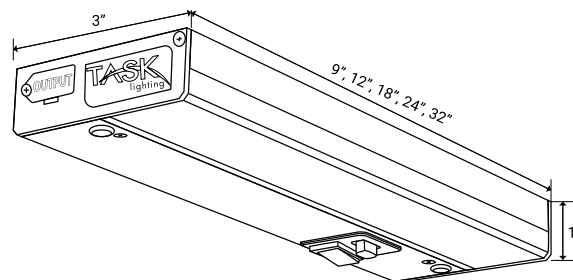

Soft White 3000K



Cool White 4000K



Daylight White 5000K



12-Volt LED Puck Lights Single-White and Tunable-White Lighting

Up- or down-lighting for cabinets, artwork, vases, or architecture. Surface mount or recess installation with versatile connection.

About the Products

- Recess or surface mount
- Fully assembled fixture with two lenses included: diamond (88°) and frosted (120°)
- For a recess mount option, a 2-1/2" hole saw is recommended
- Included 3 foot lead with barrel connector can be removed for direct wiring or daisy-chaining
- 12-volt DC plug-in or hardwired power supply required (order separately)
- Exceptional color rendering of 90+ CRI (Color Rendering Index)
- Dimmable (with compatible dimmer)
- No Ultraviolet (UV) or Infrared (IR)
- 50,000 hour LED life at 70% lumen maintenance
- UL Listed

Kelvin Temperature Options



Tunable-White Kelvin Temperatures

For tunable-white lighting puck light

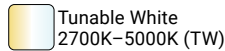

Housing Finish Options



Applications

- Interior cabinet
- Display/accent
- Closets
- Niche

Lumen Output



Accessories

Find installation components starting on page 586





12V 190 Lumens/Fixture

Kelvin Temperature	Lumens Per Fixture	Watts Per Fixture	Part Number
Tunable-white 2700K–5000K	190	2.4	L-TWSP-FR-Color

Blue indicates dealer choice: Finish indicates Finish Color. Temp indicates Kelvin Temperature.
 L-TWSP-FR-WT (Example part number for Tunable-White Puck Light with White finish)

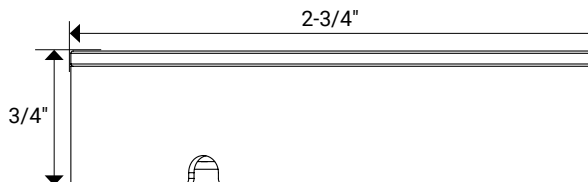

Fixture Cross-Section



12V 180 Lumens/Fixture

Kelvin Temperature	Lumens Per Fixture	Watts Per Fixture	Part Number
3000K, 4000K	180	3	L-SWSP-FR-Color-Temp

Blue indicates dealer choice: Finish indicates Finish Color. Temp indicates Kelvin Temperature.
 L-SWSP-FR-BK-30 (Example part number for Single-White Puck Light with Black finish in 3000K)

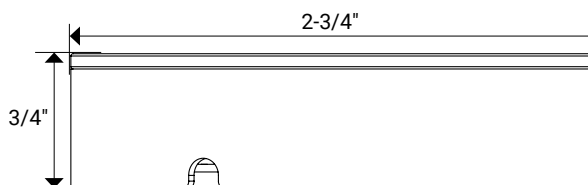

Fixture Cross-Section



LED Lighting Accessories

Easily install and control lighting

A variety of connectors, power supplies, and lighting control options make Task Lighting & Power products easy to install and control lighting in various applications.



Selecting the Proper Power Supply

A power supply works to convert power from the wall or main electrical source down to a level that can work with the low voltage light source at hand, often 12-volt or 24-volt. When planning your project, consider how the wall power is set up. Most installations fall into one of 3 categories: outlet, junction box, or wall switch/dimmer. Follow the next page to see which power supply is best for your project.

Plug-in Power Supply using an outlet (dimming on low voltage side)

Best used for an easy plug-and-play installation; no electrician required. Compatible with wireless dimming system, switches, and sensors. Use with tunable-white, single-white, and multi-color RGB lighting systems.

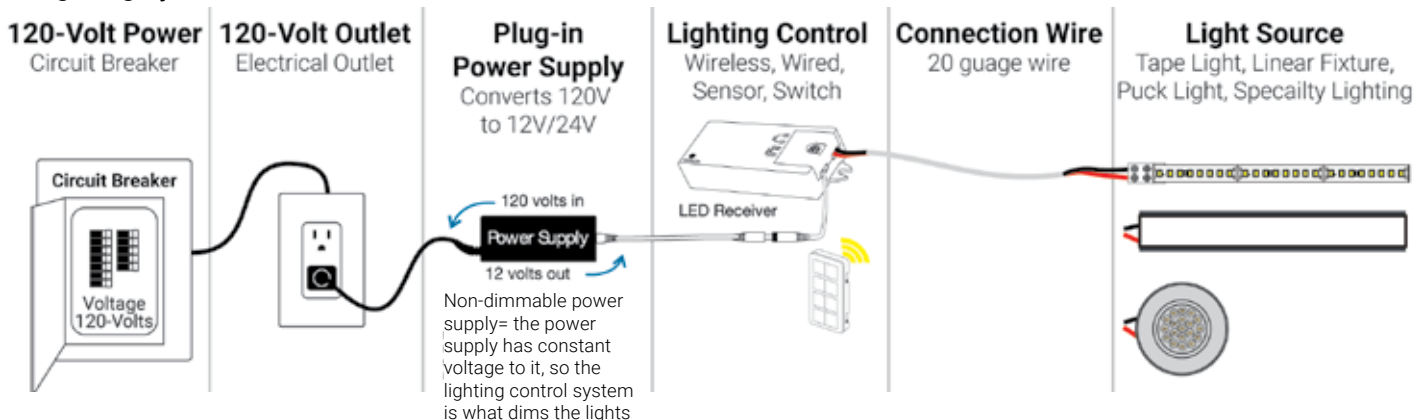

Hardwired Waterproof Power Supply using a junction box

(dimming on low voltage side)

Best used for a hardwired power supply to use with wireless dimming system. Compatible with wireless dimming system, switches, and sensors. Use with tunable-white, single-white, and multi-color RGB lighting systems.

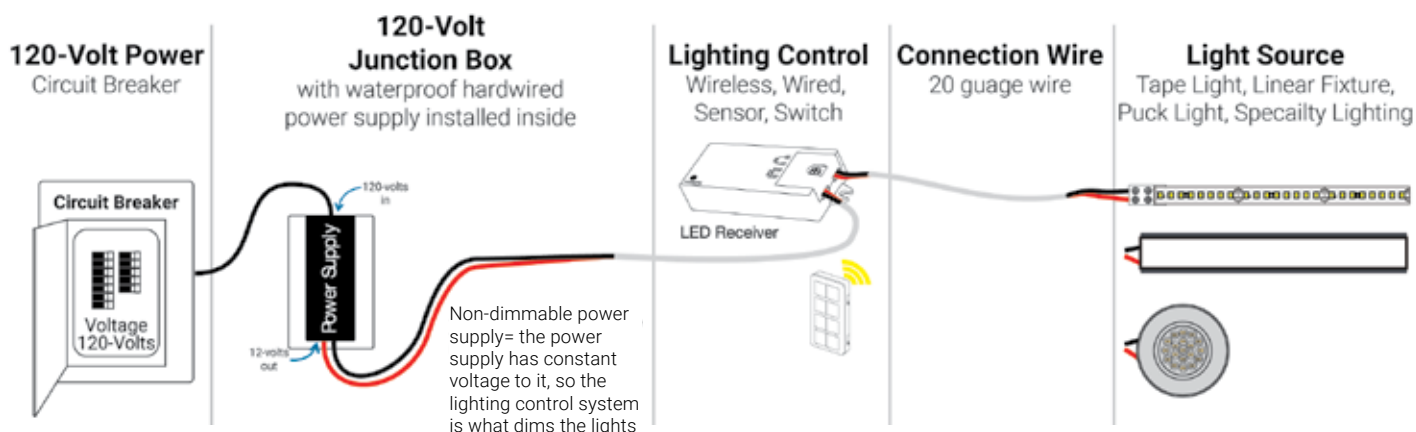

Hardwired Power Supply using a wall switch

(dimming on line voltage side)

Dimmable on 120V input side. Best for pairing with a wall switch/dimmer. Electrician recommended for installation. Compatible with wall switch/dimmer. Use with single-white lighting systems.

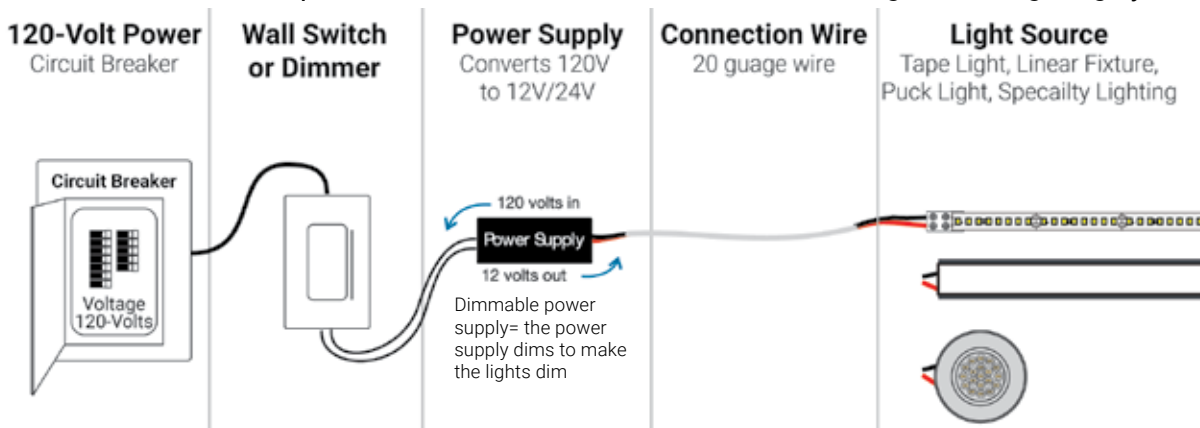

Determining the load size for power supplies

After selecting the type of power supply, determine the load size in total watts using the calculations below. Then select a power supply greater than that wattage requirement.

Load size (tape lighting) = total watts per foot X total combined feet

Load size (linear fixture/puck lights) = total watts per fixture X total number of fixtures

Example for figuring out load size:

1.5 watts per foot X 12 feet = 18 watts (recommended 24-watt power supply for this project)



Lighting Control Systems

Control single-white, tunable-white, or multi-color lighting with a wide variety of controls: wireless dimming system, smart home control, sensors and switches, or wall mount switch/dimmer.

Wireless Dimming System

Wireless Dimming System

Best used where flexibility and convenience are needed without the worry of wiring a switch. Use to control one, two, or four zones of lighting to easily personalize lighting to any time of the day or event.

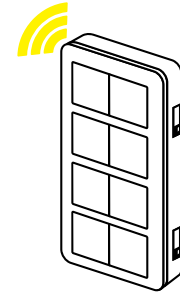

Smart Home Control

Smart Home Control

Conveniently manage lighting by connecting to a smart home hub. It's easy to enhance daily routines by easily creating personalized white lighting temperatures or multi-color lighting and the brightness throughout the day.

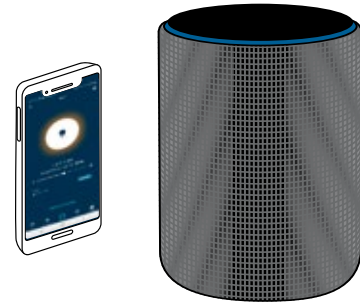

Sensors and Switches

Sensors and Switches

Install a sensor when lighting inside a cabinet to click the lights on or off when the cabinet door opens, or use under a bathroom vanity to control the lighting and not worry about turning lights on or off. There are a variety of sensors and switches available including proximity sensors, touch sensors, motion sensors, and more.

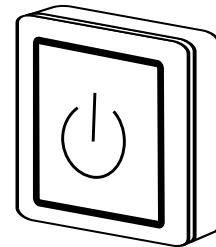

Wall Mount Switch/Dimmer

Wall Mount Switch/Dimmer

Use a wall switch when installing a hardwired power supply as a simple way to turn lights on, off, or dim. Be sure to check the hardwired power supply for compatibility with wired wall dimmers when dimming.

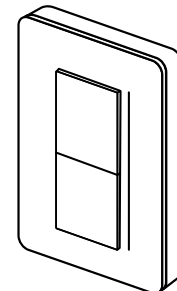



WAV Smart Control™



Wireless ● App ● Voice
SMART CONTROL

How does WAV work?

WAV stands for Wireless-App-Voice and is a smart device that turns LED Lighting products into smart home connected lights using Zigbee 3.0 technology.

Control lights with Amazon Alexa, Google Home, Philips Hue, Apple HomeKit, or any Zigbee 3.0 compatible system.

Control with a Wireless Controller

Easy tuning with a Wireless Controller

Use one of our Wireless Controllers designed to turn single-white LED lights on/off or dim. Use the Tunable-White Wireless Controller to turn the lights on/off, dim, and tune the white color temperature for tunable-white lighting.

Also requires a WAV Smart Receiver (T-TWAV-WR-120) or WAV Smart Receiver/Power Supply (T-TWAV-60W-PSR)

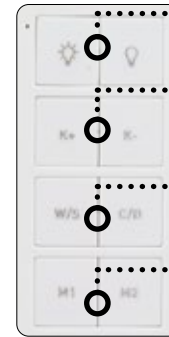

Tunable-White Wireless Controller
T-T-1Z-WC-RF-WT

- Turn on/off or dim lighting
- Tune from Warm White 2700K up to Daylight White 5000K
- Preset color temperatures of Warm White 2700K
- Soft White 3000K
- Cool White 4000K
- Daylight White 5000K
- Program to always return to your favorite tuned white color temperature

Control with a Smart home app

Customize your lighting with an app

Use the smart home device's app to turn the LED lights on/off and dim. If using the tunable-white lights, tune the white light color temperature. Use the app to set up a schedule to tune color and/or brightness of the lights throughout the day!

Also requires a WAV Smart Receiver (T-TWAV-WR-120) or WAV Smart Receiver/Power Supply (T-TWAV-60W-PSR)



Samsung SmartThings app shown in use

(Use the app from the selected smart home device of choice. No need to download a separate app)

Control with voice using a Smart home hub

Go hands-free with voice control

Use voice control with the smart home device to turn the LED lights on/off and dim. If using the tunable-white lights, tune the white light color temperature.

Also requires a WAV Smart Receiver (T-TWAV-WR-120) or WAV Smart Receiver/Power Supply (T-TWAV-60W-PSR)



"Alexa, set the kitchen to Warm White"

(Smart home device not sold by Task Lighting)

Find more online

Scan the QR code to see a list of compatible smart home devices and how to incorporate WAV Smart Control™ in any project.



Scan the QR code to view a list of compatible smart home devices

WAV Smart Control™ products work with Zigbee-enabled smart home hub products available from several manufacturers.



Zigbee is a trademark of Zigbee Alliance, Davis, California. Alexa is a trademark of Amazon, Seattle, Washington. Google Home is a trademark of Googleplex, Mountain View, California. HomeKit is a trademark of Apple, Cupertino, California. These marks are not affiliated with nor approved endorsements of Task Lighting & Power.

12-Volt WAV Smart Receiver/Plug-in Power Supply

Compatible with the wireless dimming system and smart home hubs (smart home device not included).

Part Number	Description	Dimensions
T-TWAV-60W-PSR	60-watt, 12-volt WAV Smart Receiver/Plug-in Power Supply. Option to wire as a hardwired power supply.	7-5/16" x 2-1/8" x 1-1/4" (187 mm x 73 mm x 32 mm)



T-TWAV-60W-PSR

12-Volt Plug-in Power Supplies

Compatible with the wireless dimming system, switches, and sensors.

Part Number	Description	Dimensions
T-12W-12V-PI	12-watt AC/DC, 2 prong plug-in, 12-volt DC 1-amp.	1-15/16" x 1-1/8" x 2-15/16" (50 mm x 29 mm x 74 mm)
T-24W-12V-PI	24-watt AC/DC, 2 prong plug-in, 12-volt DC 2-amp.	3-5/8" x 1-13/16" x 1-5/8" (92 mm x 46 mm x 41 mm)
T-36W-12V-PI	36-watt AC/DC, 2 prong plug-in, 12-volt DC 3-amp.	3-11/16" x 1-15/16" x 1-9/16" (94 mm x 50 mm x 40 mm)
T-60W-12V-PI	60-watt AC/DC, 2 prong plug-in, 12-volt DC 5-amp.	5-1/16" x 2" x 1-5/16" (129 mm x 52 mm x 33 mm)
T-96W-12V-PI	96-watt AC/DC, 3 prong plug-in, 12-volt DC 8-amp.	5-9/16" x 2-3/8" x 1-3/8" (141 mm x 61 mm x 35 mm)
T-120W-12V-PI	120-watt AC/DC, 3 prong plug-in, 12-volt DC 10-amp.	6-5/16" x 2-11/16" x 1-1/4" (161 mm x 69 mm x 33 mm)



T-24W-12V-PI



T-60W-12V-PI

12-Volt Waterproof Power Supplies

Compatible with the wireless dimming system, switches, and sensors.

Part Number	Description	Dimensions
T-60W-12-WP-HW	60-watt, 12-volt IP67-rated waterproof hardwired.	6-1/2" x 1-5/8" x 1-1/4" (165 mm x 41 mm x 32 mm)
T-150W-12-WP-HW	150-watt, 12-volt IP67-rated waterproof hardwired.	7-3/8" x 2-3/8" x 1-1/2" (188 mm x 60 mm x 39 mm)



T-60-12-WP-HW

12-Volt Hardwired Power Supplies

Compatible with a wall switch or dimmer.

Part Number	Description	Dimensions
T-DT24W-12V-HW	12-watt, 12-volt DC dimmable class 2 hardwired.	13-13/16" x 3" x 1-1/2" (350 mm x 77 mm x 37 mm)
T-DT48W-12V-HW	48-watt, 12-volt DC dimmable class 2 hardwired.	13-13/16" x 3" x 1-1/2" (350 mm x 77 mm x 37 mm)
T-DT60W-12V-HW	60-watt, 12-volt DC dimmable class 2 hardwired.	13-13/16" x 3" x 1-1/2" (350 mm x 77 mm x 37 mm)
T-DT120W-12V-HW	120-watt, 12-volt DC dimmable class 2 hardwired.	15" x 3" x 2-1/4" (381 mm x 77 mm x 57 mm)



T-DT60W-12V-HW

12-Volt Industrial Power Supply

Compatible with a switch or with the low voltage dimming systems.

Part Number	Description	Dimensions
T-350W-12V-HW	350-watt, 12-volt indoor industrial hardwired.	8-1/2" x 4-1/2" x 1-1/4" (216 mm x 102 mm x 32 mm)



T-350W-12V-HW

24-Volt Power Supply with Built-in Wireless Receiver

Compatible with the wireless dimming system.

Part Number	Description	Dimensions
T-DQ75W-24V-HW	75-watt, 24-volt DC RF CV hardwired with built-in wireless receiver. Hardwired or install with a power cord.	8-1/2" x 4-1/2" x 1-1/4" (216 mm x 102 mm x 32 mm)



T-DQ75W-24V-HW

24-Volt WAV Smart Receiver/Plug-in Power Supply

Compatible with the wireless dimming system and smart home hubs (smart home device not included).

Part Number	Description	Dimensions
T-TWAV24V96WPSR	96-watt, 24-volt WAV Smart Receiver/Plug-in Power Supply. Option to wire as a hardwired power supply.	7-5/16" x 2-1/8" x 1-1/4" (187 mm x 73 mm x 32 mm)



T-TWAV24V96WPSR

24-Volt Plug-in Power Supplies

Compatible with the wireless dimming system, switches, and sensors.

Part Number	Description	Dimensions
T-24V-24W-PI	24-watt AC/DC, 2 prong plug-in, 24-volt DC 1-amp.	3-1/8" x 1-3/4" x 1-3/16" (79 mm x 44 mm x 31 mm)
T-24V-60W-PI	60-watt AC/DC, 2 prong plug-in, 24-volt DC 2.5-amp.	4-3/8" x 1-15/16" x 1-3/16" (111 mm x 49 mm x 31 mm)
T-24V-96W-PI	96-watt AC/DC, 3 prong plug-in, 24-volt DC 4-amp.	5" x 2-1/4" x 1-1/4" (130 mm x 58 mm x 31 mm)
T-24V-120W-PI	120-watt AC/DC, 3 prong plug-in, 24-volt DC 5-amp.	6-5/16" x 2-11/16" x 1-1/4" (161 mm x 68 mm x 31 mm)



T-24V-24W-PI



T-24V-120W-PI

24-Volt Waterproof Power Supplies

Compatible with the wireless dimming system, switches, and sensors.

Part Number	Description	Dimensions
T-24-60W-WP-HW	60-watt, 24-volt IP67-rated waterproof hardwired.	6-1/2" x 1-5/8" x 1-1/4" (165 mm x 41 mm x 32 mm)
T-24-96W-WP-HW	96-watt, 24-volt IP67-rated waterproof hardwired.	6-1/2" x 1-5/8" x 1-1/4" (165 mm x 41 mm x 32 mm)
T-24-150W-WP-HW	150-watt, 24-volt IP67-rated waterproof hardwired.	7-3/8" x 2-3/8" x 1-1/2" (188 mm x 60 mm x 39 mm)



T-24-60W-WP-HW

24-Volt Hardwired Power Supplies

Compatible with a wall switch or dimmer.

Part Number	Description	Dimensions
T-24V-DT30W-HW	30-watt, 24-volt DC dimmable class 2 hardwired.	13-13/16" x 3" x 1-1/2" (350 mm x 77 mm x 37 mm)
T-24V-DT60W-HW	60-watt, 24-volt DC dimmable class 2 hardwired.	13-13/16" x 3" x 1-1/2" (350 mm x 77 mm x 37 mm)
T-24V-DT120W-HW	120-watt, 24-volt DC dimmable hardwired.	15" x 3" x 2-1/4" (380 mm x 77 mm x 57 mm)



T-24V-DT60W-HW

24-Volt Industrial Power Supply

Compatible with a switch or with the low voltage dimming systems.

Part Number	Description	Dimensions
T-350W-24V-HW	350-watt, 24-volt indoor industrial hardwired.	8-1/2" x 4-1/2" x 1-1/4" (216 mm x 102 mm x 32 mm)



T-350W-24V-HW

Receivers for Wireless Dimming System

Use with plug-in, hardwired waterproof, and the WAV Smart Receiver/Power Supply.

Part Number	Description	Dimensions
T-Q-WR96	96-watt receiver for single-white lighting. Use one receiver per zone and pair with a wireless controller.	3-7/8" x 1-7/16" x 13/16" (95 mm x 37 mm x 20 mm)
T-Q-WR240	240-watt receiver for single-white lighting. Use one receiver per zone and pair with a wireless controller.	7" x 1-13/16" x 7/8" (178 mm x 46 mm x 20 mm)
T-TWAV-WR-120	120-watt WAV Smart receiver for single-white and tunable-white lighting. Use one receiver per zone and pair with a wireless controller. Smart home hub sold separately.	4-1/4" x 2-1/4" x 3/8" (108 mm x 57 mm x 22 mm)
T-C-RGB180	180-watt receiver for multi-color RGB lighting. Use one receiver per zone and pair with a wireless controller.	7" x 1-13/16" x 7/8" (178 mm x 46 mm x 22 mm)
T-WAV-WR180-RGB	180-watt WAV Smart receiver for RGB lighting. Use one receiver per zone and pair with a wireless controller. Smart home hub sold separately.	4-1/4" x 2-1/4" x 3/8" (108 mm x 57 mm x 22 mm)



96W Receiver
T-Q-WR96



WAV Smart Receiver
T-TWAV-WR-120

Wireless Controllers

Use with Linear Fixtures, Tape Lighting, Puck Lights, Lighted Power Strip Single-White and Tunable-White RM Series

Part Number	Description	Dimensions
T-T-1Z-WC-RF-WT	White Tunable-White wireless controller. Controls one zone of lights with on/off, dimming, tune the white light, and program into memory.	2-5/8" x 1-5/16" x 3/8" (67 mm x 33 mm x 10 mm)
T-C-RGBWC-RF-WT	White RGB wireless controller. Controls one zone of lights with on/off, dimming, multi-color changing options, and program into memory.	2-5/8" x 1-5/16" x 3/8" (67 mm x 33 mm x 10 mm)
T-Q-1Z-WC-RF-WT	White One-Zone wireless controller. Controls one zone of lights with on/off and dimming options.	2-5/8" x 1-5/16" x 3/8" (67 mm x 33 mm x 10 mm)
T-Q-2Z-WC-RF-WT	White Two-Zone wireless controller. Controls two zones of lights with on/off and dimming options.	2-5/8" x 1-5/16" x 3/8" (67 mm x 33 mm x 10 mm)
T-Q-4Z-WC-RF-WT	White Four-Zone wireless controller. Controls four zones of lights with on/off and dimming options.	2-5/8" x 1-5/16" x 3/8" (67 mm x 33 mm x 10 mm)



Tunable-White Controller
T-T-1Z-WC-RF-WT



Four-Zone Controller
T-Q-4Z-WC-RF-WT

Cover Plates for Wireless Controllers

Use to mount wireless controllers neatly to the wall

Part Number	Description	Dimensions
T-DPL-Color	Decora style cover plate to fit over wireless controller on wall. Available in Almond (AL), Black (BK), Brown (BR), Grey (GR), or White (WT).	4-11/16" x 2-15/16" x 11/16" (119 mm x 75 mm x 17 mm)



Decora Cover Plate
T-DPL-GR

Round Switch

Use with Linear Fixtures, Tape Lighting, Puck Lights, Lighted Power Strip Single-White RM Series

Part Number	Description	Dimensions
T-RS-BK	On/off round rocker switch designed to be recess mounted.	15/16" diameter



T-RS-BK

Magnetic Low Voltage Dimmer

Use with hardwired power supplies

Part Number	Description	Dimensions
DVLV-600P-Color	600-watt Diva slide dimmer. Use with hardwired power supplies. Available in Almond (AL), Black (BK), Grey (GR), or White (WT).	4-11/16" x 2-15/16" x 11/16" (119 mm x 75 mm x 17 mm)



DVLV-600P-WT

Electronic Low Voltage Dimmer

Use with Lighted Power Strip Single-White DV Series

Part Number	Description	Dimensions
DVELV-300P-Color	300-watt Diva slide dimmer. Use with the Lighted Power Strip DV Series. Available in Almond (AL), Black (BK), Grey (GR), or White (WT).	8-1/2" x 4-1/2" x 1-1/4" (216 mm x 102 mm x 32 mm)



DVELV-300P-WT

Tunable-White Wired Controller

Use with Tunable-White Tape Lighting, Linear Fixtures, Lighted Power Strip, and Puck Light

Part Number	Description	Dimensions
T-TIL-96	96-watt wired controller. Controls one zone of lights with on/off, dimming, tune the white light, and optional wave sensor for on/off control.	3-9/16" x 1-9/16" x 7/8" (91 mm x 40 mm x 22 mm)



T-TIL-96

Switches and Sensors

Use with Linear Fixtures, Tape Lighting, Puck Lights, Lighted Power Strip Single-White and Tunable-White RM Series

Part Number	Description	Dimensions
T-DSS-30W-IR	Infrared (IR) door sensor switch. The surface mount IR door sensor switch, with a 1-1/2" detection area, allows lights to remain on until the door or drawer is closed.	3/8" x 1" x 1-1/4" (10 mm x 25 mm x 312 mm)
T-2HDSS-30W-IR	Infrared (IR) door sensor switch with two heads for use in two-door cabinet. The surface mount IR door sensor switch, with a 1-1/2" detection area, allows lights to remain on until the door or drawer is closed.	3/8" x 1" x 1-1/4" (10 mm x 25 mm x 32 mm)
T-MSS-60W	Motion sensor switch. The motion sensor activates the lighting and shuts it off 30 seconds after no motion is detected within 120° of the eye of the sensor within 10 ft.	1/2" x 2-1/4" (13 mm x 57 mm)
T-MSS-D-TS	Doppler motion sensor switch. The motion sensor activates the lighting and shuts it off after 1, 2, 3, or 4 minutes after no motion is detected from any direction within 15 ft. NOTE: Can detect movement through a non-metal barrier 2" or less.	3-7/8" x 1-13/16" x 13/16" (95 mm x 37 mm x 20 mm)
T-PSS-60W-IR	Infrared (IR) sensor proximity switch. Ideal for drawer lighting, as its thin profile allows it to be placed at the back of the drawer to detect when closed.	2-1/4" x 3/8" (57 mm x 10 mm)
T-TDS-60W	LED touch dimmer. Touch to switch lights on/off and hold to dim.	3/8" x 2" x 2" (10 mm x 51 mm x 51 mm)
T-TDS-R	Recessed LED touch dimmer. Touch to switch lights on/off and hold to dim.	2-1/4" x 29/64" (57 mm x 12 mm)
T-WSS-60W-IR	Infrared (IR) wave sensor switch. Install near the light source and activate by waving hand in front of IR sensor to turn on/off.	2-1/4" x 3/8" (57 mm x 10 mm)



Door Sensor
T-DSS-30W-IR



Doppler Motion Sensor
T-MSS-D-TS



Touch Dimmer
T-TDS-60W



Proximity Sensor
T-PSS-60W-IR

Amplifier

Use with RGB and single-white lighting

Part Number	Description	Dimensions
T-AMP-180W	Use when powering more than 32 ft. of RGB or single-white lighting. Repeats signal, eliminating the need for added receivers.	7" x 1-13/16" x 7/8" (178 mm x 46 mm x 22 mm)



T-AMP-180W

EZ Screw-Down Connectors

Use with LED Lighting

Part Number	Description	Dimensions
L-EZV2-6PK-BK	Black screw-down connectors with stability ramp; 6-pack; use to connect 8 mm or 10 mm tape light to stripped wire	3/4" x 7/16" x 5/16" (19 mm x 10 mm x 8 mm)
L-EZV2-100PK-BK	Black screw-down connectors with stability ramp; 100-pack; use to connect 8 mm or 10 mm tape light to stripped wire	3/4" x 7/16" x 5/16" (19 mm x 10 mm x 8 mm)
L-EZV2-6PK-WT	White screw-down connectors with stability ramp; 6-pack; use to connect 8 mm or 10 mm tape light to stripped wire	3/4" x 7/16" x 5/16" (19 mm x 10 mm x 8 mm)
L-EZV2-100PK-WT	White screw-down connectors with stability ramp; 100-pack; use to connect 8 mm or 10 mm tape light stripped to wire	3/4" x 7/16" x 5/16" (19 mm x 10 mm x 8 mm)



L-EZV2-WT

Light-to-Light EZ Screw-Down Connectors

Use with LED Lighting

Part Number	Description	Dimensions
L-EZL2L-6PK-WT	White screw-down connectors with stability ramp; 6-pack; use to connect 8 mm or 10 mm tape light to tape light or Flex Sheet to Flex Sheet	15/16" x 3/8" x 5/16" (23 mm x 10 mm x 8 mm)



L-EZL2L-WT

Flex EZ Screw-Down Connectors

Use with LED Lighting

Part Number	Description	Dimensions
L-EV2-FLX3PK-W	White corner connectors with 4" wire between connectors; 3-pack; use with single-white and tunable-white lighting	5" x 3/8" x 5/16" (130 mm x 10 mm x 8 mm)



RGB Snap Connectors

Use with LED Lighting

Part Number	Description	Dimensions
L-10MM-RGB-WTT	Clear snap connector used to connect 4-wire RGB to RGB tape light. Sold individually. NOTE: Do not strip wire.	7/8" x 5/8" x 5/16" (22 mm x 15 mm x 7 mm)
L-10MM-RGB-TTTC	Clear snap connector used to connect RGB tape light to RGB tape light. Sold individually.	3/4" x 5/8" x 5/16" (19 mm x 15 mm x 7 mm)



Barrel Connectors

Use with LED Lighting

Part Number	Description	Dimensions
T-FBC	Female barrel to screw-down connector.	1-9/16" x 9/16" x 1/2" (40 mm x 15 mm x 13 mm)
T-MBC	Male barrel to screw-down connector.	1-9/16" x 9/16" x 1/2" (40 mm x 15 mm x 13 mm)



Plug Connectors

Use with LED Lighting

Part Number	Description	Dimensions
T-FPC	Female plug connector.	6-1/2" overall length (165 mm)
T-MPC	Male plug connector.	6-1/2" overall length (165 mm)

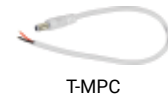

Mini Junction Wire Box

Use with LED Lighting

Part Number	Description	Dimensions
T-JB-W	Mini wire junction box with plastic housing. NOTE: Low voltage connections only, do not use with 120-volt connections.	2" x 1" x 11/16" (51 mm x 24 mm x 16 mm)



9-amp Wire Distribution Block

Use with LED Lighting

Part Number	Description	Dimensions
T-WDB-W	White 9-amp wire distribution block with a single input terminal set and 6 output terminals sets. Use with 12-volt and 24-volt single-white and tunable-white lighting products.	15/16" x 2-5/16" x 3/8" (23 mm x 58 mm x 9 mm)



3-Way Splitter

Use with LED Lighting

Part Number	Description	Dimensions
T-3WSP	DC 3-way splitter plug. Use to connect multiple LED light fixtures to power.	16" overall length (406 mm) 8" length/splice (203 mm)



In-line Pin Connector

Use with LED Linear Fixtures

Part Number	Description	Dimensions
STS-ICONN	In-line pin connector for direct connection of adjacent fixtures—use with LED Linear Fixtures. Sold in pairs.	1/2" x 1/32" (13 mm x 1 mm)



Push Connector

Use with LED Linear Fixtures

Part Number	Description	Dimensions
T-EZWC	EZ wire-to-wire connector. Must strip wire to insert into connector	13/16" x 11/16" x 5/16" (20 mm x 18 mm x 8 mm)



120-Volt Bar Light Cord and Cable

Use with 120-Volt LED Bar Light

Part Number	Description	Dimensions
L-BL-PC-05-B	5 ft. 3-prong power cord; black	5 ft. (1.5 m)
L-BL-PC-05-W	5 ft. 3-prong power cord; white	5 ft. (1.5 m)
L-BL-LC-02-B	2 ft. linking cable; black	2 ft. (610 mm)
L-BL-LC-02-W	2 ft. linking cable; white	2 ft. (610 mm)



L-BL-PC-05-W



L-BL-LC-02-W

Stranded Wire

Use with Linear Fixtures, Tape Lighting, Puck Lights, Lighted Power Strip Single-White and Tunable-White RM Series

Part Number	Description	Dimensions
T-CW20G-STR-25	25 ft. spool of 20/2 AWG stranded wire	1/8" (3 mm)
T-CW20G-STR-50	50 ft. spool of 20/2 AWG stranded wire	1/8" (3 mm)
T-CW20G-STR-100	100 ft. spool of 20/2 AWG stranded wire	1/8" (3 mm)
T-CW20G-STR-500	500 ft. spool of 20/2 AWG stranded wire	1/8" (3 mm)
T-CW20G-STR-1K	1,000 ft. spool of 20/2 AWG stranded wire	1/8" (3 mm)
T-CW20G-STR-1	20/2 AWG stranded wire. Specify the number of feet needed when ordering. Sold per foot. Must order a minimum of 2 ft.	1/8" (3 mm)



T-CW20G-STR-25

Solid Wire

Use with Linear Fixtures, Tape Lighting, Puck Lights, Lighted Power Strip Single-White and Tunable-White RM Series

Part Number	Description	Dimensions
T-CW20G-SOL-25	25 ft. spool of 20/2 AWG solid wire	1/8" (3 mm)
T-CW20G-SOL-50	50 ft. spool of 20/2 AWG solid wire	1/8" (3 mm)
T-CW20G-SOL-100	100 ft. spool of 20/2 AWG solid wire	1/8" (3 mm)
T-CW20G-SOL-500	500 ft. spool of 20/2 AWG solid wire	1/8" (3 mm)
T-CW20G-SOL-1K	1,000 ft. spool of 20/2 AWG solid wire	1/8" (3 mm)
T-CW20G-SOL-1	20/2 AWG solid wire. Specify the number of feet needed when ordering. Sold per foot. Must order a minimum of 2 ft.	1/8" (3 mm)



T-CW20G-SOL-25

RGB Stranded Wire

Use with Multi-Color RGB

Part Number	Description	Dimensions
L-RGB-4C-WIRE	22 gauge double sleeve construction wire for 4-wire RGB. Sold per foot. Must order a minimum of 2 feet.	5/32" outside diameter (4 mm)



Flex Sheet Light Accessories

Use with 24-volt Flexible Sheet Light

Part Number	Description	Dimensions
L-FSL-B-.56-CL	.56" rubber bumper/spacer; clear	1/2" x 3/4" (14 mm x 18 mm)
L-FSL-B-.75-CL	.75" rubber bumper/spacer; clear	3/4" x 3/4" (19 mm x 19 mm)



L-FSL-B-.56-CL

Aluminum Profiles

Use with LED Tape Lighting

Part Number	Description	Dimensions
L-PFAP-FR-48	48" field-cuttable Premium Flat aluminum profile, frosted lens, plastic colored mount. Available in Black (BK), or White (WT). Compatible with 8 mm and 10 mm LED tape lighting. Use with L-PFEC for end caps.	48" x 7/8" x 9/16" (1219 mm x 23 mm x 14 mm)
L-PFAP-FR-90	90" field-cuttable Premium Flat aluminum profile, frosted lens, plastic colored mount. Available in Black (BK), or White (WT). Compatible with 8 mm and 10 mm LED tape lighting. Use with L-PFEC for end caps.	90" x 7/8" x 9/16" (2286 mm x 23 mm x 14 mm)
L-DM-FR-48	48" field-cuttable Dual-Mount aluminum profile, frosted lens. Compatible with 8 mm and 10 mm LED tape lighting. Use with L-EC-DM for end caps and L-MC-007 for mounting clips.	48" x 5/8" x 1/2" (1219 mm x 16 mm x 12 mm)
L-DM-FR-90	90" field-cuttable Dual-Mount aluminum profile, frosted lens. Compatible with 8 mm and 10 mm LED tape lighting. Use with L-EC-DM for end cap and L-MC-007 for mounting clips.	90" x 5/8" x 1/2" (2286 mm x 16 mm x 12 mm)
L-002-FR-48	48" field-cuttable 002 recessed aluminum profile with frosted lens. Compatible with 8 mm and 10 mm LED tape lighting. Use with L-EC-002 for end caps.	48" x 1" x 5/16" (1219 mm x 25 mm x 8 mm)
L-002-FR-90	90" field-cuttable 002 recessed aluminum profile with frosted lens. Compatible with 8 mm and 10 mm LED tape lighting. Use with L-EC-002 for end caps.	90" x 1" x 5/16" (2286 mm x 25 mm x 8 mm)
L-002XL-FR-48	48" field-cuttable 002 XL Series recessed aluminum profile, frosted lens. Compatible with 8 mm and 10 mm LED tape lighting. Use with L-EC-002 for end caps.	48" x 1" x 5/16" (1219 mm x 25 mm x 8 mm)
L-002XL-FR-90	90" field-cuttable 002 XL Series recessed aluminum profile, Frosted lens. Compatible with 8 mm and 10 mm LED tape lighting. Use with L-EC-002 for end caps.	90" x 1" x 5/16" (2286 mm x 25 mm x 8 mm)
L-003-FR-48	48" field-cuttable 003 angled aluminum profile with frosted lens. Compatible with 8 mm and 10 mm LED tape lighting. Use with L-EC-003 for end caps and L-MC-003 for mounting clips.	48" x 5/8" x 5/8" (1219 mm x 16 mm x 16 mm)
L-003-FR-90	90" field-cuttable 003 angled aluminum profile with frosted lens. Compatible with 8mm and 10mm LED tape lighting. Use with L-EC-003 for end caps and L-MC-003 for mounting clips.	90" x 5/8" x 5/8" (2286 mm x 16 mm x 16 mm)
L-007-FR-48	48" field-cuttable 007 flat aluminum profile with frosted lens. Compatible with 8 mm and 10 mm LED tape lighting. Use with L-8MM-EZ6PK for end caps and L-MC-007 for mounting clips.	48" x 5/8" x 3/8" (1219 mm x 16 mm x 10 mm)
L-007-FR-90	90" field-cuttable 007 flat aluminum profile with frosted lens. Compatible with 8 mm and 10 mm LED tape lighting. Use with L-8MM-EZ6PK for end caps and L-MC-007 for mounting clips.	90" x 5/8" x 3/8" (2286 mm x 16 mm x 10 mm)
L-LCR-FR48-Finish	48" field-cuttable Lighted Closet Rod profile with frosted lens. Available in Black (BK), Satin Nickel (SN), or White (WT).	48" x 1-5/16" x 1-1/8" (1219 mm x 33 mm x 29 mm)
L-LCR-FR90-Finish	90" field-cuttable Lighted Closet Rod profile with frosted lens. Available in Black (BK), Satin Nickel (SN), or White (WT).	90" x 1-5/16" x 1-1/8" (2286 mm x 33 mm x 29 mm)



L-PFAP



L-PDM

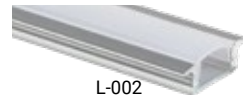

L-002



L-002XL-FR-90



L-003



L-007



L-OLC-FR-90-P-SN

Plastic Wire Managers

Use for hiding wires leading to LED Lighting

Part Number	Description	Dimensions
L-PFWW-Color-48	48" Plastic WireWay used to conceal wire for L-PFAP premium fixture aluminum profile. Available in Black (BK) or White (WT).	48" x 7/8" x 9/16" (1219 mm x 23 mm x 14 mm)
L-PFWW-Color-90	90" Plastic WireWay used to conceal wire for L-PFAP premium fixture aluminum profile. Available in Black (BK) or White (WT).	90" x 7/8" x 9/16" (2286 mm x 23 mm x 14 mm)
L-PFMJ-Color-12	(2) 12" WireWay pieces with 45° miter joint for L-PFAP premium flat linear fixture. Available in Black (BK) or White (WT).	12" x 7/8" x 9/16" (305 mm x 23 mm x 14 mm)
T-WM-90-Color	90" Plastic Wire Manager used to neatly conceal wire. Available in Black (BK) or White (WT).	90" x 3/4" x 3/8" (2286 mm x 19 mm x 9 mm)
T-WM-EC-Color	Elbow Connector to use with Plastic Wire Manager. Use to continue Plastic Wire Manager around the corner for an installation. Available in Black (BK) or White (WT).	1-1/2" x 1-1/2" x 1/2" (38 mm x 38 mm x 13 mm)
T-WM-ISC-Color	In-line Splice Connector. Used to connect two Plastic Wire Managers. Available in Black (BK) or White (WT).	1" x 7/8" x 7/16" (25 mm x 22 mm x 11 mm)



L-PFWW-BK-48



L-PFMJ-BK-12

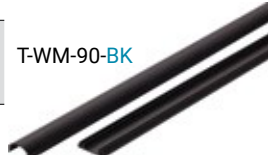

T-WM-90-BK

End Caps

Use with aluminum profiles

Part Number	Description	Dimensions
L-PFEC-Color	End caps for L-PFAP aluminum housing with wire entry openings. Available in Black (BK) or White (WT). Sold individually.	5/16" x 7/8" x 9/16" (8 mm x 23 mm x 14 mm)
L-EC-DM	End caps for L-DM aluminum housing with wire entry openings—Available in clear plastic. Sold individually.	11/16" x 5/8" x 1/2" (18 mm x 16 mm x 12 mm)
L-EC-002	End caps for L-002 aluminum housing with wire entry openings—Available in Light Grey. Sold individually.	1" x 5/16" x 7/16" (25 mm x 8 mm x 11 mm)
L-EC-002XL	End caps for L-002XL aluminum housing with wire entry openings. Available in Black (BK) or White (WT). Sold individually.	13/16" x 13/16" x 1/2" (21 mm x 22 mm x 12 mm)
L-EC-003	End caps for L-003 aluminum housing—Available in Light Grey only. Sold individually.	5/8" x 5/8" x 1/4" (16 mm x 16 mm x 6 mm)
L-EZV2-6PK-BK	Black screw-down connector 8 mm and 10 mm tape lighting—6 pack. Use to connect 8 mm or 10 mm tape light to wire.	3/4" x 7/16" x 5/16" (19 mm x 10 mm x 8 mm)
L-EZV2-100PK-BK	Black screw-down connector 8 mm and 10 mm tape lighting—100 pack. Use to connect 8 mm or 10 mm tape light to wire.	3/4" x 7/16" x 5/16" (19 mm x 10 mm x 8 mm)
L-EZV2-6PK-WT	White screw-down connector 8 mm and 10 mm tape lighting—6 pack. Use to connect 8 mm or 10 mm tape light to wire.	3/4" x 7/16" x 5/16" (19 mm x 10 mm x 8 mm)
L-EZV2-100PK-WT	White screw-down connector 8 mm and 10 mm tape lighting—100 pack. Use to connect 8 mm or 10 mm tape light to wire.	3/4" x 7/16" x 5/16" (19 mm x 10 mm x 8 mm)



L-PFEC-BK



L-EC-DM



L-EC-002



L-EC-003



L-EZV2

Bracket Support and Flange Set

Use with Lighted Closet Rod

Part Number	Description	Dimensions
L-LCR-HS-Color	Center hanging support bracket for Lighted Closet Rod. Recommended to use every 48". Available in Black (BK), Satin Nickel (SN) or White (WT).	2" x 1" x 2-3/16" (52 mm x 25 mm x 56 mm)
L-LCR-SS-Color	Center shelf support bracket for Lighted Closet Rod. Recommended to use every 48". Available in Black (BK), Satin Nickel (SN) or White (WT).	11-7/8" x 1" x 10-7/8" (302 mm x 25 mm x 276 mm)
L-LCR-FS-Color	Wall Flange set for Lighted Closet Rod. Available in Black (BK), Satin Nickel (SN) or White (WT).	2-3/4" x 1-1/2" x 11/16" (70 mm x 40 mm x 21 mm)



L-LCR-HS-SN



LC9R-SS-SN



L-LCR-FS-SN

3M™ Adhesion Promoter Wipe

Use with LED Tape Lighting

Part Number	Description	Dimensions
L-APW-4298	3M™ adhesion promoter wipe—cleans the surface for a stronger tape lighting adhesion bond	N/A



L-APW-4298

3M™ Adhesion Tape

Use with Linear Fixtures, Tape Lighting, or components

Part Number	Description	Dimensions
L-DSA200	Waterproof 3M™ 300LSE high-bond adhesion tape for secure tape light installation; 180 ft.	5/16" wide (8 mm)



L-DSA200

Mounting Clips

Use with aluminum profiles

Part Number	Description	Dimensions
L-MC-003	Mounting clip for L-003 aluminum profile—mounting screws included	9/16" wide (14 mm)
L-MC-007	Mounting clip for L-007 aluminum housing and L-DM Dual-Mount aluminum profile—mounting screws included	5/8" wide (16 mm)



L-MC-007

Product Samples Available

Check out our wide variety of product samples and place an order today!



View our Samples

Scan to go to see a list of our samples available
<https://delivr.com/2sy42>

Display Rebate Program



Earn your rebate in 3 easy steps

1. Purchase products

LED Lighting or Angle Power Strip

2. Achieve target purchase amount

3. Receive a full rebate

on products purchased for display

Item number DISP-LTPWR must be added on any order that qualifies. When you hit your qualifying target purchase amount, you will automatically receive the rebate. It will appear in your statement under the item number REBATES-LTPWR.

*Not hitting the amount in 12 months will forfeit the rebate.

Display LED Lighting for free in your showroom

Purchase and install any Task Lighting & Power products in a kitchen or closet vignette display in your showroom. Once you hit the predetermined target purchase amount, you receive a full rebate on those products!

As always, products purchased for display in vignettes receive an additional 35% off of dealer price or an additional 25% off displaying dealer price. If you are not aware already, dealers who display Task Lighting & Power in their showroom get an additional 10% off of **ALL** Task Lighting & Power purchases!

This rebate program includes all LED Lighting, Angle Power Strip products, and accessories offered by Task Lighting & Power. Sell these products to earn a rebate that makes your display **FREE**.

You have one year from date of purchase to hit the target purchase amount.*

Contact your representative for more details.

Rebate Structure

Display Parts Cost	Purchases Within 12 Months to Earn Rebate
\$0 – \$249	\$1,500
\$250 – \$499	\$3,000
\$500 – \$749	\$4,000
\$750 – \$999	\$5,000
\$1,000 – \$1,249	\$6,000
\$1,250 – \$1,500	\$7,000

Trial Order Program & Warranty

You Buy. You Try. You Decide.

Place a Trial Order for any new-to-you Task Lighting & Power products and try them out. If you're not satisfied we'll take them back. Guaranteed!

How the Trial Order program works

1. Place a Trial Order for any new-to-you Task Lighting & Power products and give them a try. Trial Orders can be combined with a regular order. We pay the freight on Trial Orders.
2. Test the products risk-free.
3. If you're not completely satisfied, call us. We'll give you immediate full credit on the Trial Order purchase. We'll arrange for the products to be picked up later—no need to save the original packaging, ship them back, etc. We make it easy. We would appreciate hearing your observations on the products.



How to order

1. Call **Customer Service at 800-445-6404**
2. Use code **TRIAL-TASKLIGHTING** for the Trial Order products

Warranty

Hardware Resources believes in quality, integrity, and reliability. We uphold the highest standards of service and responsibility in the industry.

As such, Hardware Resources warrants all Task Lighting & Power products against defects in material and workmanship brought to our attention within FIVE years for Lighting and Power fixtures and THREE years for Task Lighting & Power accessories, after purchase, if the original consumer purchased the products from an authorized distributor of Hardware Resources. Hardware Resources cannot guarantee the quality or condition of products from distributors who do not agree to meet our high standards, and therefore, no warranty is provided for products from unauthorized sellers.

If a defect is found within a certain time-frame (LED lighting: 5 years, Power: 5 years, WAV Smart Control™: 3 years, LED lighting accessories: 3 years), Task Lighting & Power will send to the original purchaser a new replacement product or component at no charge. If a replacement is no longer available, Task Lighting & Power will offer a replacement fixture or component that is comparable to the original product's purchased price.

This warranty is a warranty of replacement only. Hardware Resources specifically does not warrant removal of the product nor installation of replacement new product. This warranty does not apply when the item has been tampered with, misused, improperly installed (use of incorrect voltage, use of incorrect wire size and type), or damaged through improper cleaning, abuse, or accident. This warranty does not apply to slight variation in Kelvin temperature, normal in selection of LED diodes.

In the unlikely event that a defective Task Lighting & Power product, or a defective Task Lighting & Power accessory product is encountered, please contact Customer Service at 800-445-6404. Please be able to provide a brief description and photographs of the defect.



NORTH POINT CABINETS®





The NorthPoint Cabinetry Solution

NorthPoint Cabinetry features a wide array of **QuickBuild**® cabinet designs, providing value with a quality, custom look. Cabinets are in stock, shipping quickly from our strategically located warehouses across the U.S.

- Unique dovetail and pocket screw cabinet construction for sturdy and fast assembly
- Robust replacement parts program
- Free freight on most orders
- Dedicated customer service support



For more information, visit NorthPointCabinetry.com or scan the QR code.

With 6 dedicated warehouses across the country, NorthPoint Cabinetry typically ships within 48 hours and arrives in 2–3 business days.

The Quick Advantage

Ships QUICKLY, Assembles FAST

NorthPoint Cabinetry offers a **quick** advantage for you and your customer by making it fast and easy to design, order, ship & assemble cabinets. **Why does this matter?** With a reduction in time and labor, you can complete more jobs and see significant savings.

Some specific ways the NorthPoint Cabinetry Quick Advantage can save you time & money:

- **Quick to Design**

Our cabinets are available in 2020 and ProKitchen software, making kitchen design fast and easy.

2020



- **Quick to Order**

Place an order for your cabinets with our quoting tool, on our website at NorthPointCabinetry.com, or by contacting a live customer service agent.

- **Quick to Ship**

With 6 dedicated warehouses across the country, orders typically ship within 48 hours and arrive in 2–3 business days.



- **Quick to Assemble**

With our **QuickBuild**® cabinets, the average assembly time per cabinet is 8 minutes*; you can build a medium-sized kitchen in less than half a day.

Quality Comes First

You can trust NorthPoint Cabinetry for your customers. Our cabinets and hardware have gone through rigorous third-party testing and meet the KCMA standards. With quality details throughout and the features your customer will appreciate, NorthPoint Cabinetry is built to last.



It Starts with Quality Wood

Just as a healthy tree needs strong roots to thrive, a quality cabinet requires premium lumber at its core. The quality of wood is of utmost importance, so our cabinets feature all-wood construction.

Structural Integrity

Meaningful yet hidden reinforcements—like solid wood corner blocks and strategically placed pocket screws—help reinforce the structural integrity of the cabinet. Take comfort that these well-constructed cabinets will stand the test of time.



Thoughtful Craftsmanship

These cleverly designed cabinets boast an innovative dovetail and hidden pocket screw construction that provides robust quality and quick, accurate assembly.





Pretty on the Inside, Too

NorthPoint Cabinetry features a clean and beautifully finished birch interior that enhances the cabinet's luxurious, high-quality appeal.

Premium Drawer Boxes

Dovetail joinery is the hallmark of high-quality drawer boxes. The UV finish of the drawer boxes coupled with the dovetail construction, and smooth concealed slides are synonymous with quality furniture.



Hardworking Hardware

Our cabinets feature discreet compact hinges and concealed undermount slides. The hinges and slides have been third-party tested and exceed industry standards. The Premier Collection (shown) features full extension slides, allowing for easy access and use of the whole drawer.

Sturdy Shelves

NorthPoint Cabinetry shelves are constructed from an impressive $\frac{3}{4}$ " thick veneered plywood, preventing sagging over time under the weight of normal use. Shelf height is adjustable, so the homeowner can optimize storage space.

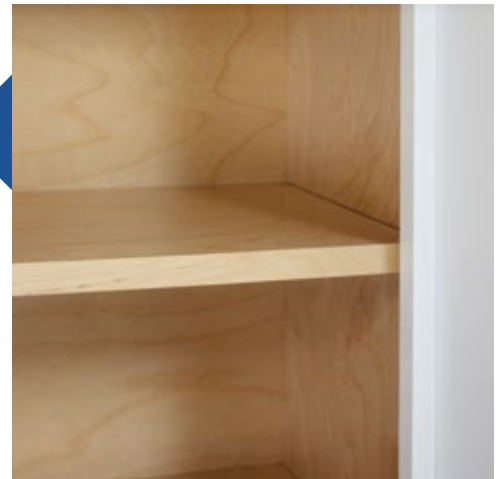

Expert Finishing

Count on consistent, high-quality finishing. Our state-of-the-art manufacturing facility utilizes a multi-step professional finishing process. This meticulous process maintains a high degree of color and application accuracy from cabinet to cabinet, ensuring a beautiful run of cabinets when installed.



ESPRESSO



SLATE



NEW SANDSTONE



PEBBLE GREY



POLAR WHITE

What are **QuickBuild**[®] Cabinets?



Dovetail + Pocket Screws = QuickBuild[®]

Basic assembly of our cabinets is as simple as sliding the panels together and securing with pocket screws. You don't need extra fasteners to hold the panels in place, and conveniently placed pocket screws will reduce the average time you spend on each cabinet.



How fast can you build a cabinet?

One of our cabinets takes about 8 minutes* to assemble (many do it in 4). You can build a kitchen or bathroom in record time!



Scan the QR code or go to <https://delivr.com/2kcvh> to view our Quick Assembly Video.

Our Collections



PREMIER Collection

The Premier Collection features elegant upgrades like soft-close doors and drawers.

Door Styles: Catalina, Maui

- 3/4" solid wood face frame & shelves
- 1/2" plywood cabinet construction
- Beautiful, finished interior
- 5-Year limited lifetime warranty





ESSENTIALS

Collection

The Essentials Collection delivers on style at an impressive value.

Door Style: Hatteras

- 3/4" solid wood face frame & shelves
- 1/2" plywood cabinet construction
- Beautiful, finished interior
- 1-Year limited lifetime warranty

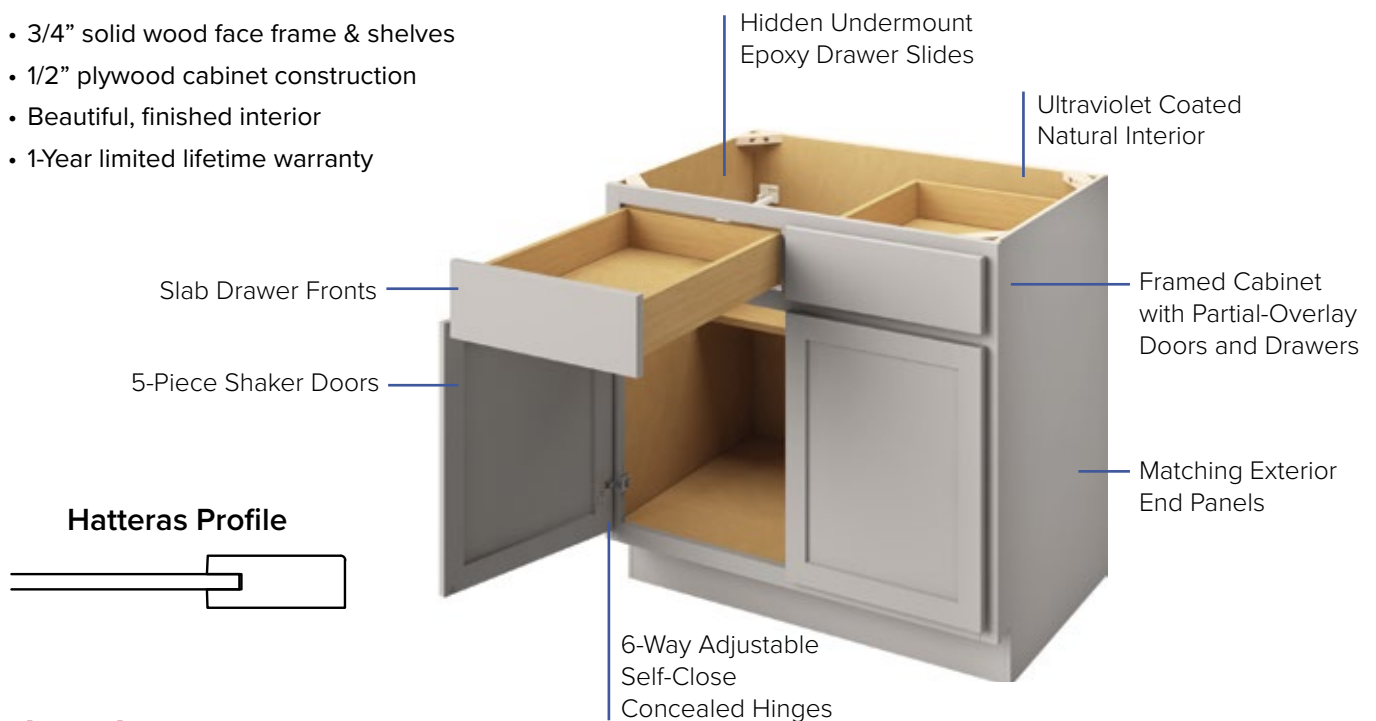

PREMIER COLLECTION: CATALINA





CATALINA FINISHES

More than modern. The Catalina door style features a full-overlay, Shaker-style door and 5-piece drawer front.

POLAR WHITE



PEBBLE GREY



ESPRESSO

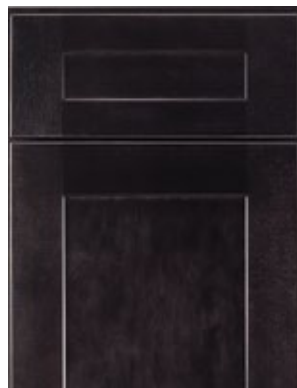

SLATE



NEW SANDSTONE



PREMIER COLLECTION: MAUI





MAUI FINISHES

Sometimes the details make all the difference. The Maui door style features a full-overlay, transitional-style door and 5-piece drawer front with a twist of character.



POLAR WHITE



PEBBLE GREY



ESPRESSO*



SLATE



**Call for availability*

ESSENTIALS COLLECTION: HATTERAS





HATTERAS FINISHES

Simple and sleek. The Hatteras door style features a partial-overlay, Shaker-style door and slab drawer front.



POLAR WHITE



PEBBLE GREY



ESPRESSO



NEW SLATE



Cabinets for Any Space

The kitchen and bath are common spaces to install cabinetry. However, NorthPoint Cabinetry provides solutions for other spaces like the laundry room, mudroom, and entertainment areas. Cabinets make those areas more functional by providing additional storage and countertop work space.



Wine Bar

Catalina Pebble Grey Cabinets

Decorative Cabinet Hardware: Marlo in Satin Nickel



Mudroom

Maui Polar White Cabinets
Decorative Cabinet Hardware:
Ella Collection in Brushed Oil
Rubbed Bronze
Decorative Hooks:
Emerald in Brushed Oil
Rubbed Bronze



Laundry Room

Catalina Slate Cabinets
Decorative Cabinet Hardware:
Hudson Collection
in Satin Nickel

Versatile Vanity Cabinets

Our kitchen and vanity cabinets are made with the same dependable quality and construction. The vanity door styles and finishes match our kitchen cabinet collections, which allows you to design coordinated spaces for your clients and create an intelligent design flow from kitchen to bathroom. Mix up the design styles and finishes from room to room if that best fits the design personality

We offer many different vanity cabinet configurations that allow our cabinets to perfectly fit most bathroom spaces. Options like linen cabinets and all drawer cabinets go the extra mile to make the bathroom space functional and beautiful.



Catalina Polar White Cabinets
Decorative Cabinet Hardware: Tahoe Collection in Black

Create Your Customer's Perfect Vanity

Our cabinets are designed to mix and match for a customized solution to fit your customer's lifestyle. Need more drawers? No problem. Prefer one sink and lots of counter space? We've got you covered. Here are some popular combinations to get you started designing the perfect vanity for your customer.

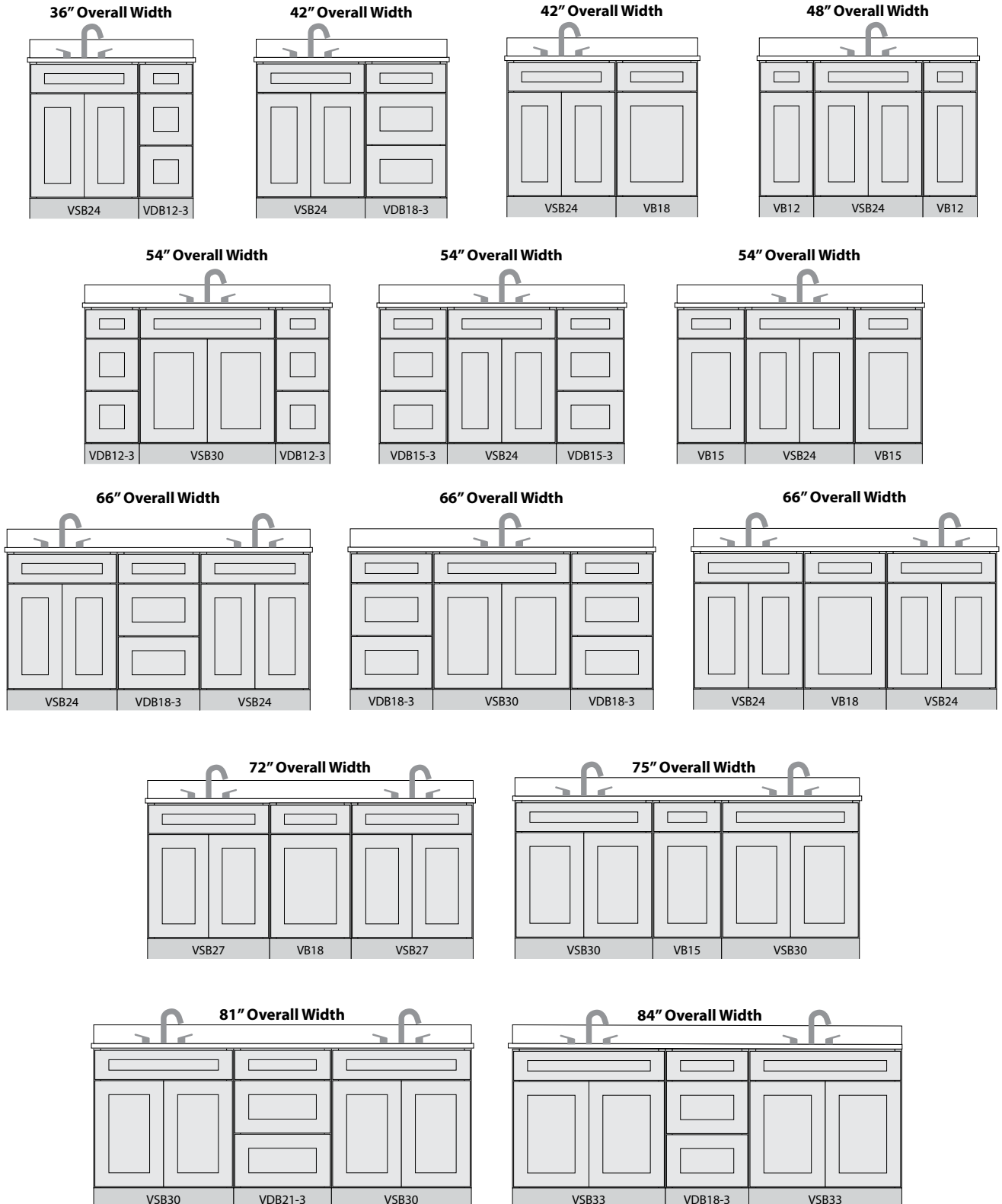

Catalina Polar White Cabinets
Decorative Cabinet Hardware:
Cordova in Satin Nickel
VBTD42





Maui Espresso Cabinets
 Decorative Cabinet Hardware: Bremen 2 in Gun Metal
 VSB30, VDB15-3 & VL1884



Maui Pebble Grey Cabinets
 Decorative Cabinet Hardware: Florence in Satin Bronze
 VSB24 & VDB12-3



Maui Polar White Cabinets
 Decorative Cabinet Hardware: Hayworth in Matte Black
 VSB24

Cabinet Lineup

WALL CABINETS

12" deep except where noted
 42" high wall cabinets will have 3 shelves
 *39" and 42" widths will have a vertical center stile unless otherwise noted

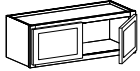

Double Door
 12" Height
 30", 33", 36",
 or *39" Width

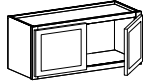

Double Door
 15" Height
 30", 33", 36",
 or *39" Width

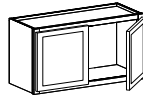

Double Door
 18" Height
 21", 24", 30", 33", 36",
 or *39" Width

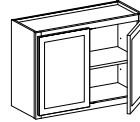

Double Door
 24" Height
 30", 33", 36", or *39" Width

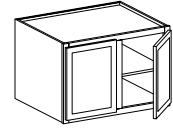

Deep Double Door
 18" or 24" Height • 24" Depth
 36" or *39" Width
 18" Height does not have shelf

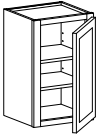

Single Door
 30" Height
 9", 12", 15", 18", or 21" Width

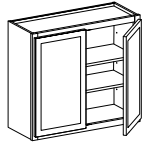

Double Door
 30" Height
 24", 27", 30", 33",
 36", *39", or *42" Width

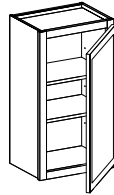

Single Door
 36" Height
 9", 12", 15", 18", or 21" Width

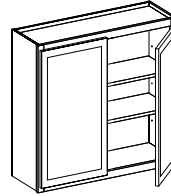

Double Door
 36" Height
 24", 27", 30", 33",
 36", *39", or *42" Width

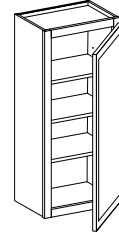

Single Door
 42" Height
 9", 12", 15", 18", or 21" Width

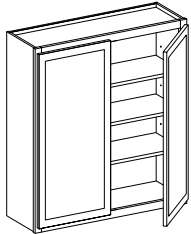

Double Door
 42" Height
 24", 27", 30", 33",
 36", *39", or *42" Width

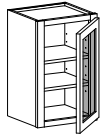

Single & Double Glass Door
 Matching Finish Color Interior
 30" Height
 15", 18", 30", or 36" Width

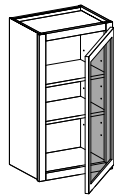

Single & Double Glass Door
 Matching Finish Color Interior
 36" Height
 15", 18", 30", or 36" Width

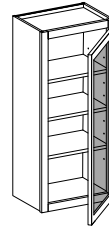

Single & Double Glass Door
 Matching Finish Color Interior
 42" Height
 15", 18", 30", or 36" Width

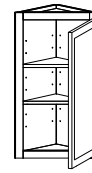

Wall End Single Door
 30", 36", or 42" Height
 12" Width

Glass door wall cabinets only available in the Premier Collection

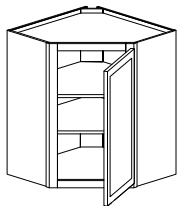

Diagonal Corner
 30", 36", or 42" Height
 12 or 15" Depth
 24" or 27" Width

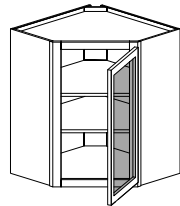

Diagonal Corner Glass Door
 Matching Finish Color Interior
 30", 36" or 42" Height
 12 or 15" Depth
 24" or 27" Width

Glass door wall cabinets only available in the Premier Collection

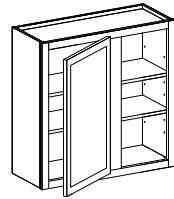

Universal Blind Corner
 30", 36", or 42" Height
 30"-33" Width

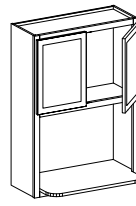

Microwave Wall Cabinet
 Extended Shelf
 36" Height
 30" Width

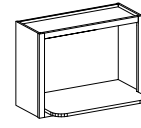

Microwave Wall Cabinet
 Extended Shelf
 18" Height
 30" Width

BASE CABINETS

24" deep, 34-1/2" high
 except where noted

*39" and 42" widths will
 have a vertical center stile
 unless otherwise noted

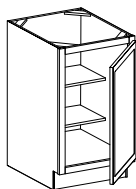

**Full Height
 Single Door**
 9", 12", 15", or 18" Width

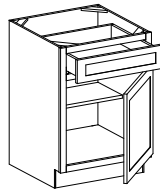

**Single Door
 and Drawer**
 12", 15", 18", or 21" Width

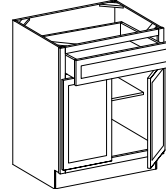

**Double Door and
 Single Drawer**
 24", 27", or 30" Width

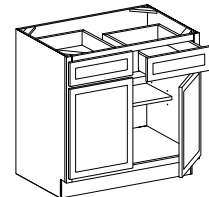

**Double Door and
 Double Drawer**
 33", 36", *39", or *42" Width

Thousands of Cabinet Options in Stock for Quick Delivery

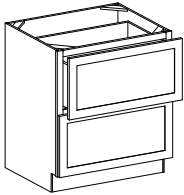

Double Drawer
30" or 36" Width

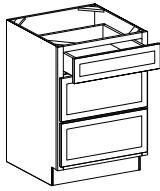

Triple Drawer
12", 15", 18", 21", 24", 30",
or 36" Width

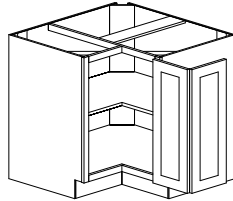

Base Corner Cabinet
33" or 36" Width
(Lazy Susan inserts available)

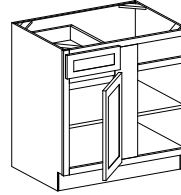

**Universal Blind
Base Corner**
39"–42", 42"–45", or
45"–48" Width

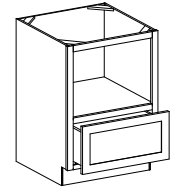

**Microwave Base
Cabinet with Drawer**
30" Width

SINK BASE CABINETS

24" deep, 34-1/2" high
except where noted.

*39" and 42" widths will
have a vertical center stile
unless otherwise noted

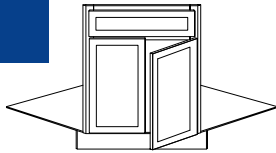

**Corner Sink Front
Double Door**
24" Depth
(2-piece bottom panel)

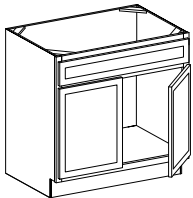

**Sink Base
Double Door**
30", 33", 36", or 39" Width

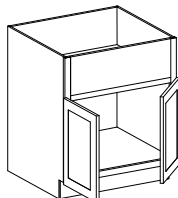

**Farmhouse Sink
Base Double Door**
36" or 39" Width
(No center stile)

TALL CABINETS

24" deep except
where noted.

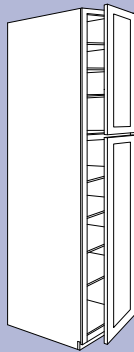

**Utility/Pantry
Single Door**
84", 90" (6 shelves),
or 96" Height (7 shelves)
18" Width

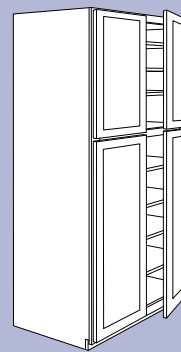

**Utility/Pantry
Double Door**
84", 90" (6 shelves),
or 96" Height (7 shelves)
24" or 30" Width

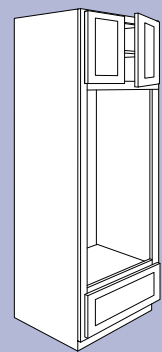

**Oven Double Door,
Single Drawer**
84", 90", or 96" Height
33" Width
*Single shelf in 96" only
(Double Oven Overlay Panel available)

VANITY CABINETS

21" deep, 34-1/2" high
except where noted

*42" widths will have a
vertical center stile

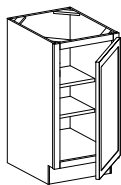

Single Door
12" Width

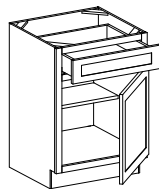

**Single Door
and Drawer**
12", 15", or 18" Width

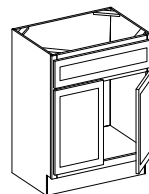

Double Door
24", 27", 30", 33",
or 36" Width

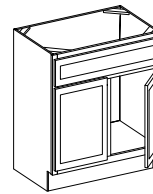

**Double Door
Center Stile**
42" Width

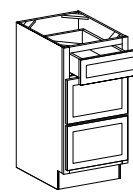

Triple Drawer
12", 15", 18", or
21" Width

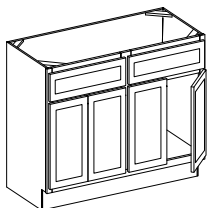

Two Double Door
48" Width

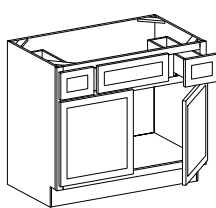

**Double Door and
Double Drawer**
36", 42", or 48" Width

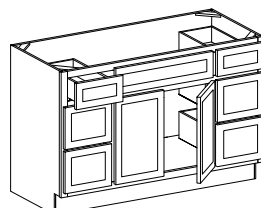

**Double Door and
Six Drawer**
60" Width

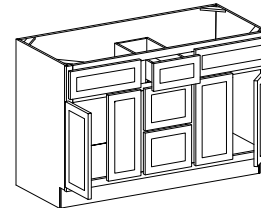

**Two Double Door and
Triple Drawer**
60" Width

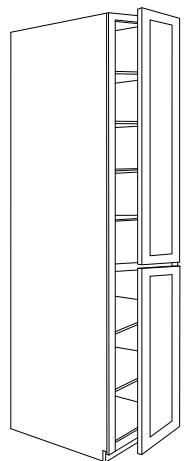

**Linen Single &
Double Door**
84" (6 shelves)
Single: 15" and 18" Width
Double: 24" Width

Complete the Look with Accessories

Add the finishing touch to your customer's cabinets with our broad selection of cabinet accessories. Whether your client's ideal space is traditional, transitional, or contemporary, we have the selection available to transform the space from ordinary to extraordinary.



MOULDING

Crown, toe kick, light rail, scribe, and accent moulding options available

Available in all finishes:

Polar White, Pebble Grey,
Espresso, Slate, and Sandstone

OVERLAY FILLERS

Fluted and smooth options available

Available in all finishes:

Polar White, Pebble Grey,
Espresso, Slate, and Sandstone





DECORATIVE PANELS

Available in all finishes:
Polar White, Pebble Grey,
Espresso, Slate, and Sandstone

DECORATIVE WOOD

Available in all finishes & door styles:
Polar White, Pebble Grey,
Espresso, Slate, and Sandstone



SPECIALTY CABINETS

Available in all finishes:
Polar White, Pebble Grey,
Espresso, Slate, and Sandstone



Knobs & Pulls

JEFFREY ALEXANDER[®]
by Hardware Resources

E L E M E N T S[®]
by Hardware Resources

Cabinets from NorthPoint Cabinetry are not complete without Jeffrey Alexander or Elements cabinet knobs and pulls! Your clients can personalize their space—really bringing their style to life. Cabinet knobs and pulls often take center stage by adding the finishing touch on the perfect design. There are **1,000s of different knobs and pulls for your clients to choose from** in various sizes, finish options, and price points so that they can achieve that perfect look.

See our full offering of cabinet knobs & pulls on pages 7–212.



Satin Nickel Pulls

Leyton from Jeffrey Alexander
Maui Espresso Cabinets



Matte Black Pulls

Wheeler from Jeffrey Alexander
Catalina Polar White Cabinets



Satin Bronze Pulls

Thatcher from Elements
Catalina Espresso Cabinets



Brushed Gold Pulls

Naples from Elements
Hatteras Polar White Cabinets

Create an Organized & Efficient Kitchen

Cabinet design is not only about aesthetics—functionality of the space is an important factor. Improve your client's experience with Organizers that conquer clutter and make reaching items easy and efficient. See our full offering of Organizer products on pages 301–492.

Neatly Tuck Away Trash Cans

Pick a trash can solution that best fits your kitchen and your budget.

- Wood Bottom Mount Trash Can
- Economy Soft-Close Trash Can
- Storage with Style® Trash Can Pullout



✓ POPULAR



✓ POPULAR



Organization Within Reach

Maximize cabinet storage with base cabinet organizers. Choose pullout organizers to maximize storage and eliminate the reach.

- "No Wiggle" Base Pullout
- Mixer Lift
- Storage with Style® Base Pullout



For more information on cabinet organizers, scan the QR code or visit delivr.com/272ju

See the NorthPoint Cabinetry Cross Reference Guide in the NorthPoint Cabinetry Spec Book to determine which organizers fit in each cabinet.



Corner Storage That Comes To You

Bring the deep recesses of corner cabinets forward with corner organizers.

- Easy 360 Susan
- Half-moon Lazy Susan
- Storage with Style® Blind Corner Pullout

Tame Drawer Clutter

Drawer inserts help organize everything from cutlery to spices to dishes.

- Cutlery Drawer Insert
- Spice Rack Drawer Insert
- Coffee Pod Drawer Insert

✓ POPULAR



Organize Heavily Used Cabinets

Go from disorder to order with solutions for challenging storage areas.

- Easy Access Pantry Pullout
- Double Drawer Bottle Rollout
- Storage with Style® Pullout Baskets

Add Lighting to Brighten the Kitchen



Highlight the beauty of your cabinet design with LED lighting from Task Lighting & Power. Select from a variety of assembled linear fixtures, tape lighting, puck lights, and specialty lighting—allowing your clients to set the mood in any room.

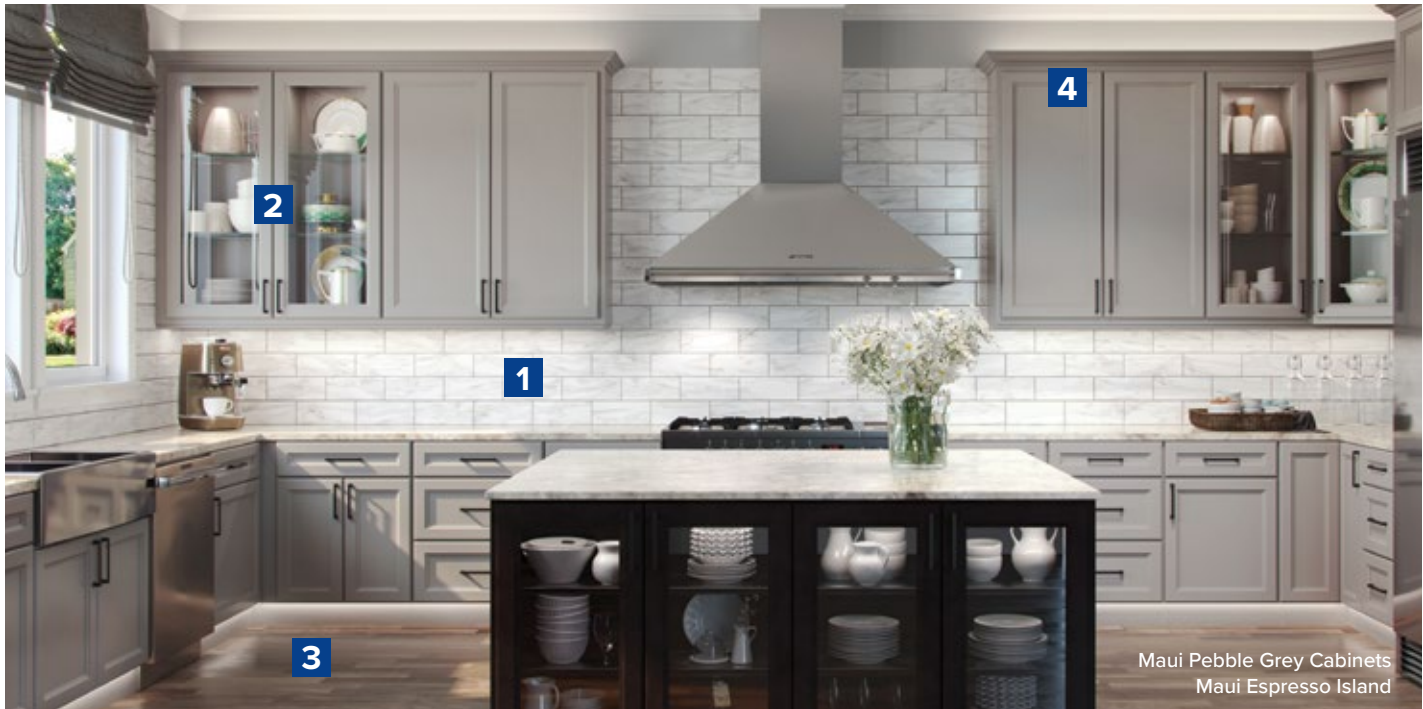

1 *Illuminate countertops with Under Cabinet Lighting*

Illuminate countertops with under cabinet lighting to enhance functional spaces, highlight beautiful backsplashes, or eliminate shadows created from cabinets. Under cabinet lighting creates ample illumination for meal prep and reading recipes.

2 *Accentuate decorative items on display with In Cabinet Lighting*

Use lighting in glass-faced cabinets to accentuate decorative items on display or highlight beautiful crystal and china. Adding lighting inside a glass door cabinet gives a nice wash of light throughout the cabinet.

3 *Highlight beautiful flooring with Toe Kick Lighting*

Add lighting under the toe kick to highlight beautiful flooring during the daytime. At night, keep floors safely illuminated with a gentle glow for midnight snacking.

4 *Add ambiance and make the space feel larger with Above Cabinet Lighting*

Add depth and ambiance to your kitchen by highlighting the open space above cabinets to increase the aesthetic appeal and make the space feel larger.





Linear Fixtures available in 14 lengths to fit under cabinets 9”–48”



Angled Linear Fixture

Install under or in a cabinet to angle the light where it's needed.



Flat Linear Fixture

Install under a cabinet to illuminate the workspace below.



Recessed Linear Fixture

Recess into a frameless cabinet or shelf for a flush, sleek finish.

- No assembly required—fixtures snap into single-screw mounting clips for secure installation
- Designed to fit standard cabinet widths for simplified ordering
- Select between 3000K or 4000K for single-white or select tunable-white lighting for 2700K–5000K and all Kelvin temperatures in between
- Easy two-wire connection at either set of terminals
- Dimmable with wireless, wired, or Smart Home enabled control
- The economical choice—great price, fast installation, uses regular wire, not jumpers

ASSEMBLED
IN THE
USA

For more information on Linear Fixtures, see the Task Lighting & Power section on pages 493–600.

Don't know where to start?

Get connected with one of our friendly in-house Design Services team members to help you pick out the lighting products that will work best in the space.

866.848.9094

DesignAndSupport@TaskLighting.com

Hide Unsightly Power Outlets



Angle Power Strip fixtures tuck away hidden power right where it's needed and are the perfect alternative to standard outlets that disrupt the beauty of glass, tile, or solid-surface backsplashes.



18" Black fixture* with USB charging outlets



18" Satin Nickel fixture* with USB charging outlets



18" Bronze fixture* with USB charging outlets



18" White fixture* with USB charging outlets

ASSEMBLED
IN THE USA



5 YEAR
WARRANTY



For more information on Angle Power Strip fixtures, scan the QR code or visit www.TASKLighting.com

*Available in standard lengths from 9" to 72", custom options available



Tucked away electrical power, plus switches to control lighting, garbage disposal

Lighted Power Strip
Combines LED lighting and angled power outlets

ASSEMBLED
IN THE USA

Hatteras Polar White Cabinets, Hatteras Pebble Grey Island
Decorative Cabinet Hardware: Naples Collection in Brushed Gold



Angle Power Strip tucked up under the cabinet preserving the backsplash (and "disappears" when standing)

ELIMINATE THOSE UNSIGHTLY POWER OUTLETS WITH SLEEK, HIDDEN ANGLE POWER STRIP FIXTURES



Light & Power come together, out of sight beneath cabinets, with Lighted Power Strip fixtures. Now available with tunable-white lighting!

Lighted Power Strip tuned to Warm White 2700K

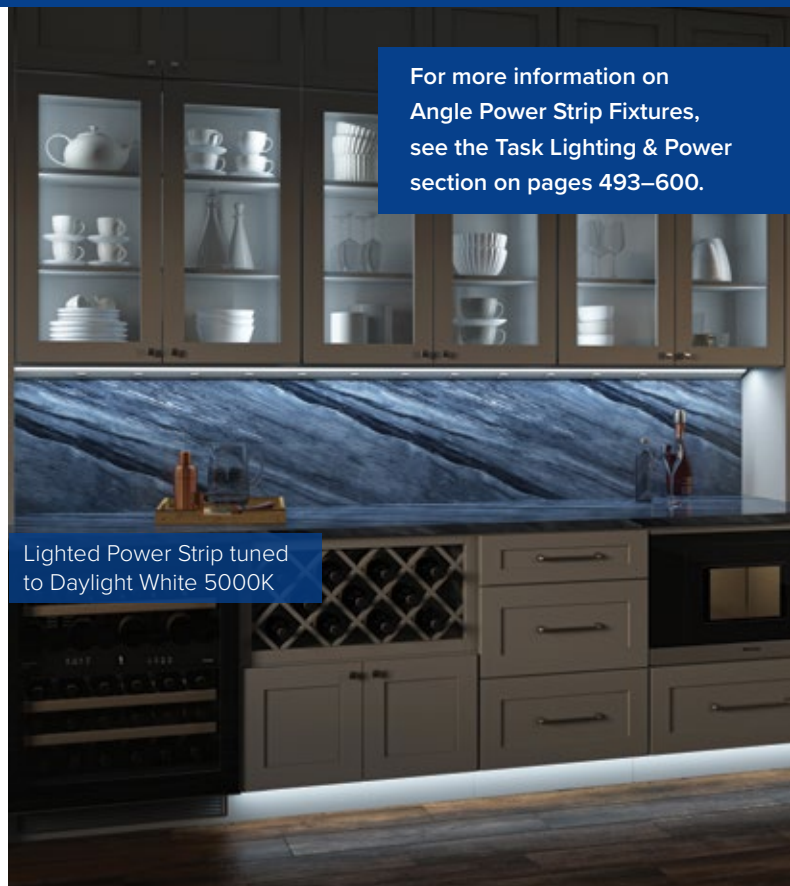

For more information on Angle Power Strip Fixtures, see the Task Lighting & Power section on pages 493–600.

Lighted Power Strip tuned to Daylight White 5000K

Resources

Assembly Videos



Base Cabinets
delivr.com/2s43x



Base Corner Cabinets
delivr.com/2r23p



Utility/Pantry Cabinets
delivr.com/29fgn



Double Oven Cabinets
delivr.com/28pgy

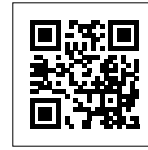

Wall Cabinets
delivr.com/25hbr



Wall Corner Cabinets
delivr.com/2d3s3



Wall End Cabinets
delivr.com/2krhy



Vanity Trim Kits
delivr.com/23n8d



Cabinet Rollout Tray
delivr.com/2fzzv

NorthPoint Cabinetry Videos



NorthPoint Brand Overview
delivr.com/2nyhg



Anatomy of a Cabinet
delivr.com/2zmba



Quick Advantage
delivr.com/2tuhn



Quick Assembly
delivr.com/2kcwh

Literature & Samples

Available on the Resources section of our website.



Homeowner Catalog



Homeowner
Selection Guide



Spec Book



Price Book

Also available:
Touch Up Kits (not shown)



Mini Base Cabinets
12" W x 21" H x 15" D



Sample Door Kit



Moulding Sample Kit



Finish Sample Kit

Freestanding Selection Center

Make selection easy with a curated line of quality cabinets. Personalize cabinet designs with a wide offering of decorative & organization products.



- One cabinet in each door style
- Door samples with informational backers
- Moulding sample boards
- Marketing materials included—catalog, spec book, and homeowner brochure
- Trending matte black finish hardware from the Hayworth Collection by Jeffrey Alexander
- Optional add-ons for decorative hardware and organizers
- Some assembly required

Ask your local sales representative about our display program and how to order a selection center for your showroom.

Ordering Made Easy

NorthPoint Cabinetry offers 3 convenient methods for easy order placement. We recommend placing orders online for faster processing and delivery and to easily confirm products are in stock.

1. Online: www.NorthPointCabinetry.com
2. Email: Orders@NorthPointCabinetry.com
3. Fax: (318) 742-9513

Order Placement

Place your online order by visiting www.NorthPointCabinetry.com. Login, select the items you wish to order, and simply checkout.

To order by email or fax, obtain a cabinet order form by logging in to the website, or request a form from a Customer Service team member or your sales representative. Submit the completed order form to the email address or fax number listed above. 2020 and ProKitchen material lists are also accepted as long as NorthPoint Cabinetry's item number nomenclature is used.

For questions about your order, call (800) 463-0660. Our friendly customer service agents are available to help you from 7am until 6pm Central Time.

Order Processing

Orders will be ready for pickup two hours after you have received your order confirmation email. Will Call orders are available for pickup at our facilities between the hours of 8am and 4pm local warehouse time. Should you have any questions about picking up your order or need to have the order modified in any way, contact your customer service representative. All requests for returns must be made within 60 days of invoice date. Returns are subject to a 20% restocking fee unless the return is due to Hardware Resources' error or a quality issue.

Returns

To request a Return Goods Authorization (RGA) contact Customer Service.

1. Phone: (800) 463-0660
2. Fax: (318) 742-9513
3. Email: ReturnRequest@HardwareResources.com

Include the item number, quantity and reason for return when requesting an RGA. Items should be in original packaging, unassembled, and shipped with care to avoid damage. Items received with damage may not be credited.

In the event that the return is due to an error by Hardware Resources, a return shipping label will be provided. Otherwise, shipments are the Customer's responsibility (including shipping fees) and should be shipped via a method which allows shipment tracking and proof of delivery.

Warranty

Premier Collection

Hardware Resources warrants to the original consumer purchaser that our Premier Cabinetry will be free from unnatural defects in material and workmanship under normal use and proper care for the period of FIVE (5) YEARS from the date of original purchase. This Limited Warranty applies only to the Original Purchaser and is not transferable to any other party.

WARRANTY COVERAGE

Limited 5-Year Warranty on Cabinets to the original purchasing consumer from the date of original purchase that the cabinets will be free from defects in material and workmanship under normal use and proper care. Limited Lifetime Warranty on Drawer Slides and Hinges to the original purchasing consumer as long as they own the product. We warrant that the drawer slides and hinges shall be free from defects in material and workmanship under normal use.

Essentials Collection

Hardware Resources warrants to the original consumer purchaser that our Essentials Cabinetry will be free from unnatural defects in material and workmanship under normal use and proper care for the period of ONE (1) YEAR from the date of original purchase. This Limited Warranty applies only to the Original Purchaser and is not transferable to any other party.

WARRANTY COVERAGE

Limited 1-Year Warranty on Cabinets and on Drawer Slides to the original purchasing consumer from the date of original purchase that the cabinets will be free from defects in material and workmanship under normal use and proper care. Limited Lifetime Warranty on Hinges to the original purchasing consumer as long as they own the product. We warrant that the drawer slides and hinges shall be free from defects in material and workmanship under normal use.

Don't miss our functional & wood products



CABINET HINGES



DRAWER SLIDES



DECORATIVE WOOD & MOULDING

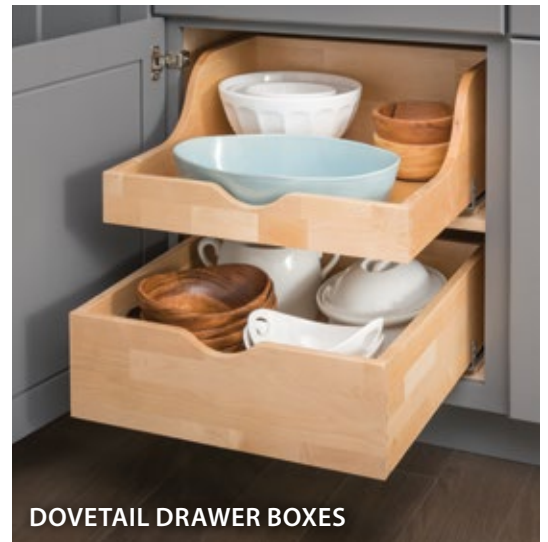

DOVETAIL DRAWER BOXES



See these products online at
www.HardwareResources.com

Contact your Hardware Resources Sales Representative for more information and printed literature or check out the digital versions on the catalogs page of our website
www.HardwareResources.com/HR-catalogs

From crown moulding to feet...

We offer a wide variety of decorative wood products

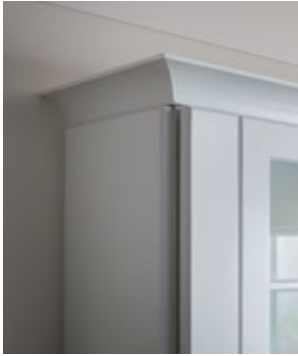

Corbels



Moulding



Onlays & Appliques



Posts & Fireplace Corbels



Feet & Legs



See product details in the Functional Hardware & Wood Products Catalog

From slides to fasteners...

We have the quality you need at the value you deserve

Drawer Slides



Undermount Slides



Ball-Bearing Slides



Epoxy Slides

Cabinet Hinges

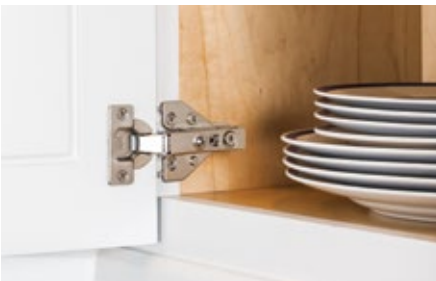

European Hinges



Compact Hinges



Specialty & Decorative Hinges

Accessories

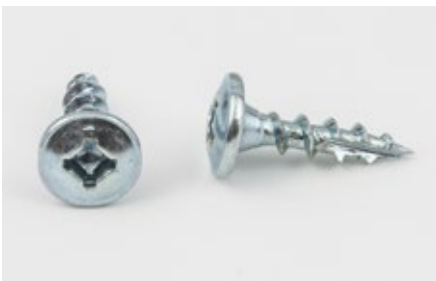

Screws



Brackets



And much more!

See product details in the Functional Hardware & Wood Products Catalog

Everything you need for a **beautiful** and **organized** kitchen, bath, closet and more



KNOB & PULLS

ORGANIZATION

SINKS

CABINETS

LED LIGHTING & POWER



Dimora Brands operates leading brands in cabinet hardware, functional hardware, door hardware, faucets, vanities, organizers, decorative wood, lighting, accessories, and related products. Its two operating divisions, Top Knobs and Hardware Resources, are known for the industry's best product offering and service. Each Dimora Brands division proudly serves kitchen cabinet dealers, kitchen and bath showrooms, custom cabinet makers, independent hardware stores, other customers, and the design community. Dimora Brands' collection of industry-leading brands includes: Top Knobs, Atlas Homewares, Vesta, Watermark Designs, Water Street Brass, Du Verre, Hardware Resources, Jeffrey Alexander, Elements, Task Lighting, NorthPoint Cabinetry and KasaWare. More information is available at DimoraBrands.com.

The Dimora Brands collection of industry-leading brands includes the following:



Policies and Procedures

ORDERING

- Website: www.HardwareResources.com
- Phone: (800) 463-0660
- Fax: (318) 742-9513
- Email: CustomerService@HardwareResources.com
- Mail: 4319 Marlena Street, Bossier City, LA 71111
- Customer Service is available from 7:00 am until 6:00 pm Central Time
- \$25 order minimum unless purchasing items as part of our Preferred program
- Your Will Call order will be ready for pickup two hours after you have received your order confirmation email. Will Call orders will be available for pickup between the hours of 8 am and 4 pm local warehouse time. Should you have any questions about picking up your order, contact Customer Service.
- Contact Customer Service to request a modification to an existing order. Modifications may not be possible if your order is already in process in our warehouse.

The Hardware Resources website allows you to place an order, track shipments, view and make payments, download price lists, add additional website users and offers many other features.

RETURNS

All requests for returns must be made within 60 days of invoice date. Returns are subject to a 20% restocking fee unless the return is due to Hardware Resources' error or a quality issue.

To request a Return Goods Authorization contact Customer Service.

- Phone: (800) 463-0660
- Fax: (318) 742-9513
- Email: ReturnRequest@HardwareResources.com
- Include the item number, quantity and reason for return when requesting an RGA

Items should be in original packaging and shipped with care to avoid damage. Items received damaged may not be credited.

In the event that the return is due to an error by Hardware Resources a return shipping label will be provided. Otherwise, shipments are the Customer's responsibility and should be via a method which allows shipment tracking and proof of delivery.

MINIMUM ADVERTISED PRICE (MAP) POLICY

Hardware Resources has a strict internet MAP (Minimum Advertised Price) Policy. Our policy is a maximum 10% discount off of our current List Price across all Hardware Resources brands and products for sale on the internet.

The only exception to the MAP policy is for products Hardware Resources has designated on our HardwareResources.com website as Discontinued.

Hardware Resources is committed to proactively seeking out, finding, and dealing with Internet MAP Policy violators. Customer websites are checked during weekdays, and also checked evenings and weekends to find violations outside of regular business hours. We strive to find and fix MAP violations before we hear a complaint from a Customer. Policy violations result in suspensions and customer terminations, and we do several such terminations each year.

Selling Hardware Resources brands and products online requires prior approval before listing items for sale on a website and/or marketplace. Please reach out to your sales rep for more information.

Log into your account on www.HardwareResources.com for a more detailed listing of our Policies and Procedures.



Jeffrey Alexander Jubilee Vanity Collection in Natural Oak shown

Want more inspiration? Find us on social media!



DESIGN by *hardwareresources*[®]

A BLOG FOR THE DESIGN COMMUNITY

<https://blog.hardwareresources.com>

Acct # _____

Website Login _____

Website Password _____

hardware
resources[®]

4319 Marlena St, Bossier City, LA 71111

www.HardwareResources.com

800.463.0660 • fax 318.742.9513



CATSRM24-1
9-2023